

Experimental Study of Prestressed Timber Columns under Bi-directional Seismic Loading

A. Iqbal, S. Pampanin & A. H. Buchanan

Department of Civil Engineering, University of Canterbury, Christchurch.



2008 NZSEE
Conference

ABSTRACT: Structural members made of laminated veneer lumber (LVL) in combination with unbonded post-tensioning have recently been proposed, which makes it possible to design moment-resisting frames with longer spans for multi-storey timber buildings. It has been shown that prefabricated and prestressed timber structures can be designed to have excellent seismic resistance, with enhanced re-centring and energy dissipation characteristics. The post-tensioning provides re-centring capacity while energy is dissipated through yielding of mild steel dissipating devices.

This paper summarizes an experimental investigation into the seismic response of LVL columns to bi-directional seismic loading, performed as part of a research programme on timber structures at the University of Canterbury. The experimental investigation includes testing under both quasi-static cyclic and pseudo-dynamic protocols. The results show excellent seismic performance, characterized by negligible damage of the structural members and small residual deformations, even under the combined effect of loading in two orthogonal directions. Energy is dissipated mostly through yielding of external dissipators connecting the column and the foundation, which can be easily removed and replaced after an earthquake. Since post-tensioning can be economically performed on site, the system can be easily implemented in multi-storey timber buildings.

1 INTRODUCTION

Current seismic design philosophies for multi-storey buildings emphasize the importance of designing ductile structural systems which undergo cycles of inelastic displacement during earthquakes, resulting in some residual damage but no significant reduction in strength. Innovative solutions have been developed under the U.S. PRESSS (PREcast Structural Seismic Systems) programme coordinated by the University of California, San Diego (Priestley 1991, 1996, Priestley et al. 1999) for the seismic design of multi-storey precast concrete buildings. Such solutions are based on joints between prefabricated elements with unbonded post-tensioning. As a result, efficient structural systems are obtained, which can undergo large inelastic displacements, while limiting the damage to the structural system and assuring re-centring capability after the seismic event. A particularly efficient solution is provided by the “hybrid” system (Stanton et al. 1997) where an appropriate combination of self-centring (unbonded tendons plus axial load) and energy dissipation (mild steel dissipating devices) produces a controlled rocking motion, characterized by a “flag-shaped” hysteresis loop (Fig. 1).

The hybrid concept has been recently implemented in timber structures (Palermo et al 2005). For multi-storey timber construction, LVL, fabricated from sheets of veneer glued into panels, is a suitable material since it has a higher level of homogeneity and superior strength than rough sawn or glue laminated timber. As part of a comprehensive research investigation for the development of innovative seismic resisting systems for multi-storey timber construction, a number of different frame and wall systems have been successfully tested under uni-directional loading (Palermo et al 2006a,b,c, Smith et al. 2007).

In a practical multi-storey building frame, the columns, especially the corner columns, are often subjected to displacements in two directions simultaneously. Therefore, it was necessary to test

columns under bi-directional loading. A series of tests on cantilever timber columns connected to a steel foundation have been carried out. Both post-tensioned only solutions and hybrid solutions with external dissipators were investigated for the specimen. The experimental results for the column-to-foundation subassembly under bidirectional cyclic quasi-static and pseudo-dynamic loading are presented here. The results are discussed to evaluate the performance of the hybrid connections.

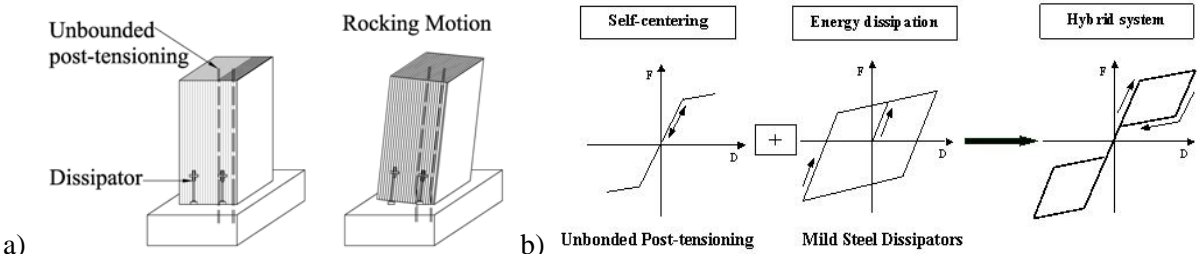

Figure 1: a) Hybrid connection and rocking motion; b) flag-shaped hysteresis behaviour (NZS3101:2006)

2 PROPERTIES OF THE SPECIMENS TESTED

The LVL used for the column is Hy90 (Futurebuild 2003), manufactured in accordance with AS/NZS 4357. For limit states design to the New Zealand Standard, NZS 3603 (1996), Hy90 characteristic strengths are given in Table 1.

Table 1. Material Properties of Hy90 LVL (Futurebuild 2003).

Modulus of Elasticity Parallel to Grain	E	9000	MPa
Bending Strength	f _b	35	MPa
Tension Strength Parallel to Grain	f _t	19	MPa
Compression Strength Parallel to Grain	f _c	28	MPa
Compression Strength Perpendicular to Grain	f _p	10	MPa

The specimen was originally designed as a timber bridge pier to have the moment capacity close to that of a concrete bridge pier tested as part of a recent research project at University of Canterbury. However, it can be argued that it was representative of a column from a multi-storey timber building. The column was constructed to have a hollow section by gluing together four Hy90 standard beam sections, each with a width of 360mm and thickness of 90mm (Fig. 2) to make a column 450mm square. The hollow timber column could be upgraded to higher axial load capacity for high-rise building structures by either making the cavity smaller or adding high strength concrete infill while maintaining the unbonded post-tensioning arrangement. For commercial production it will be preferable to use the arrangement shown in Fig. 2(b) for a large cavity or Fig. 2(c) for a small cavity, because both of these can be manufactured in a standard press.

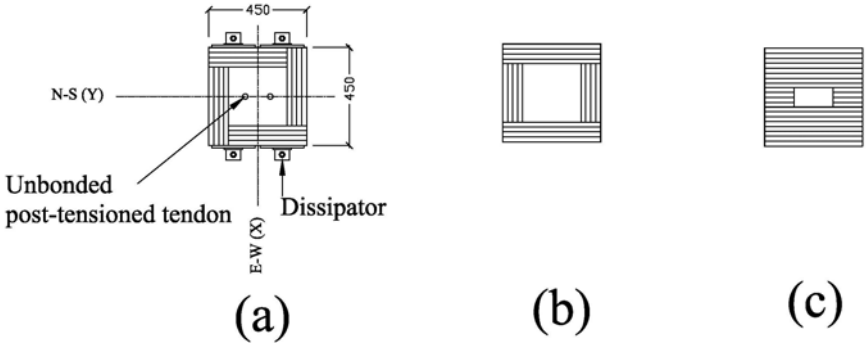

Figure 2: Column dimensions and component layup

3 TEST SET-UP AND LOADING REGIME

A series of tests was carried out with a single column with alternate arrangements subjected to bi-directional loading. There was no additional axial load applied, and the initial post-tensioning in the two tendons was designed to include some axial force due to gravity load. The bottom end of the timber column was placed directly on the steel foundation. No attempt was made to increase the bearing strength of the bottom end of the column. The post-tensioning tendons were anchored in a steel plate at the top of the column, and under the steel foundation at the bottom. There was no other contact between the tendons and the column. The cantilever column was horizontally loaded at the expected point of contra-flexure within a frame system, i.e. the mid-level of the inter-storey height (Fig. 3). The quasi-static loading protocol (Fig. 4a) consists of three cloverleaf-shaped cycles of increasing inter-storey drift, following the acceptance criteria for moment-frames proposed by the ACI T1.1-01 and ACI T1.1R-01. The load was applied simultaneously from two orthogonal directions through hydraulic actuators (Fig. 4b).

Mild steel energy dissipators (Fig. 4c) were added to the column for the hybrid tests. The energy dissipators consist of steel rods designed to yield in both tension and in compression. The 8mm diameter rods are encased in steel tubes injected with epoxy to prevent buckling in compression. The top end of each external dissipator was connected to an external steel case fixed to the LVL column, and the bottom end was fixed to the steel foundation.

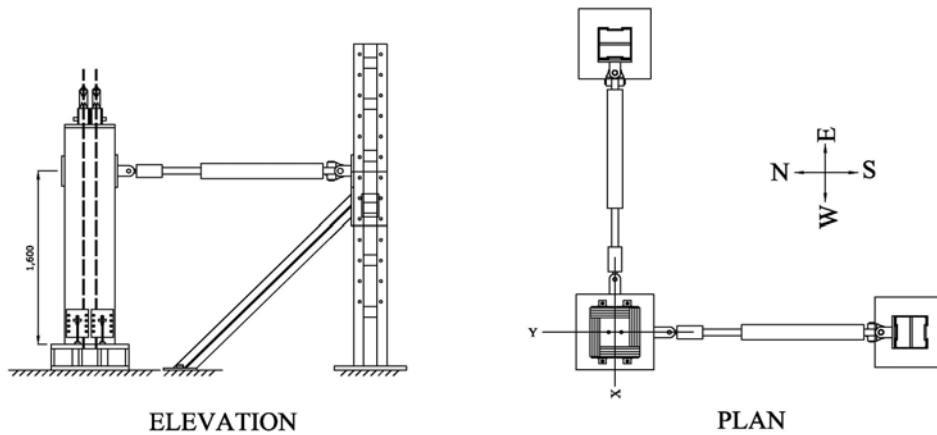

Figure 3: Test setup

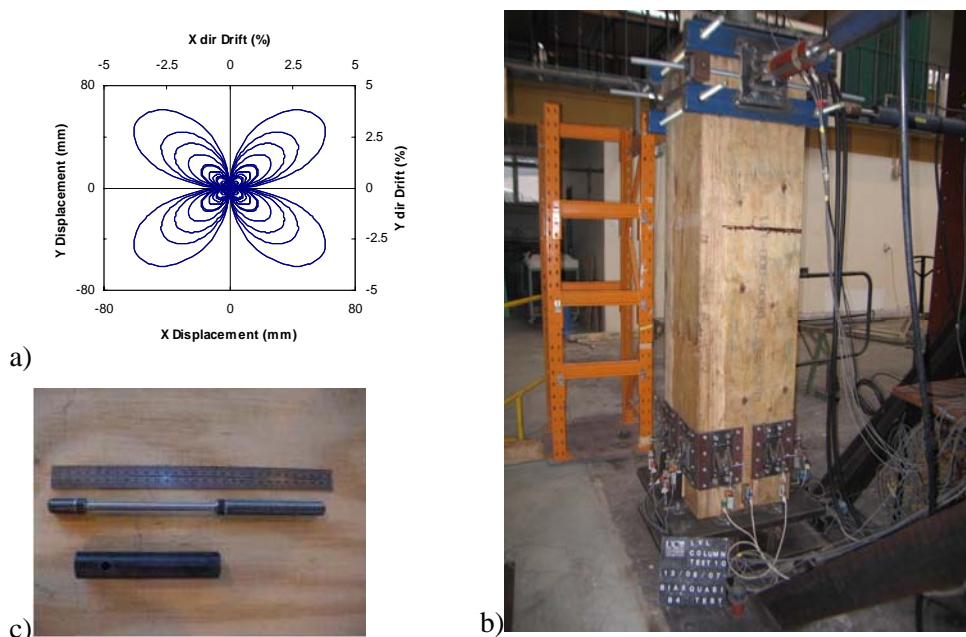

Figure 4: a) Loading protocol; b) testing arrangements; c) energy dissipators

4 QUASI-STATIC TESTS

Within the series of tests the column was tested with post-tensioning only and with different arrangements of dissipators to compare the recentering and dissipation characteristics of the different combinations as reported in Table 2. Figure 5 shows the details of the arrangements.

The specimen PT was tested with unbonded post-tensioning and no energy dissipators. The grey lines on Figure 6(a) and Figure 6(b) illustrate the recorded values of lateral force vs. drift in the N-S and E-W directions respectively. The tendon force vs. drift is shown in Fig. 7(a). It is obvious that there is some energy dissipation due to small inelastic deformations at the base of the column.

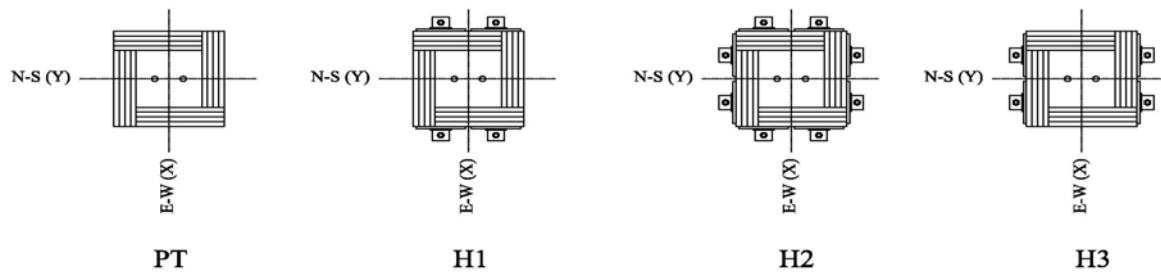

Figure 5: Details of specimens with designations

Table 2. Type and Properties of Specimens Tested.

Specimen Type/ Designation	Post-tensioned only PT	Hybrid H1	Hybrid H2	Hybrid H3
Geometry	450 X 450	450 X 450	450 X 450	450 X 450
Initial Post-tensioning	145.0 kN (two tendons at 72.5 kN)	145.0 kN (two tendons at 72.5 kN)	87.0 kN (two tendons at 43.5 kN)	87.0 kN (two tendons at 43.5 kN)
Dissipation	None	4-8mm diameter	8-8mm diameter	4-8mm diameter

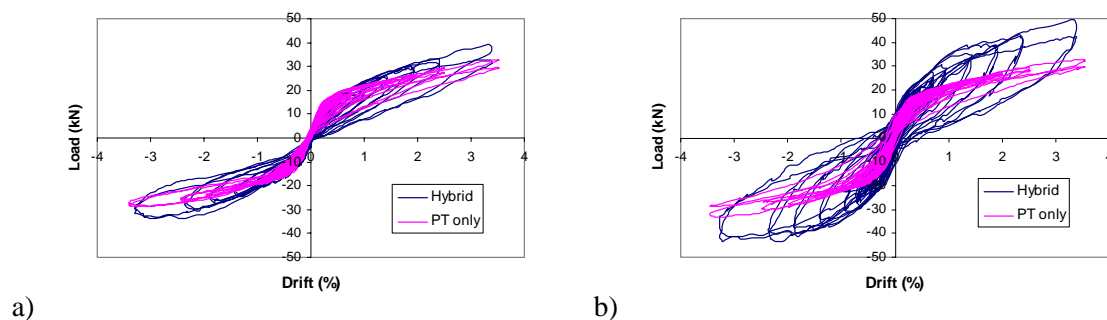

Figure 6: Load-displacement plots of specimens PT and H1 a) N-S direction; b) E-W direction

The hybrid specimen H1 represents the preferred combination of post-tensioning and energy dissipation and has been used in previous column-to-foundation subassembly testing under uni-directional loading (Palermo et al 2006a,c). It consists of two external dissipators placed at each of the two sides parallel to the plane of the tendons. This configuration was also followed in this research, adding the dissipators to the same column tested with post-tensioning only (Specimen PT). The black line in Figure 6 illustrates the lateral force vs. drift. The tendon force vs. drift is shown in Figure 7(b). Significant hysteretic dissipation is observed due to the presence of the energy dissipators. It is also important to notice that greater dissipation is achieved in the plane perpendicular to the tendons, but it also tends to get some residual displacements because of smaller recentering forces from the tendons in that plane. On the other hand, in the direction parallel to their plane (N-S) full recentering is

achieved due to higher recentering forces from the tendons.

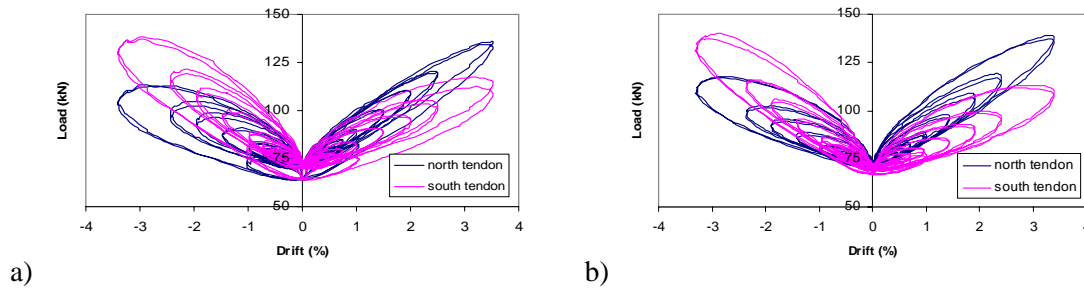

Figure 7: Plots of tendon forces vs. drift a) Specimen PT; b) Specimen H1

To further investigate the recentering and energy dissipation characteristics, hybrid specimens H2 and H3 with different combinations of energy dissipators in terms of number and arrangement were tested. Each of them had a different ratio of recentering vs. dissipation capacity. Specimen H2 (Fig. 5) had two dissipators at each of the four sides, twice as many dissipators in total compared to Specimen H1. The load-displacement plots of Specimen H2 are shown in Figure 8. The two sets of dissipators in orthogonal directions were complementary to each other and resulted in greater energy dissipation but the tendon forces were not adequate for full recentering in such an arrangement. Specimen H3 had two dissipators each at two sides that are perpendicular to the plane of the tendons (Fig. 5). This way the dissipators were further apart along the plane of the tendons compared to Specimen H1, requiring larger recentering forces in the tendons. Figure 9 shows the load-displacement plots. As expected, there are some residual displacements due to insufficient recentering forces from the tendons.

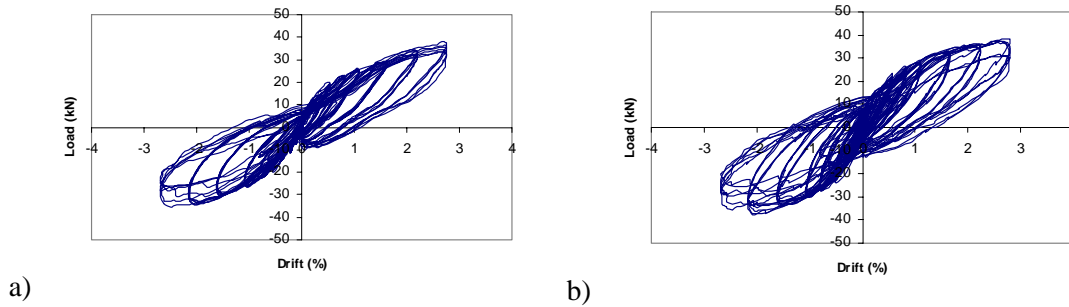

Figure 8: Load-displacement plots of Specimen H2 a) N-S direction; b) E-W direction

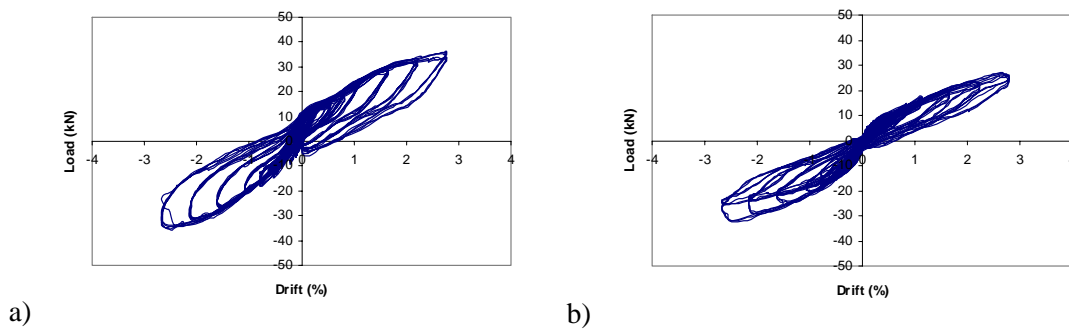

Figure 9: Load-displacement plots of Specimen H3 a) N-S direction; b) E-W direction

As shown in Figure 8, greater energy dissipation can be achieved through the increased number of energy dissipators but in the absence of higher recentering capacity of the arrangement some residual displacements are observed at the end of the loading cycles. In the case of Specimen H3, there is increased energy dissipation compared to Specimen H1 in the direction parallel to the plane of the tendons (N-S) due to larger strains in the dissipators, but the recentering capacity is insufficient for full

recentering. This shows that greater energy dissipation does not necessarily produce the best results and the optimum solution is one with significant energy dissipation and minimum residual displacements.

5 PSEUDO-DYNAMIC TESTS

A series of pseudo-dynamic tests was carried out to simulate slow motion dynamic response of the system when subjected to an earthquake input ground motion, in both post-tensioned-only and hybrid configurations. The effects of different additional dissipation capacity on the dynamic response were investigated and provided valuable information complementary to that obtained from the quasi-static tests.

The details of the earthquake ground motions used in the tests are given in Table 3. As part of the required information to solve the equation of motion of the SDOF system within the pseudo-dynamic algorithm, an equivalent mass of 4500 kg was assumed, corresponding to the expected gravity load (dead load plus a portion of the live load) for the tributary area to a column within a single storey timber building. An equivalent viscous damping of 5% proportional to the initial stiffness was adopted.

Table 3. Characteristics of the adopted earthquake events.

Event	Year	M _w	Station	Duration, sec	Scaling Factor	Component	PGA, g (scaled)
Landers	1992	7.3	Yermo Fire Station	44.0	2.2	360	0.334
						270	0.245
Cape Mendocino	1992	7.1	Fortuna Blvd	44.0	3.8	000	0.441
						090	0.433

The test of the post-tensioned only column could not be continued for the whole duration of Landers accelerogram because the maximum drift exceeded the displacement limit of the testing arrangement. The hybrid system, having additional strength and dissipation capacity provided by the dissipators, was subjected to a 50% higher intensity of the same earthquake record in order to investigate inelastic response and re-centring capability. In spite of the higher intensity of the ground motion, maximum drift was less than the post-tension only case, due to the additional strength and dissipation contribution provided by the external dissipators. The response of the hybrid solution subject to Landers accelerogram is shown in Figure 10. A small residual displacement is observed in the E-W direction due to the smaller out-of-plane recentering capacity of the two prestressing tendons.

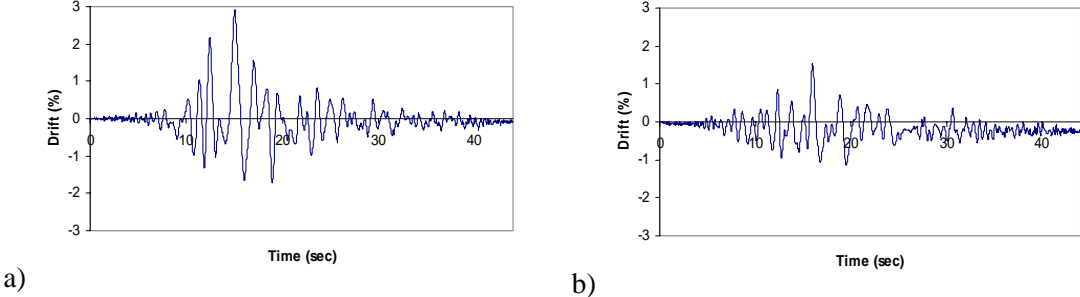

Figure 10: Response of Specimen H2 to Landers accelerogram a) N-S direction; b) E-W direction

The column was tested post-tensioned only under a different accelerogram scaled to have intensity comparable to the Landers earthquake (Table 3). Figure 11 shows the response of the post-tensioned only solution under a recorded Cape Mendocino accelerogram in terms of drift time-history. As expected, the maximum drift in this case is greater than that with the hybrid solution, but full

recentering is achieved despite partial asymmetry of the response.

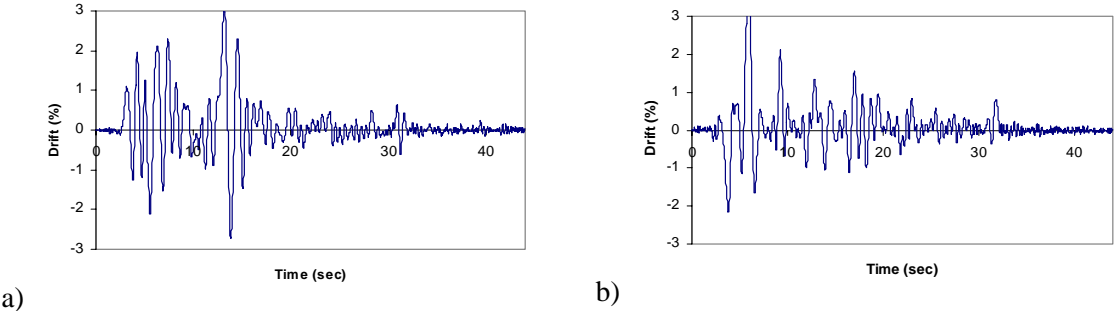

Figure 11: Response of Specimen PT to Cape Mendocino accelerogram a) N-S direction; b) E-W direction

6 FURTHER TESTING OF LVL COLUMN

It was observed after the first series of tests that there was some deterioration of properties of the column. The loading protocol was deemed to be too demanding since any structure was not expected to go through so many cycles of loading at such drifts. Another series of tests with fewer cycles of loading was performed on a new column with identical properties to check for possible degradation of the column properties during the tests. Benchmark tests were undertaken before and after the bi-directional quasi-static tests. The revised loading protocol included one full cloverleaf cycle at each drift in place of three cycles used in previous tests. The initial prestress level was also raised to increase the recentering capacity of the column and thereby eliminate the possibility of residual displacements observed in some of the earlier tests.

Figure 12 and Figure 13 show the comparative load-displacement plots before and after the post-tension only and hybrid biaxial test, respectively. No significant degradation of strength was observed during the biaxial testing of the column. This means that no additional protection is required at the connections in practical applications since the structure is unlikely to experience more than one or two major earthquakes during its lifetime.

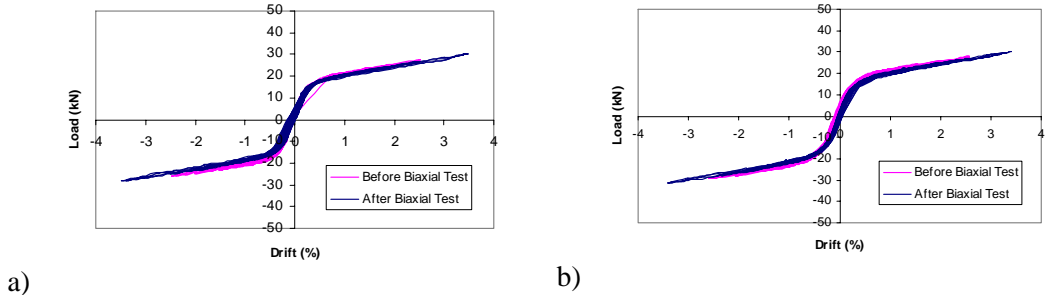

Figure 12: Plots of Specimen PT before and after biaxial test a) N-S direction; b) E-W direction

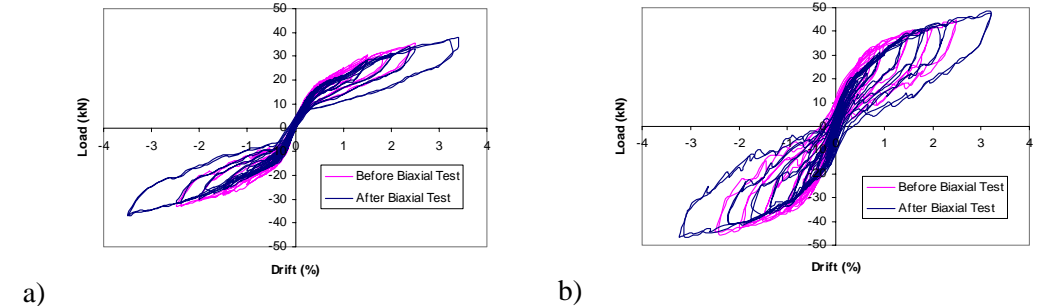

Figure 13: Plots of Specimen H1 before and after biaxial test a) N-S direction; b) E-W direction

7 CONCLUSIONS

The experimental results of cyclic quasi-static and pseudo-dynamic tests on LVL column-to-foundation connections under bi-directional quasi-static cyclic and pseudo-dynamic loading further confirmed the applicability of multi-storey timber buildings with hybrid connections. The hybrid systems showed a significantly greater level of energy dissipation compared with the post-tensioned only solution. In all different simulations of seismic loading, the tested systems exhibited high levels of ductility, negligible residual deformations and no significant damage of the structural elements.

ACKNOWLEDGEMENTS

The research in this paper is financially supported by FIDA (Forest Industries Development Agenda). The LVL was supplied by Carter Holt Harvey. The comments and suggestions from Dr. Alessandro Palermo (Politecnico di Milano, Italy) and Dr. Massimo Fragiaco (University of Sassari, Italy), and technical support from Nigel Dixon and Gavin Keats are gratefully acknowledged.

REFERENCES

- ACI T1.1-01 and ACI T1.1R-01 2001. *Acceptance Criteria for Moment Frames Based on Structural Testing (T1.1-01) and commentary (T1.1R-01)*, ACI Innovation Task group 1 and Collaborators.
- SNZ. 2006. NZS 3101. *Concrete Structures Standard, Appendix B: Special provisions for the seismic design of ductile jointed precast concrete structural systems*, Standards New Zealand, Wellington, New Zealand.
- SNZ. 1993. NZS 3603. *Timber Structures Standard*, Standards New Zealand, Wellington, New Zealand.
- Futurebuild 2003. *Engineered Building Products: Information for Design and Installation*, Carter Holt Harvey Limited, Auckland, New Zealand.
- Palermo A., Pampanin S., Buchanan A., and Newcombe M. 2005. Seismic Design of Multi-storey Buildings using Laminated Veneer Lumber (LVL), *Proc. NZSEE Conference*, Wairakei, New Zealand, CD-ROM.
- Palermo A., Pampanin, S., Fragiaco, M., Buchanan, A. H. and Deam B. L. 2006a. Innovative Seismic Solutions for Multi-storey LVL Timber Buildings, *Proc. of 9th World Conference on Timber Engineering*, Portland, Oregon, CD-ROM.
- Palermo A., Pampanin S., and Buchanan A., 2006b. Experimental Investigations on LVL Seismic Resistant Wall and Frame Subassemblies, *Proc. of First European Conference on Earthquake Engineering and Seismology*, Geneva, Switzerland, CD-ROM.
- Palermo A., Pampanin S., Fragiaco M., Buchanan A. H., Deam B. L. and Pasticier L., 2006c. Quasi-static cyclic tests on seismic-resistant beam-to-column and column-to-foundation subassemblies using Laminated Veneer Lumber (LVL), *Proc. of Australasian Conference on Mechanics and Materials*, Christchurch, New Zealand.
- Priestley, M. J. N., 1991. Overview of the PRESSS Research Program, *PCI Journal*, Vol. 36(4), pp.50-57.
- Priestley, M.J.N., 1996. The PRESSS Program –Current Status and Proposed Plans for Phase III, *PCI Journal*, Vol. 41, No.2, pp.22-40.
- Priestley M.J.N., Sritharan S., Conley J. R. and Pampanin S., 1999. Preliminary Results and Conclusions from the PRESSS Five-story Precast Concrete Test-building, *PCI Journal*, 44(6), 42-67.
- Smith T., Ludwig F., Pampanin S., Fragiaco M., Buchanan A., Deam B., and Palermo A., 2007. Seismic Response of Hybrid-LVL Coupled Walls under Quasi-static and Pseudo-dynamic Testing, *Proc. NZSEE Conference*, Palmerston North, New Zealand, CD-ROM.
- Stanton J.F., Stone W.C., and Cheok G.S., 1997. A Hybrid Reinforced Precast Frame for Seismic Regions, *PCI Journal*, 42(2), 20-32.