

A Random Access Protocol for Unidirectional Bus Networks

RUDOLF MATHAR AND KRZYSZTOF PAWLIKOWSKI

Abstract — A random access protocol for packet-switched, multiple access communication via time slotted busses is investigated. Assuming heavy traffic for all stations, the access probabilities are determined as to allocate a certain portion of the channel capacity to individual stations for achieving prescribed service requirements. In the infinite buffer case with Poisson arrivals the probability generating function of the queue length, and its expectation and variance are determined for a single station. We furthermore calculate the expected delay time of the last arriving packet in a slot, as well as the corresponding variance. Based on these formulas a system of N coupled stations is investigated w.r.t. packet delay and fairness. It turns out that if the bus is able to carry all offered load, then protection of fairness means only deterioration of oneself's performance without improving corresponding parameters for other stations.

I. INTRODUCTION

In a series of papers Mukherjee et al. [3], [4], [5], [6] proposed a medium access protocol for unidirectional high speed networks, called p_i -persistent protocol. It is a direct generalization of the well known p -persistent protocol for omnidirectional busses (cf. [1]), in adapting the probability of a channel access to individual position of stations on the unidirectional bus. A similar technique was already investigated in [2], [7], [8] where transmission priorities are determined in such a way as to achieve optimal system performance for single [2] or multiple [7], [8] unidirectional unfolded busses.

Under the p_i -persistent protocol, time is divided in slots of equal length, each slot able to carry one data packet of fixed size plus some overhead bits necessary for synchronization and control of the network. If station i has a packet to send, it persists with its attempt to transmit the packet in the next free slot with probability p_i (see Fig. 1). The closer a station is located to the origin of the bus the larger is the probability that it encounters a free slot. If, as an extreme case, station 1 has always packets to transmit and its access probability per slot is 1, then there will be no free slots available for subsequent stations. By an appropriate choice of the p_i the access rate to the channel can be balanced between the stations.

This work was partially supported by the Deutsche Forschungsgemeinschaft under Grant Ma 1184/5-1 (R. Mathar), and by the Alexander von Humboldt Foundation (K. Pawlikowski).

Rudolf Mathar is with the Aachen University of Technology, Stochastik, insbesondere Anwendungen in der Informatik, Wuellnerstr. 3, D-52056 Aachen, Germany. This paper was written when he was visiting the Department of Computer Science, University of Canterbury, Christchurch, New Zealand.

Krzysztof Pawlikowski is with the Department of Computer Science, University of Canterbury, Christchurch, New Zealand.

[6] deals with this problem introducing different fairness criteria, e.g., equal mean packet delay, equal blocking, and equal throughput. It is assumed that each station has equal finite buffer capacity M to store packets, arriving at station i according to a Poisson process with intensity λ_i . If an arriving packet encounters a filled buffer it is blocked and lost. Of course, if high blocking rates are tolerated, low delay times are easily achievable, for instance by reducing the buffer size. To compromise these two criteria is the most critical issue of the protocol. The network and the access bridges should be designed in such a way as to cope with the major part of the entire traffic load, which is also stressed in [3].

Pursueing this goal we use a model with infinite buffer size to analyze the behaviour of the random access protocol. Moreover, we look at the network from an operator's point of view, and assume that a certain guaranteed capacity of the network is bought by clients, just enough to satisfy their individual needs. If there is extra unused capacity available, it is offered to all subscribers in order to improve their throughput and delay times. New subscribers receive their ordered capacity, hence possibly reducing the quality of service of others, but never below the guaranteed threshold. A network control of this type can be implemented by dynamically steering the access probabilities p_i , which offers an elegant way of warding off overload.

A surprising point turns out in the case when the bus is able to carry all offered traffic from Poisson arrival streams, or more generally, from arrival processes with independent increments. Then, if station i reduces its access probability p_i in order to be fair, this deteriorates the waiting times at station i , but does not improve waiting times at subsequent stations $i+1, \dots, N$. Hence, fairness can be achieved only by sacrificing a certain part of overall performance.

We set out to describe briefly the topology of the bus which was basically developed in [6]. Empty slots are generated by a control station, and slots drop off the bus at the end (black boxes in Fig. 1). N stations are using the bus for communication, each sensing the outbound and inbound channel. Stations are labeled $1, \dots, N$ according to their relative position on the bus, starting with the station closest to the control station. The packet arrival stream at station i is assumed to be a process with independent increments with mean λ_i (packets per slot), where packets arrive entirely at time instants, e.g. in bulks of 64 bits in parallel. Packets are sequentially copied bit-by-bit to

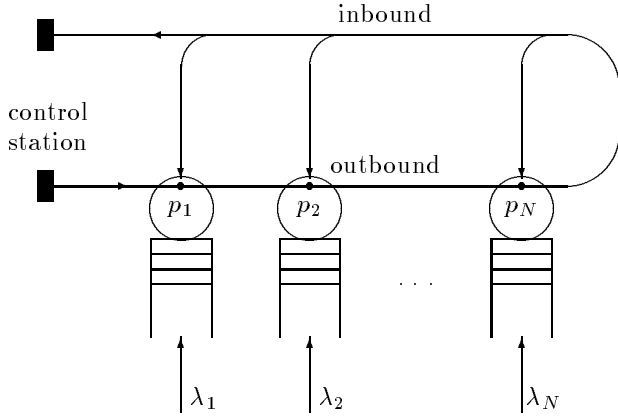

Fig. 1. Topology of the network

the channel. Each station has a large buffer, modelled as a buffer of infinite size, to store packets. If a station has a packet to send, it independently attempts to transmit it in the next slot with probability p_i , provided this slot is empty. With probability $1 - p_i$ it leaves an empty slot passing for use by subsequent stations. We furthermore suppose that the arrival processes at different stations are stochastically independent.

A packet arriving at a random instant τ at a buffer already filled with k packets has to wait a random number of slots until the k packets ahead are cleared, moreover a random number of slots until its own transmission starts, and one slot until it is completely shipped out to the channel, counted from the beginning of the next slot after its arrival time τ . Fig. 2 may help to clarify the principles. Hence, the minimum waiting time for a packet arriving at an empty buffer is 1.

The basic problem now is how to choose the p_i such that the above described requirements apply.

II. ACCESS PROBABILITIES UNDER HEAVY TRAFFIC

If the bus capacity is C bps, then user i may reserve (or buy) a certain portion α_i , $0 < \alpha_i \leq 1$, to satisfy her/his needs. In summary, N users share a certain portion of the channel capacity by choosing (or getting assigned) $\alpha_1, \dots, \alpha_N > 0$, $\sum_{i=1}^N \alpha_i \leq 1$, each demanding for $\lfloor \alpha_i C \rfloor$ bps on the average. To guaranty this portion for each station under heavy traffic the equations

$$(1 - p_1) \cdots (1 - p_{i-1}) p_i = \alpha_i, \quad i = 1, \dots, N, \quad (1)$$

have to be solved. The left hand side gives the probability that a slot is used by station i , if all stations always have packets to transmit. Products with an empty index range are defined as 1, and empty sums correspondingly as 0.

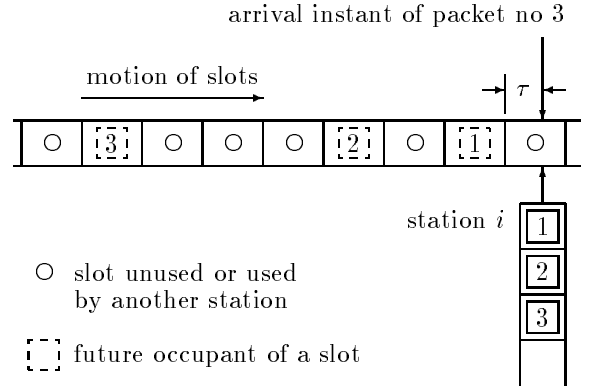

Fig. 2. Example of waiting times. Waiting time for packet no 3 = $(6+1) + \tau$ slots, τ the residual life time of the present slot.

Proposition 1. For given $\alpha_1, \dots, \alpha_N \geq 0$, $\sum_{i=1}^N \alpha_i \leq 1$, the system of equations (1) is solved by

$$p_i = \frac{\alpha_i}{1 - \sum_{j=1}^{i-1} \alpha_j}, \quad i = 1, \dots, N. \quad (2)$$

This is shown by induction. $p_1 = \alpha_1$ is obvious. Assume that (2) holds for all $i \leq k$. Then $1 - p_i = (1 - \sum_{j=1}^i \alpha_j) / (1 - \sum_{j=1}^{i-1} \alpha_j)$ for all $i \leq k$, and

$$\prod_{j=1}^i (1 - p_j) = 1 - \sum_{j=1}^i \alpha_j \quad \text{for all } i \leq k. \quad (3)$$

Hence, by (1)

$$(1 - p_1) \cdots (1 - p_i) p_{i+1} = \left(1 - \sum_{j=1}^i \alpha_j\right) p_{i+1} = \alpha_{i+1},$$

yielding $p_{i+1} = \alpha_{i+1} / (1 - \sum_{j=1}^i \alpha_j)$. \blacksquare

If p_i are chosen according to (2), then from (3) it is clear that the free capacity, i.e., the probability that a slot stays empty having passed through all stations is

$$(1 - p_1) \cdots (1 - p_N) = 1 - \sum_{j=1}^N \alpha_j,$$

as expected. The free capacity can be used for future subscribers, or it can be used to improve the actual station's performance parameters as long as it is not needed. This can be achieved by enlarging the p_i .

In the special case that all stations equally share the entire channel capacity, i.e., $\alpha_i = \frac{1}{N}$ for all i , the access probabilities in (2) become

$$p_i = \frac{1}{N - i + 1}, \quad i = 1, \dots, N,$$

which in case of equal λ_i satisfies the fairness criteria of [6] under heavy traffic assumptions.

III. QUEUE LENGTH AND WAITING TIMES

It is important for each station to know its queue length distribution and the mean waiting times of packets as a function of the actual access probabilities p_i and the traffic loads λ_i . Obviously, the performance parameters of each station are influenced by the traffic load and the presently used p_i of other stations.

We first assume that there is only one station on the bus with channel access probability p and packet arrival times according to a one-dimensional Poisson process with intensity λ . λ is the average number of packets arriving per slot, if one assumes the slot length as the unit of time. The assumption of a Poisson arrival stream can be easily relaxed to processes with independent increments, see, e.g., A1 in [7]. As an approximation to the real system, the results for one station extend to the marginal distribution of an arbitrary number of stations on the same bus, as is shown later on.

We investigate the system in statistical equilibrium, and for this purpose deal with the embedded Markov chain at slot beginning instants. Let X_n denote the number of packets present in the buffer at the beginning time of slot n . Furthermore, let A_n be the number of arriving packets during the pass of slot n , and B_n be independent, Bernoulli distributed random variables, $n \in \mathbb{N}_0$. Let $x^+ = \max\{x, 0\}$ denote the positive part of $x \in \mathbb{R}$. Then

$$X_n = (X_{n-1} - B_{n-1})^+ + A_{n-1}, \quad n \in \mathbb{N}, \quad (4)$$

describes the evolution of the queue length at slot beginning times. Since the arrival process is Poissonian, (4) defines a Markov chain with state space \mathbb{N}_0 . We set out to determine the probability generating function of the stationary distribution of (4), provided it exists. With $q = 1 - p$ the transition matrix of (4) is given by

$$\begin{pmatrix} e^{-\lambda} & \lambda e^{-\lambda} & \frac{\lambda^2}{2!} e^{-\lambda} & \cdots \\ p e^{-\lambda} & q e^{-\lambda} + p \lambda e^{-\lambda} & q \lambda e^{-\lambda} + p \frac{\lambda^2}{2!} e^{-\lambda} & \cdots \\ 0 & p e^{-\lambda} & q e^{-\lambda} + p \lambda e^{-\lambda} & \cdots \\ 0 & 0 & p e^{-\lambda} & \cdots \\ \vdots & \vdots & \vdots & \ddots \end{pmatrix}$$

which is of the form

$$\begin{pmatrix} a_0 & a_1 & a_2 & a_3 & \cdots \\ b_0 & b_1 & b_2 & b_3 & \cdots \\ 0 & b_0 & b_1 & b_2 & \cdots \\ 0 & 0 & b_0 & b_1 & \cdots \\ \vdots & \vdots & \vdots & \vdots & \ddots \end{pmatrix} \quad (5)$$

with

$$a_i = e^{-\lambda} \frac{\lambda^i}{i!}, \quad \text{and} \quad (6)$$

$$b_i = p a_i + q a_{i-1}, \quad i \in \mathbb{N}_0,$$

where $a_{-1} = 0$. The balance equations to determine a stationary distribution $\boldsymbol{\pi} = (\pi_0, \pi_1, \dots)$ read as

$$\pi_n = a_n \pi_0 + \sum_{j=0}^n b_{n-j} \pi_{j+1}, \quad n \in \mathbb{N}_0. \quad (7)$$

Let $A(z)$, $B(z)$, and $G(z)$ denote the generating functions of the distributions (a_0, a_1, \dots) , (b_0, b_1, \dots) in the transition matrix (5), and (π_0, π_1, \dots) , respectively. Multiplying both sides of (7) with z^n and summing over n yields

$$\begin{aligned} G(z) &= \sum_{n=0}^{\infty} \pi_n z^n \\ &= \pi_0 \sum_{n=0}^{\infty} a_n z^n + \frac{1}{z} \sum_{n=0}^{\infty} \left(\sum_{j=0}^n b_{n-j} \pi_{j+1} \right) z^{n+1} \\ &= \pi_0 A(z) + \frac{1}{z} (G(z) B(z) - \pi_0 B(z)). \end{aligned}$$

Solving for $G(z)$ gives

$$G(z) = \frac{\pi_0 (z A(z) - B(z))}{z - B(z)}. \quad (8)$$

From (6) we conclude that

$$\sum_{n=0}^{\infty} b_n z^n = p \sum_{n=0}^{\infty} a_n z^n + (1-p) z \sum_{n=0}^{\infty} a_n z^n,$$

i.e.,

$$B(z) = (p + (1-p)z) A(z).$$

$A(z) = e^{\lambda(z-1)}$ is the generating function of a Poisson distribution, which entails

$$G(z) = \pi_0 \frac{p(z-1)e^{\lambda(z-1)}}{z - (z-p(z-1))e^{\lambda(z-1)}}, \quad z > 0.$$

By Abel's limit theorem π_0 is determined from the fact that $\lim_{z \rightarrow 1} G(z) = 1$. Applying L'Hospital's rule gives $\lim_{z \rightarrow 1} G(z) = \pi_0 p / (p - \lambda)$ such that

$$\pi_0 = \frac{p - \lambda}{p} = 1 - \frac{\lambda}{p}. \quad (9)$$

In summary we get

$$G(z) = \frac{(p - \lambda)(z - 1)e^{\lambda(z-1)}}{z - (z - p(z - 1))e^{\lambda(z-1)}}, \quad z > 0, \quad (10)$$

as the generating function of the queue length distribution of packets in the buffer awaiting transmission in steady state at the beginning of slots. Let X denote a random variable having this distribution.

From (10) it is easily seen that a stationary distribution exists whenever $\lambda < p$, i.e., the average number of packets arriving in a slot is smaller than the average number of packets shipped out to the channel.

$E(X)$

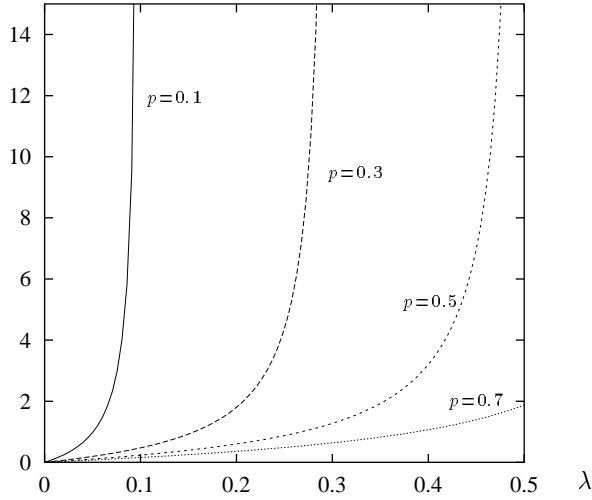

Fig. 3. $E(X)$ as a function of λ

First and second moments of the queue length distribution can be determined from the first and second derivative of G , taking limits as $z \rightarrow 1^-$. After longwinded and tedious algebra, using L'Hospital's rule iteratively, we obtain for $\lambda < p$

$$E(X) = \lim_{z \rightarrow 1^-} G'(z) = \frac{\lambda(2-\lambda)}{2(p-\lambda)}, \quad (11)$$

$$E(X(X-1)) = \lim_{z \rightarrow 1^-} G''(z)$$

$$= \frac{\lambda^2(\lambda^2 + 2\lambda(p-3) - 6(p-2))}{6(p-\lambda)^2}.$$

The corresponding variance

$$V(X) = E(X(X-1)) - E(X)(E(X)-1)$$

$$= \frac{\lambda(12p - 18\lambda p + 2\lambda^2(2p+3) - \lambda^3)}{12(p-\lambda)^2} \quad (12)$$

is directly calculated from the above terms. Fig. 3 and Fig. 4 show the corresponding curves of $E(X)$ and $V(X)$ as a function of λ for $p = 0.1, 0.3, 0.5, 0.7$.

We now deal with the waiting time of a packet arriving in equilibrium. Packets in the buffer waiting for transmission are independently cleared in each slot with probability p . Hence, the number of slots packet j spends at the top of the queue until it is transmitted is a geometrically distributed random variable Z_j , i.e., $P(Z_j = k) = (1-p)^{k-1}p$, $k \in \mathbb{N}$. Because of the memoryless property of the geometric distribution the number of slots passing by until the last packet arriving in slot $n-1$ is cleared is

$$W_n = \sum_{i=1}^{X_n} Z_i,$$

where X_n, Z_1, Z_2, \dots are stochastically independent, and Z_i is geometrically distributed with parameter p .

$V(X)$

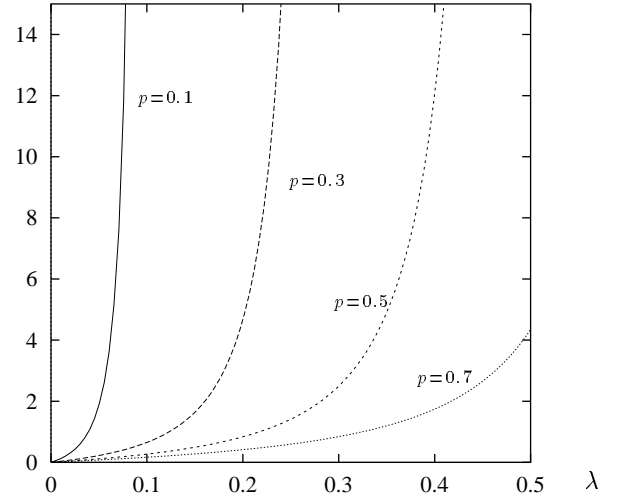

Fig. 4. $V(X)$ as a function of λ

W_n corresponds to the least favourable treatment of a packet arriving in slot $n-1$ in the sense that all other packets arriving in slot $n-1$ have shorter transmission times. Observe that the residual time from the arrival of packets until the beginning of slot n has been neglected. In steady state X_n has the same distribution as X with probability generating function (10).

We now investigate $E(W_n | A_{n-1} > 0)$, the expected waiting time of the last packet arriving in slot $n-1$. The conditional expectation can be partitioned as

$$E(W_n | A_{n-1} > 0)$$

$$= \frac{1}{P(A_{n-1} > 0)} \sum_{k=1}^{\infty} P(A_{n-1} = k) E(W_n | A_{n-1} = k)$$

$$= \frac{1}{1 - e^{-\lambda}} \sum_{k=1}^{\infty} e^{-\lambda} \frac{\lambda^k}{k!} E(W_n | A_{n-1} = k).$$

By Wald's formula it follows that

$$E(W_n | A_{n-1} = k)$$

$$= E\left(\sum_{i=1}^{(X_{n-1} - B_{n-1})^+ + A_{n-1}} Z_i \mid A_{n-1} = k\right)$$

$$= E((X_{n-1} - B_{n-1})^+ + k) E(Z_1)$$

$$= \frac{1}{p}(k + E(X_{n-1} - B_{n-1})^+)$$

$$= \frac{1}{p}(k + E(X_{n-1}) - p(1 - P(X_{n-1} = 0))).$$

Now, restricting our attention to steady state, it follows that the waiting time from the next slot boundary until

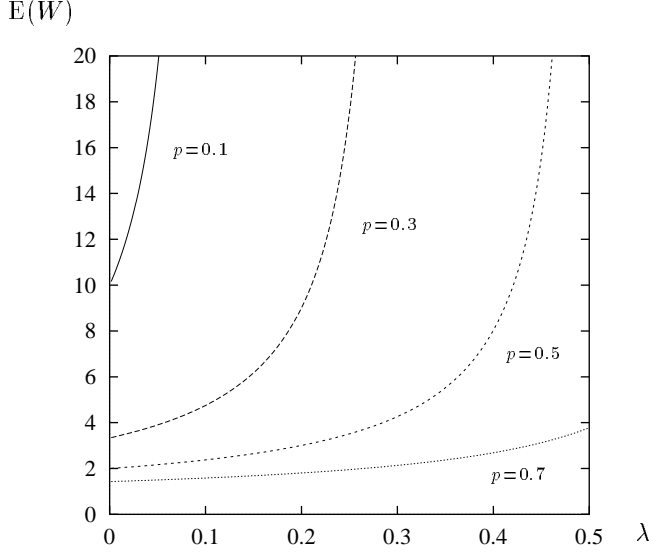

Fig. 5. $E(W)$ as a function of λ

transmission of the last packet arriving in a slot is

$$\begin{aligned} E(W_n | A_{n-1} > 0) &= \frac{e^{-\lambda}}{p(1 - e^{-\lambda})} \sum_{k=1}^{\infty} \frac{\lambda^k}{k!} (k + E(X) - p(1 - \pi_0)) \\ &= \frac{1}{p} \left(E(X) - \lambda + \frac{\lambda}{1 - e^{-\lambda}} \right), \end{aligned}$$

using that $1 - \pi_0 = \lambda/p$. Let W denote the above defined waiting time of the last arriving packet in a slot in equilibrium. From the above we get after some algebra

$$E(W) = \frac{\lambda(e^\lambda(\lambda - 2) + \lambda - 2p + 2)}{2p(\lambda - p)(e^\lambda - 1)} \quad (13)$$

The corresponding curves for $p = 0.1, 0.3, 0.5, 0.7$ are depicted as functions of λ in Fig. 5. It is easy to see that $\lim_{\lambda \rightarrow 0} E(W) = 1/p$ for all $p > 0$.

Applying Wald's formula to second moments yields

$$\begin{aligned} V(W_n | A_{n-1} = k) &= E((X_{n-1} - B_{n-1})^+ + k)V(Z_1) \\ &\quad + V((X_{n-1} - B_{n-1})^+) (E(Z_1))^2. \end{aligned}$$

In steady state $V((X_{n-1} - B_{n-1})^+) = V(X) + 2E(X)(\lambda - p) + \lambda(1 - \lambda)$ holds, and $V(W_n | A_{n-1} > 0)$ is obtained along the same lines as above.

$$\begin{aligned} V(W) &= V(W_n) | A_{n-1} > 0) \\ &= \frac{\lambda}{12p^2(\lambda - p)^2(1 - e^\lambda)} \cdot \\ &\quad \left(e^\lambda(\lambda^3 + 2\lambda^2 p - 6\lambda(p^2 + 2 * p - 2) \right. \\ &\quad \left. + 24p(p - 1)) - \lambda^3 + 2(\lambda^2(5p - 6) \right. \\ &\quad \left. - 3\lambda(3p^2 - 6p + 2) + 6p(p - 2)(p - 1)) \right) \end{aligned} \quad (14)$$

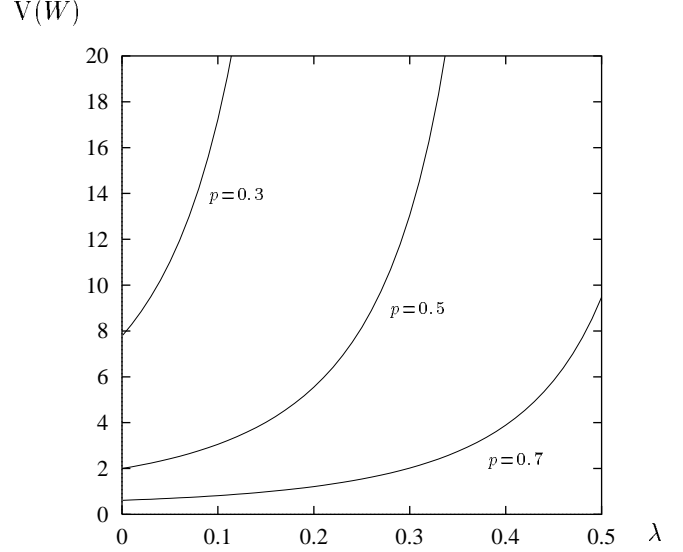

Fig. 6. $V(W)$ as a function of λ

It is easy to see that $\lim_{\lambda \rightarrow 0} V(W) = (1 - p)/p^2$. The corresponding curves are displayed in Fig. 6. Observe that the values for $p = 0.1$ are outside the chosen scale, since in this case $V(W) = 90$ at $\lambda = 0$.

We summarize our results so far in the following

Theorem 1. *If a station has channel access probability p and the arrival process is Poisson with intensity $\lambda < p$, then the generating function of the queue length distribution in steady state at slot boundary points is given by (10) with expectation (11) and variance (12). The expected waiting time of the last arriving packet in a slot is given by (13), and the corresponding variance by (14).*

IV. MULTIPLE ACCESS

The general case of N stations, each persisting to access an empty slot with probability p_i , is now considered. Let q_i denote the probability that the buffer at station i is nonempty at a slot beginning instant in steady state. By (9) it holds for the first station that $q_1 = \lambda_1/p_1$. For station i the probability that a waiting packet is transmitted in a slot can be approximated by

$$p_i^* = (1 - q_1 p_1) \cdots (1 - q_{i-1} p_{i-1}) p_i, \quad i = 1, \dots, N. \quad (15)$$

Hence, with (9)

$$q_i = \frac{\lambda_i}{p_i(1 - q_1 p_1) \cdots (1 - q_{i-1} p_{i-1})}, \quad i = 1, \dots, N.$$

This system can be solved iteratively and yields

$$q_i = \frac{\lambda_i}{p_i(1 - \lambda_1 - \cdots - \lambda_{i-1})}, \quad i = 1, \dots, N,$$

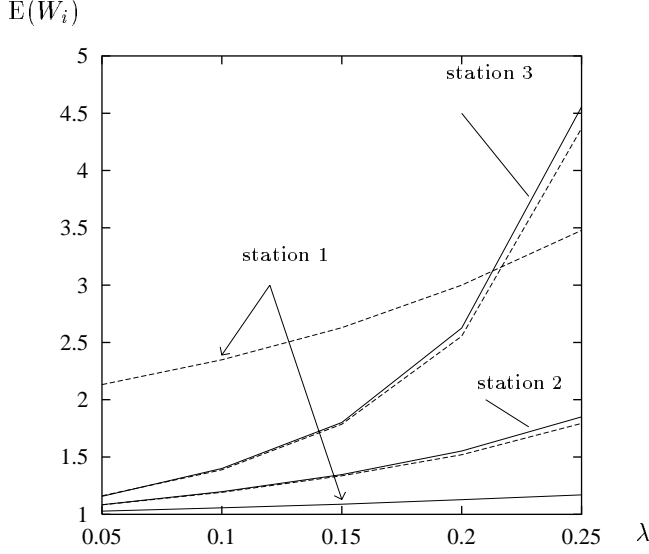

Fig. 7. Simulated mean delay times, $\lambda_i = \lambda$, $p_1 = p_2 = p_3 = 1$ (solid lines) vs. $p_1 = 0.5, p_2 = p_3 = 1$ (dotted lines)

which depends only on the individual p_i , λ_i , and the load of the predecing stations. Observe that $\sum_{i=1}^N \lambda_i < 1$ is necessary for a steady state to exist, which will be assumed further on. Substituting these q_i in (15) yields actual access probabilities

$$p_i^* = (1 - \lambda_1 - \dots - \lambda_{i-1}) p_i. \quad (16)$$

In (4), and also (15) we have assumed sequences of independent Bernoulli variables B_n , each with success probability p . Considering the i -th station in a coupled series of N stations, independence does no longer hold for corresponding Bernoulli variables at station i , if $i \geq 2$. This can be seen by observing the departure process from station 1.

Let $S_n \in \{0, 1\}$, $n \in \mathbb{N}$, denote random variables describing the status of slot n after leaving station 1 in steady state, i.e., $\{S_n = 1\}$, if slot n is occupied by a packet, and $\{S_n = 0\}$, otherwise. Obviously, adapting notation (4)

$$P(S_n = 1) = P(X_n > 0, B_n = 1) = \frac{\lambda}{p} \cdot p = \lambda.$$

On the other hand,

$$\begin{aligned} P(S_n = 1, S_{n+1} = 1) &= P(X_n > 0, B_n = 1, X_{n+1} > 0, B_{n+1} = 1) \\ &= P(X_n > 0, X_n - 1 + A_n > 0, B_{n+1} = 1, B_n = 1) \\ &= p^2 P(X_n > 0, X_n + A_n > 1) \\ &= p^2 (P(X_n > 1)P(A_n = 0) + P(X_n > 0)P(A_n > 0)) \\ &= p^2 (P(X_n > 1)e^{-\lambda} + (\lambda/p)(1 - e^{-\lambda})) \\ &= p^2 ((1 - \pi_0 - \pi_1)e^{-\lambda} + (\lambda/p)(1 - e^{-\lambda})) \\ &= p^2 (\lambda/p - \pi_1 e^{-\lambda}) = e^{-\lambda}(p - \lambda) + \lambda(p + 1) - p, \end{aligned}$$

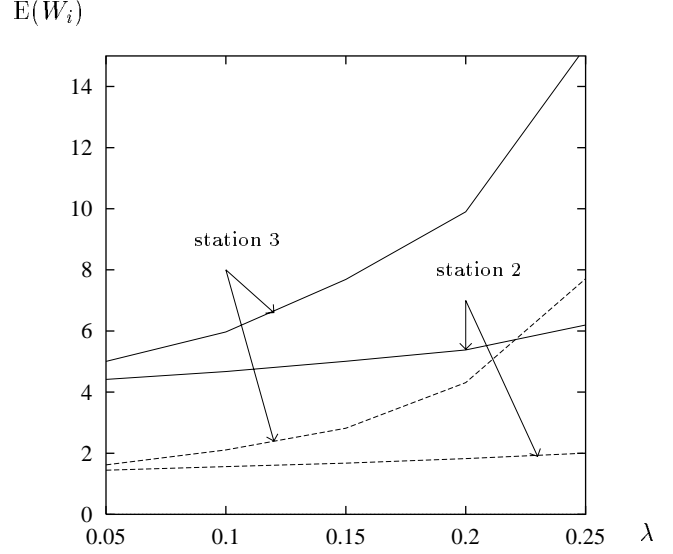

Fig. 8. Simulated mean delay times, bursty traffic at station 1, $\lambda_2 = \lambda_3 = \lambda$, $p_1 = p_2 = p_3 = 1$ (solid lines) vs. $p_1 = 0.5, p_2 = p_3 = 1$ (dotted lines)

using that $\pi_1 = P(X_n = 1) = G'(0) = (p - \lambda)(e^\lambda - 1)/p^2$. Thus, $P(S_n = 1, S_{n+1} = 1) \neq \lambda^2$ for all $0 < \lambda < p$, which shows that the departure stream from station one is not a Bernoulli process with independent S_n . However, in the following we assume independence as in (15), thus a Markovian behaviour for each station. Subsequent results may be taken as an approximation to the performance of the real system. For low and moderate loads the deviation is rather small, as accompanying simulations show.

Let X_i denote the queue length and W_i the waiting time of an arriving packet at station i in steady state. The performance parameters of station i can be calculated from (11), (12), and (13), (14), substituting X by X_i , W by W_i , λ by λ_i , and p by p_i^* , respectively.

With respect to this, (16) is an interesting result. It states:

Proposition 2. *If the bus is able to carry the total traffic, and if arrivals are homogeneous according to Poisson processes, then the performance parameters of station i depend via the access probability p_i^* only on the individually chosen p_i and the load of all preceding stations.*

Thus, if station i increases or decreases its p_i , this influences its own queue length and delay times, but not the corresponding parameters of other stations. Hence, being 'fair' by reducing p_i means to deteriorate the own performance parameters without improving the corresponding ones for other stations. In other words, if the bus is able to cope with all the traffic, and if arrivals are homogeneous (non-bursty) according to a Poisson process, then the p_i -persistent protocol is always 'unfair'; former positions on the bus are more advantageous in yielding better p_i^* , and the performance of subsequent stations cannot be improved by decreasing the p_i of predecessors.

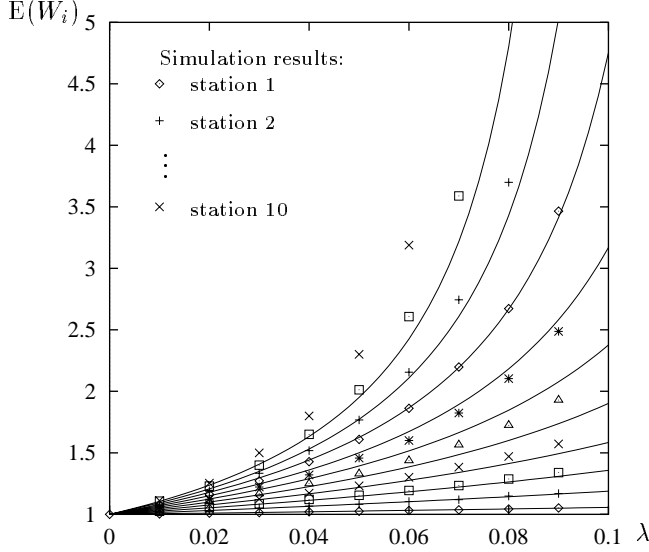

Fig. 9. Mean delay times for $\lambda_i = \lambda \in [0, 0.1]$

This assertion is clearly supported by the simulation results in Fig. 7. Solid lines depict the average waiting times of three stations with $p_1 = p_2 = p_3 = 1$ and $\lambda_1 = \lambda_2 = \lambda_3 \in [0.05, 0.25]$. Dotted lines represent average waiting times for $p_1 = 0.5$ and $p_2 = p_3 = 1$. Obviously, the average waiting time increases dramatically for station 1 with $p_1 = 0.5$, but remains nearly the same for either successor station 2 and 3. Of course, this feature can change under heavy traffic or if steady state is left by the system. Fig. 8 shows the average simulated waiting times at three stations with $p_1 = p_2 = p_3 = 1$ (solid lines) versus $p_1 = 0.5, p_2 = p_3 = 1$ (dotted lines). Arrival processes at station 2 and 3 are Poissonian with intensity λ . Arrivals at station 1 are of the following type. Interarrival times are geometrically distributed with parameter 0.01, and packets arrive in bulks of fixed size 20. The average waiting time of station 1 is approximately 22.4, if $p_1 = 1$, and 53.0, if $p_1 = 0.5$, independent of λ and outside the range of the y -axis scale. Obviously, by decreasing p_1 the waiting times of successors are considerably improved.

To estimate the performance of the protocol, the expected waiting times from (13) and (16) are investigated for $N = 10$ stations. $p_i = 1$ is chosen for all i , according to the above arguments. Waiting times could be deteriorated to those of the last station on the bus by decreasing p_i . In Fig. 9 all arrival rates $\lambda_i = \lambda$ are equal and the corresponding expected waiting times are depicted as a function of $\lambda \in [0, 0.1]$. The lower curve refers to station 1, the upper one to station 10. The same network has been simulated for $\lambda = 0.01, 0.02, \dots, 0.09$ using the AKAROA system [9], and these results are with the relative precision below 0.05, at 0.95 confidence level. The obtained average waiting times are also depicted in Fig. 9, and show a quite satisfying coincidence with the analytical results. However, because of the independence assumption in our model, the analytical values seem to underestimate the

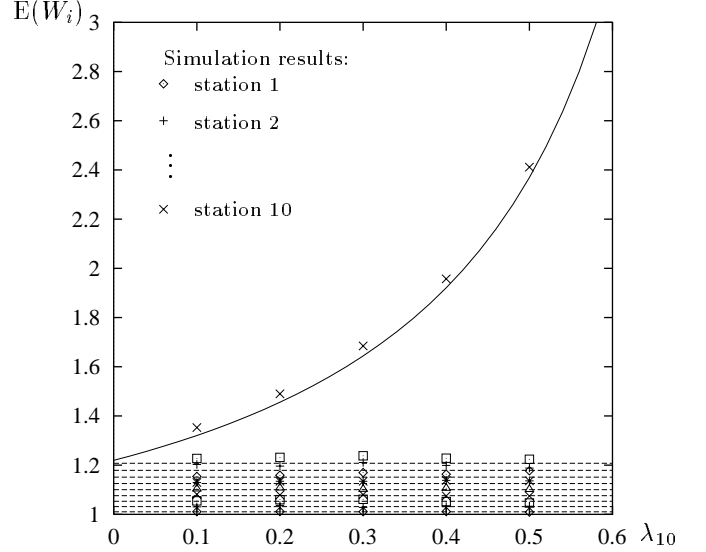

Fig. 10. Mean delay times, $\lambda_i = 0.02, 1 \leq i \leq 9, \lambda_{10} \in [0, 0.6]$

true expected waiting times slightly. This becomes more significant for larger values of λ .

Fig. 10 shows the expected waiting times, when $\lambda_1 = \dots = \lambda_9 = 0.02$ as a function of $\lambda_{10} \in [0, 0.6]$. Of course, in this case the waiting times at stations 1–9 are independent of λ_{10} (dotted lines). Fig. 11 represents the expected waiting times as a function of $\lambda_1 \in [0, 0.6]$ when $\lambda_2 = \dots = \lambda_{10} = 0.02$ are fixed. Obviously, increasing the load of the first station (the corresponding delay is represented by the solid curve) deteriorates uniformly the waiting times at subsequent stations (dotted curves from bottom to top). Both figures show also simulated average waiting times for each station. Again, under the approximate model a slight underestimation can be observed.

Each station has always packets to send if $\lambda_i = \alpha_i$ and $p_i^* = \alpha_i$ for all i . Actually, in this case no proper stationary distribution exists. Solving (16) for p_i gives $p_i = \alpha_i / (1 - \sum_{j=1}^{i-1} \alpha_j)$. As a limiting case we thus obtain the result of Proposition 1.

Certain fairness criteria (cf. [6]) can be satisfied on the basis of the above formulas. All actual access probabilities p_i^* are equal to p_1 , if

$$p_i = \frac{p_1}{1 - \lambda_1 - \dots - \lambda_{i-1}}, \quad i = 1, \dots, N.$$

On the other hand, by (11) expected queue lengths are equal to c , say, if

$$\lambda_i(2 - \lambda_i) = 2c(p_i^* - \lambda_i)$$

for all i , or equivalently,

$$p_i^* = \frac{\lambda_i}{c}(c + 1 - \lambda_i/2), \quad i = 1, \dots, N.$$

There exists a solution only if $\lambda_i \leq 2(1 + c)$ for all i . Corresponding probabilities p_i can be easily calculated from

(16) by dividing the above p_i^* by $(1 - \lambda_1 - \dots - \lambda_{i-1})$, whenever they exist.

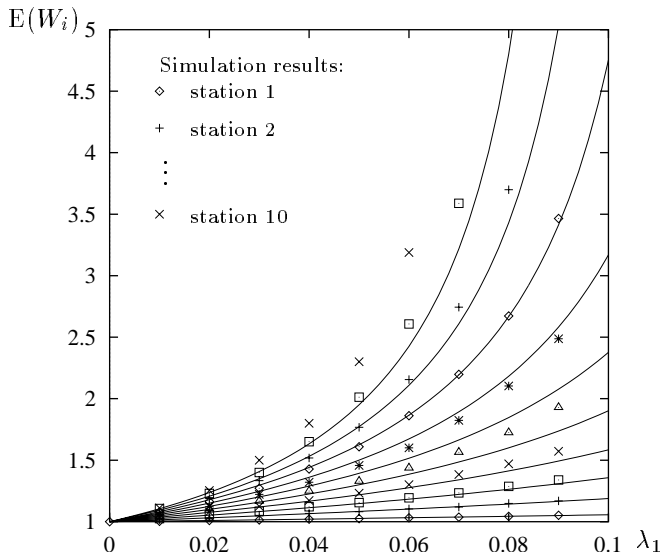

Fig. 11. Mean delay times, $\lambda_1 \in [0, 0.6]$, $\lambda_i = 0.02, i \geq 2$

REFERENCES

- [1] J.L. Hammond and P.J.P. O'Reilly. *Performance Analysis of Local Computer Networks*. Addison-Wesley, Reading, Ma, 1986.
- [2] S. Katz and A.G. Konheim. Priority disciplines in a loop system. *Journal ACM*, 21:340–349, 1974.
- [3] B. Mukherjee. Algorithm for the p_i -persistent protocol for high-speed fibre optic networks. *Computer Communications*, 13(7):387–395, Sept. 1990.
- [4] B. Mukherjee, A.C. Lantz, N.S. Matloff, and S. Banerjee. Dynamic control and accuracy of the p_i -persistent protocol using channel feedback. *IEEE Transactions on Communications*, 39(6):887–897, June 1991.
- [5] B. Mukherjee and J.S. Meditch. Integrating voice with the p_i -persistent protocol for unidirectional broadcast bus networks. *IEEE Transactions on Communications*, 36(12):1287–1295, Dec. 1988.
- [6] B. Mukherjee and J.S. Meditch. The p_i -persistent protocol for unidirectional broadcast bus networks. *IEEE Transactions on Communications*, 36(12):1277–1286, Dec. 1988.
- [7] K. Pawlikowski. Channel occupation in a computer communication system with access on the way. *Bulletin de l'Academie Polonaise des Science*, XXVII(3):33–41, 1979.
- [8] K. Pawlikowski. Multiple channel occupation period in a packet switching system. In *Proceedings ITC'10, Toronto*, pages 4.4a.7.1–5, 1984.
- [9] K. Pawlikowski, V.W.C. Yau, and D. McNickle. Distributed stochastic discrete-event simulation in parallel time streams. In *Proceedings 1994 Winter Simulation Conference*, pages 723–739, Orlando, 1994.