

**Performance and cost evaluation to inform the design and implementation  
of Organic Rankine Cycles in New Zealand**

(Master Thesis)

---

A thesis submitted in partial fulfilment of the requirements for the Degree of  
Master of Engineering in Mechanical Engineering

University of Canterbury

2015

Michael Southon

---

## Abstract

The aim of this thesis is to evaluate ORC systems and technologies from an energy and economic perspective. ORC systems are a growing renewable electricity generation technology, but New Zealand has limited local skills and expertise for identifying ORC resource opportunities and subsequently developing suitable technologies at low cost. For this reason, this thesis researches ORC technology, resource types, and international development, with the aim to determine guidelines for how to cost-effectively develop ORC systems, and to make recommendations applicable to furthering their development within a New Zealand context.

This thesis first uses two surveys, one of commercial ORC installations, and a second of economic evaluations of ORC systems in literature, to determine what resources and economic scenarios are supportive of commercial development. It is found that geothermal resources provide the largest share of ORC capacity, with biomass and waste-heat recovery (WHR) being developed more recently. The surveys also found that countries with high electricity prices or policy interventions have developed a wider range of resources using ORC systems.

This thesis then undertakes an EROI evaluation of ORC electricity generation systems using a combination of top-down and process-based methodologies. Various heat sources; geothermal, biomass, solar, and waste heat are evaluated in order to determine how the utilised resource can affect energy profitability. A wide range of  $EROI_{\text{std}}$  values, from 3.4 – 22.7 are found, with solar resources offering the lowest EROIs, and geothermal systems the highest. Higher still EROI values are found to be obtainable with longer system lifetimes, especially for WHR systems.

Specific engineering aspects of ORC design and technology such as high-side pressure, heat storage, modularity, superheating, pinch-point temperature difference, and turbine efficiency are evaluated in terms of economic performance, and a variety of general conclusions are made about each. It is found that total-system thermo-economic optimisation may not lead to the highest possible EROI, depending on the objective function.

Lastly, the effects of past and potential future changes to the markets and economies surrounding ORCs are explored, including the New Zealand electricity spot price, steel and aluminium prices, subsidies, and climate policy. Of the subsidy types explored, it is found that directly subsidising ORC system capital has the greatest effect on the economic performance of ORC systems, as measured by common metrics.

In conclusion, this thesis finds that ORC systems have a limited applicability to New Zealand's electricity market under current economic conditions outside of geothermal and off-grid generation, but changes to these conditions could potentially make their development more viable. The author recommends that favourable resources should be developed using systems that provide high efficiencies, beyond what might provide the best economic performance, in order to increase EROI, and reduce the future need for costly investments into increasingly less favourable resources.

# Contents

---

<b>Acknowledgements</b> .....	<b>vii</b>
<b>Motivation</b> .....	<b>viii</b>
<b>Approach</b> .....	<b>ix</b>
<b>Chapter 1. Current ORC market and technology status</b> .....	<b>1</b>
<b>1.1 Introduction to ORCs</b> .....	<b>1</b>
<b>1.2 ORC Resources and applications</b> .....	<b>3</b>
1.2.3 Waste heat recovery.....	5
1.2.4. Solar thermal and concentrating solar .....	5
1.2.5 Ocean thermal .....	5
<b>1.3 Introduction to ORC economics</b> .....	<b>6</b>
1.3.1. ORCs in the economy .....	6
1.3.2. Standard investment evaluation criteria .....	8
1.3.3. Costs and revenues .....	10
<b>1.4 Current and potential scale of ORC development</b> .....	<b>13</b>
1.4.1 Past development.....	13
1.4.2. Development potential of ORC resources .....	17
1.4.3. ORC capacity at current growth rates .....	22
<b>1.5 Survey of economic analyses on ORCs</b> .....	<b>24</b>
1.5.1. ORC price index .....	24
1.5.2. Survey results .....	26
1.5.3 ORC systems in New Zealand under future electricity demand and energy prices .....	28
<b>1.6 Competing technologies</b> .....	<b>30</b>
1.6.1. Geothermal competing technologies.....	30
1.6.2. Biomass competing technologies.....	30
1.6.3. Waste heat recovery competing technologies.....	33
1.6.4. Solar competing technologies .....	33
<b>Chapter 2. Energy Return on Investment (EROI) of ORC systems</b> .....	<b>34</b>
<b>2.1 Introduction to EROI</b> .....	<b>34</b>
<b>2.2 Methodology</b> .....	<b>37</b>
2.2.1 Development of methodology.....	37
2.2.2 Study Procedure.....	39
2.2.3 Specific energy of ORC systems - Waikite Valley UTC PureCycle base case .....	41
2.2.4. EROI of Waikite ORC power plant .....	44
<b>2.3 Application of EROI method to other ORC systems</b> .....	<b>46</b>
2.3.1. Methodology .....	46
2.3.2. 410 kW Chena hot springs geothermal system .....	47
2.3.3. SKM NZ geothermal study .....	49

2.3.4. Biomass addition to existing boiler (CHP).....	50
2.3.5 Biomass power-only system .....	52
2.3.6. Solar thermal ORC system.....	54
2.3.7. Waste heat ORC system.....	55
<b>2.4 Analysis of results .....</b>	<b>56</b>
2.4.1. Results summary.....	56
2.4.2 Comparison of EROIs for ORC systems.....	57
2.4.3. Comparison of ORCs with other technologies .....	60
<b>2.5 Conclusions from EROI study.....</b>	<b>62</b>
<b>Chapter 3 – Economic ORC cycle design .....</b>	<b>63</b>
<b>3.1 Cost estimation of ORC technologies .....</b>	<b>63</b>
3.1.1. Core component costs .....	64
3.1.3. Resource-specific equipment costs.....	66
3.1.4. Annual maintenance costs.....	67
3.1.5. Annual Operating costs.....	68
<b>3.2. High-side and low-side pressure.....</b>	<b>69</b>
3.2.1. Turbines in high-pressure cycles .....	69
3.2.2. Biomass boiler pressure .....	70
3.2.3. Evaporators in high-pressure cycles .....	72
3.2.4. Superheating and subcooling.....	72
3.2.5. Economic study of a CO <sub>2</sub> high-pressre cycle.....	72
<b>3.3. Variable operating condition (off-design) economics.....</b>	<b>77</b>
3.3.1 Variable heat source and storage.....	77
3.3.2. Steel mill example – KOBM hood.....	78
3.3.3. Non-Condensable Gas (NCG) build-up .....	80
3.3.4. Modularity .....	81
<b>3.4 ORC component economics.....</b>	<b>84</b>
3.4.1. Expander .....	85
3.4.2. Heat exchanger pinch point.....	858
3.4.3. Regenerator.....	93
<b>3.5 ORC optimisation methodologies.....</b>	<b>97</b>
3.5.1 Thermo-economic evaluations in literature.....	97
3.5.2 Value of thermo-economic evaluation meta-analysis.....	99
<b>Chapter 4 – Implementation of ORCs into the wider economy .....</b>	<b>101</b>
<b>4.1 Electricity Price and seasonal performance .....</b>	<b>101</b>
4.1.1 Analysis setup .....	102
4.1.2. Daily price variation .....	103
4.1.3. Monthly price variation.....	104
4.1.5. Economic capacity factor.....	106

<b>4.2 ORC cost sensitivity to material prices .....</b>	<b>107</b>
4.2.1 Metal weight in ORC systems.....	11307
4.3.2 Metal price variation .....	11309
4.3.3 Price index correlation .....	1130
<b>4.3 Discount rates and subsidies.....</b>	<b>111</b>
4.3.1. Effect of discount rates on investment outlook .....	111
4.3.2 Social and company discount rates.....	113
4.3.3. Subsidy level required to achieve social discount rates.....	114
<b>4.4 GHG pricing and ORCs .....</b>	<b>116</b>
4.4.1 CO <sub>2</sub> emissions from ORC electricity .....	116
4.4.2 Current regulatory environment in New Zealand.....	118
<b>Conclusions and Outlook .....</b>	<b>121</b>
<b>Bibliography: Motivation Statement .....</b>	<b>123</b>
<b>Bibliography: Chapter 1 .....</b>	<b>123</b>
<b>Bibliography: Chapter 2 .....</b>	<b>123</b>
<b>Bibliography: Chapter 3 .....</b>	<b>123</b>
<b>Bibliography: Chapter 4 .....</b>	<b>123</b>
<b>Appendix A1 .....</b>	<b>135</b>
<b>Appendix A2 .....</b>	<b>140</b>
<b>Appendix A3 .....</b>	<b>141</b>
<b>Appendix A4 .....</b>	<b>145</b>

## List of Figures

1.1 Schematic and T-s diagram representations of a simple Rankine cycle.....	1
1.2 Common ORC resources .....	3
1.3 Proposed ORC applications.....	3
1.4 Direct economic and physical inputs and outputs of an ORC system.....	6
1.5 Estimated specific cost of geothermal construction .....	11
1.6 Average New Zealand electricity price .....	12
1.7 Market evolution of ORC systems by resource type.....	14
1.8 Growth in overall ORC generation capacity .....	15
1.9 Growth in NZ generation capacity .....	16
1.10 Resource-specific linear growth trends for ORC systems.....	22
1.11 Estimated ORC (US) price index vs. US total PPI.....	25
1.12 Box-and-whisker plot of levelised electricity cost.....	26
1.13 Box-and-whisker plot of the Electricity sale price .....	27
1.14 The maximum capital cost of an (ORC) power generation system in NZ.....	29
1.15 Capacity growth of biomass ORC and biomass Gasification systems .....	32

2.1 Oil production costs from various sources as a function of the EROI.....	35
2.2 EROI for significant conventional and emerging energy systems.....	36
2.3 Diagram of the Energy-Economy system as defined for the analysis.....	36
2.4 Model of energy - economy system indicating system boundaries.....	37
2.5 Distribution of embodied energy and energy usage for Waikite.....	45
2.6 Range of dynamic EROI values for ORC systems operating from various resources.....	57
2.7 Breakdown of energy input fraction for ORC systems operating from various resources.....	58
2.8 Selected dynamic EROI curves for biomass and WHR resources.....	59
2.9 EROI of various electricity sources vs. global usage.....	60
3.1 Estimates for the additional cost of easy and hard plant installations.....	65
3.2 Annual maintenance cost as a percentage of core equipment capital cost.....	67
3.3 Variation in fluid temperatures during the heat addition process.....	72
3.4 Example temperature profile of steel plant KOBM hood.....	78
3.5 Purchase cost estimates of shell and tube heat exchangers.....	82
3.6 Maximum cost of an investment into a higher efficiency turbine.....	86
3.7 Maximum cost of an investment into a 10% higher efficiency turbine.....	87
3.8 Minimum percentage reduction in price for a turbine with 10% lower efficiency.....	87
3.9 T-s diagram of a standard ORC cycle indicating the PPTD.....	88
3.10 Contour plot showing region of minimum specific investment cost.....	90
3.11 Pressure ratio vs. evaporator PPTD of ORC system.....	91
3.12 Schematic representation of an ORC with regenerator.....	93
3.13 The SIC, NPV/kW, and DPP for an investment into regenerator.....	95
3.14 Specific investment cost and net power output vs. evaporation temperature.....	97
3.15 NPV of thermo-economic and thermodynamic optimum systems.....	100
4.1 Average hourly temperature, power production, and final electricity price.....	103
4.2 Average monthly temperature, power production, and final electricity price - evaporative.....	104
4.3 Average monthly temperature, power production, and final electricity - lake water.....	104
4.4 Real price indices for metals, crude oil and US HVAC equipment.....	109
4.5 Correlation coefficient for crude oil and metals, HVAC/R and crude oil, and HVAC/R.....	110
4.6 Contour plot showing the discounted payback period for an investment 5% discount.....	111
4.7 Contour plot showing the discounted payback period for an investment 2% discount.....	112
A2.1 Cost of geothermal well drilling.....	140
A4.1 Countries with carbon tax or ETS carbon pricing mechanisms.....	146

## List of Tables

1.1	Advantages and disadvantages of ORC cycles compared to steam Rankine cycles .....	2
1.2	Common investment evaluation criteria used in this thesis. ....	8
1.3	Major ORC manufacturers and the total production capacity of their units .....	13
1.4	Percentage generation capacity and average unit size from survey. ....	14
1.5	Current annual electricity production from renewable resources by ORC machines .....	20
1.6	Proportion of current electricity generation provided by ORCs .....	21
1.7	Years in which ORC systems will reach estimated potential resource limits .....	22
1.8	Average economic results for each heat resource .....	26
1.9	Estimated worldwide production capacity of biomass-electricity conversion technologies..	30
2.1	Capital budget and estimated embodied energy for the proposed Waikite plant .....	42
2.2	Expected annual operating costs for Waikite 272kW Binary power plant .....	43
2.3	Calculated EROI <sub>std</sub> and EROI <sub>3,i</sub> for the Waikite hot springs geothermal plant .....	45
2.4	Summary of embodied energy costs of Waikite (NZ) and Chena (Alaska) ORCs by use ....	48
2.5	Energy intensity of well drilling in the EIO/LCA model. ....	49
2.6	Summary of EROI for large binary projects in New Zealand.....	49
2.7	Summary of EROI for the electrical component of 1MWe Biomass CHP project .....	51
2.8	Summary of EROI for the 1.33MWe Biomass power-only electricity project.....	52
2.9	Energy costs per kWe and EROI for theoretical solar electricity and solar CHP systems....	55
2.10	Energy costs per kWe capacity and EROI for theoretical WHR ORC system. ....	55
2.11	Estimated lifetime EROI of electricity generation from various ORC resources .....	56
3.1	Minimum turbine material requirements to meet ISO standard 14661:2000(E).....	69
3.2	Summary of range of operating conditions for shell type boilers. ....	70
3.3	Estimated operation cost for several worst and best case scenarios. ....	70
3.4	Maximum pressures of common types of plate heat exchanger.....	73
3.5	Summary of cycles using CO <sub>2</sub> and R123 at maximum power output .....	75
3.6	Approximate calculation for thermal energy that must be stored.....	78
3.7	Advantages and disadvantages of developing small, modular units .....	81
3.8	Summary of system design flow-on effects from decreases to the PPTD.....	92
3.9	SIC, efficiency and output power from Quoilin et. al .....	99
4.1	Summary of daily and seasonal return correction factors.....	105
4.2	Material weights per kW for a 10 MW binary plant system.....	107
4.3	Estimates for plant-only material weights .....	108
4.4	Investment metrics under various economic interventions or two plants.....	114
4.5	Estimated lifetime gCO <sub>2</sub> e/kWh of ORC resources .....	117

A1.1	Current and potential forest usage for biomass .....	135
A1.2 Pt.1	Technology types and surrounding economic environment of ORC systems .....	136
A1.2 Pt.2	Economic performance of ORC systems in analyses surveyed .....	138
A1.3	US-based ORC price index, as formulated in Section 1.5.1.....	139
A2.1	Calculation procedure to determine average energy input/energy output of forestry....	140
A3.1	Price estimate formulas for common ORC components .....	141
A3.2	Illustrative list of material factors for shell and tube heat exchangers.....	142
A3.3	Material factors for pumps.....	142
A3.4	Criteria for supervision and maintenance of boilers in NZ .....	143
A3.5	Assumed U-values for heat exchanger models .....	144
A4.1	Seasonal adjustment factors to calculate the annual return of ORC.....	145
A4.2	Main components of the ORC-C system, their weight and main materials .....	145
A4.3	Estimated economic parameters for new Coal and Binary power generation. ....	145
A4.4	Estimated CO <sub>2</sub> -e emissions in g/kWh of electricity produced by various sources .....	147



# Acknowledgements

I would like to acknowledge my supervisor, Prof. Susan Krumdieck, for her extensive guidance and clear thinking that inspired much of this thesis.

I would also like to acknowledge my fellow students participating in the Above Ground Geothermal and Allied Technologies (AGGAT) programme who contributed in various ways to the thinking and experimentation behind this thesis and my other master's study.

This work was supported by the New Zealand Heavy Engineering Research Association (HERA) funded by the Ministry for Science & Innovation.

"Let nature deal with the matter, which is her own, as she pleases; let us be cheerful and brave in the face of everything, reflecting that it is nothing of our own that perishes"

- Seneca, On Providence v. 7-9

# Motivation

The steam-Rankine cycle is a process that converts heat energy into electricity, producing 65% of electricity production worldwide (IEA, 2014). The Organic Rankine Cycle (ORC) provides a way to produce electricity from heat resources that are at too low of a temperature to be competitively converted using steam-Rankine cycles. There is growing international interest in ORC technology due to its ability to utilise non-fossil fuel sources, to mitigate peak loads or provide base load (always-on) electricity, and its economic viability in markets with high electricity prices or state subsidies for renewable technologies.

Current commercial Organic Rankine Cycles designs are held by a few companies worldwide, which maintain a tight hold over their technology (Quoilin, Declaye, Tchanche, & Lemort, 2011). New Zealand clients of ORC technology providers are supplied with minimal knowledge of the systems that they have installed, and propose that the economics of ORC solutions could be improved by a local competitor. On top of this, New Zealand still has significant remaining opportunities to utilise its low enthalpy resources for electricity and heating (Felicito M, 2011). If these opportunities were to be met locally, it would help in establishing a base of expertise for ORC resource prospecting, design, and manufacturing within New Zealand, which can then be exported throughout the world.

The Above Ground Geothermal Allied Technologies (AGGAT) research proposal aims to develop the expertise required to produce small Organic Rankine Cycle (ORC) units, to create electricity from low temperature heat sources (HERA, 2012). The AGGAT research proposal is sponsored by the Heavy Engineering and Research Organisation (HERA), a non-profit industry-governed research association that aims to link market needs with scientific research in New Zealand (HERA, 2013). The ability for the aims of the AGGAT proposal to be carried into the future largely rest on the economic feasibility of Organic Rankine Cycle electricity production in New Zealand.

A clear understanding of the opportunities presented by ORC technologies, their potential, and their costs is required to help point the way for ORC development. This thesis aims to provide a thorough energy and economic evaluation of low enthalpy power generation technologies to help inform their adoption into New Zealand. The analysis in this thesis also provides insight into the effect that ORC systems may have on national and societal wealth, and where opportunities lie for policymakers and business.

# Approach

A highly lateral approach is taken in this thesis, in order to provide as much of an understanding as possible of the value of ORC technologies, their potential for improvements, and how their development could best be facilitated under domestic, international, and future economies. The body of investigation presented in this master's thesis aims to provide a knowledge base with which to guide the advancement of ORCs, as well as renewable electricity technologies in general.

In Chapter 1, the current market and technology status for ORC are outlined with consideration for the maturity of the technology and potential future developments. In Chapter 2, the impact of the implementation of renewable technologies, and specifically ORCs, is defined through the measure of energy return on investment (EROI). In Chapter 3, currently employed ORC technologies are evaluated in terms of design and economic performance, and in Chapter 4, a wider system view is taken to determine the future potential of ORC systems under various economic scenarios.

# 1. Current ORC market and technology status

## 1.1 Introduction to ORCs

The Rankine cycle is a closed thermodynamic cycle that uses a heat source to extract a work output. The basic Rankine cycle works by passing a fluid through four main processes;

- Compression – Achieved by adding work energy to the fluid, commonly by using a pump or gravity head.
- Evaporation – Achieved by adding heat energy to the fluid, usually through transfer from via one or multiple heat exchangers.
- Expansion – Work energy is extracted from the pressurised fluid to create power. This is usually achieved through the use of an ‘expansion machine’ such as a turbine or scroll expander.
- Condensation – Heat energy is removed from the fluid to return it to a state suitable for compression using a heat exchanger and a cooling fluid.

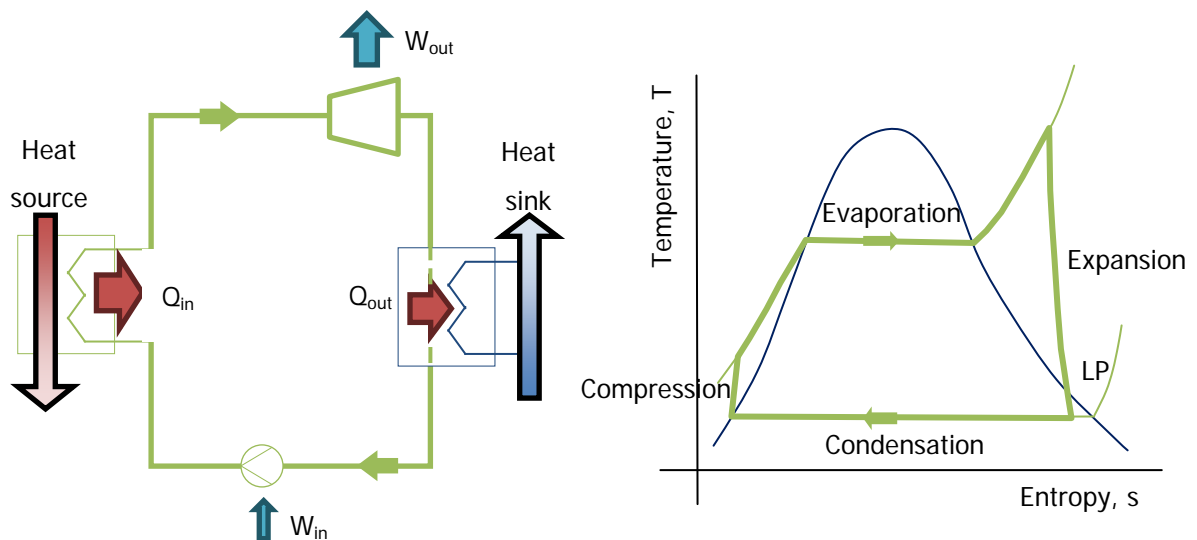

**Figure 1.1: Schematic and T-s diagram representations of a simple Rankine cycle**

The Rankine cycle with steam as a working fluid is used to produce 65% of electricity generation worldwide (IEA, 2014). The Organic Rankine Cycle (ORC) is a specific class of Rankine cycle that uses a fluid that is not steam. The various ‘working fluids’ commonly used in ORC systems provide known advantages and disadvantages compared to the steam-Rankine cycle process, summarised in Table 1.1. ORCs are currently far less common than traditional steam-Rankine cycles in real-world applications (Section 1.4).

**Table 1.1: Advantages and disadvantages of ORC cycles compared to steam Rankine cycles. Examples adapted from (Hung, Shai, & Wang, 1997; S. Quoilin, Broek, Declaye, Dewallef, & Lemort, 2013; B. F. Tchanche, Lambrinos, Frangoudakis, & Papadakis, 2011)**

<b>Comparative advantages of ORCs</b>	<b>Comparative disadvantages of ORCs</b>
<ul style="list-style-type: none"> <li>• Choosing a working fluid with a low boiling point can allow for the economic conversion of low-temperature heat resources.</li> <li>• Choosing a 'dry', high molecular weight working fluid can eliminate expensive superheating or reduce turbine strength requirements.</li> <li>• Fluids with high vapour densities can lead to smaller turbine and piping requirements.</li> <li>• No need for de-aeration and demineralisation processes, and non-condensable gases (NCGs) removal systems are often simple.</li> <li>• Condensing pressure is often higher than atmospheric, reducing need for seals to be able to prevent air infiltration.</li> <li>• Evaporating pressure can be lower than steam cycles, reducing the strength requirements of some components, and sometimes removing the need for an on-site operator.</li> <li>• Turbine designs can often be of fewer stages (lower complexity) due to lower pressure ratios.</li> <li>• ORC working fluids with a small density difference between vapour and liquid do not need steam drum or recirculation components.</li> </ul>	<ul style="list-style-type: none"> <li>• Working fluids are more expensive and often less chemically stable and environmentally friendly than steam.</li> <li>• At high temperatures, complex steam cycle systems are capable of higher efficiency than current ORC designs.</li> <li>• ORC Fluids often have poorer heat transfer properties, requiring a larger heat exchanger than an equivalent steam system.</li> <li>• ORC fluids often are more viscous, leading to higher pumping work and piping size requirements.</li> <li>• ORC fluids often have a lower latent and specific heats than water, requiring larger mass flow rates. This leads to larger pipe, heat exchanger and pump requirements.</li> <li>• There is relatively less existing design experience and expertise for ORC turbines than steam turbines.</li> </ul>

Traditional high energy density fossil fuel heat resources are capable of achieving high temperatures, and being economically gathered together to allow for large, centralised systems. This has led to the historic propagation of the steam-Rankine cycle, as it can achieve a good efficiency under these conditions. As concern has grown over the environmental effects and decreasing availability of fossil fuels, interest has shifted to ways to gather and transform lower energy density resources (Hall & Klitgaard, 2012). ORC cycles become relatively more viable when applied to these resources, as they can be simpler and safer than steam plant designs, while working at lower temperatures. This has led to the emerging development of ORCs in smaller, decentralised power generation scenarios (Section 1.4).

## 1.2 ORC Resources and applications

From the 1970s until the mid 2000s, ORCs were primarily developed in order to generate electricity from geothermal resources, in larger systems called 'binary' plants. Over the past decade, interest in distributed generation has grown as a solution to the energy problems facing many modern electricity networks (IEA, 2002), and so with the help of high energy prices and subsidies directed at moving away from reliance on fossil fuels, ORC systems are now also applied commercially to biomass and industrial waste heat resources (Section 1.4). At the same time, the number of commercial suppliers of ORC systems has grown, improving the technology and increasing market competition. More recently, solar energy has also been collected and used in commercial ORC installations, either to supplement an existing heat source, or in stand-alone systems (S. Quoilin, Dumont, O., Lemort, V., 2015; Turboden, 2015).

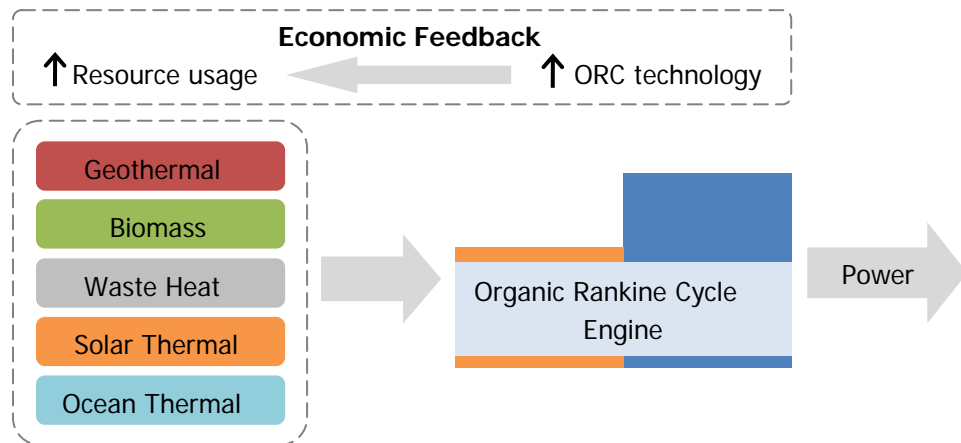

**Figure 1.2: Common ORC resources, and the feedback of an improvement in ORC technology.**

The applications for the power generated by ORC systems vary widely, with the majority of systems being used to provide electricity generation. There is however interest in using ORC systems other applications, such as direct shaft work in industrial plants (S. Quoilin et al., 2013; B. F. Tchanche et al., 2011), thereby marginally improving the overall efficiency and removing the need for a generator, which can be a significant cost at smaller scales (Section 3.1).

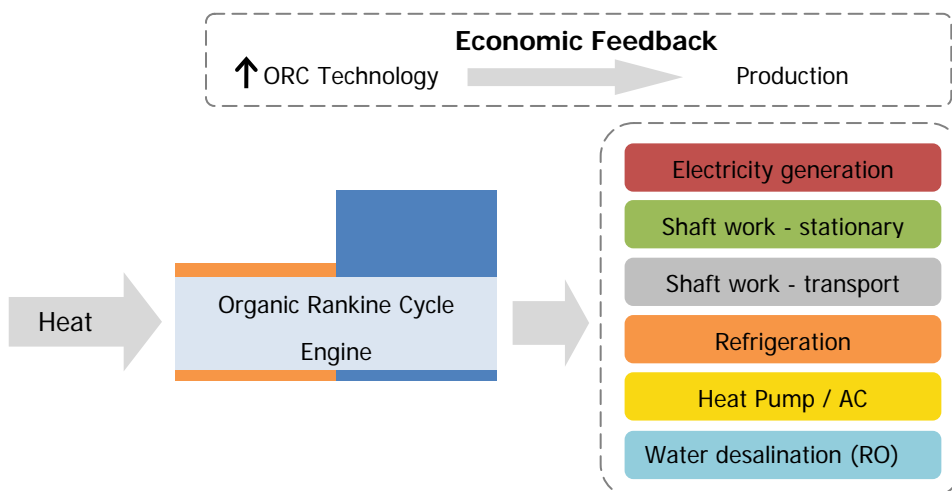

**Figure 1.3: Proposed ORC applications, and the expected follow-on effect of an improvement in ORC technology.**

### 1.2.1. Geothermal

Geothermal ORCs provide a means of centralised, larger scale power production, with the largest geothermal binary (ORC) plant in the world, Ngatamariki, supplying 88 MWe (ORMAT, 2015). While their costs are usually higher than that of flash steam plants (Figure 1.5), they become economic for geothermal resources below around 200°C. Binary geothermal plants also allow for near 100% reinjection of the geothermal brine, helping to maintain the geothermal resource temperature and potentially improving the chance of obtaining resource approvals (Legmann, 2015).

Smaller geothermal plants have also been developed in recent years for lower temperature resources, at sizes of 10 MW down to 200 kW (Turboden, 2015). These plants are often applied near population or commercial centres, to extract power from resources that can then go on to supply other uses, such as recreational hot springs or greenhouses (Karl, 2009).

### 1.2.2. Biomass

Biomass ORCs provide electricity at smaller scales, usually 1 – 10 MWe, as part of combined heat and power (CHP) plants, although commercial systems as small as 46 kWe have recently become available (Electratherm, 2014). Biomass can be an expensive resource in some situations (Section 1.5.2), and steam-Rankine and gasification systems become competitive at scales above 5 MWe (Section 1.6.2). As a result, ORCs are most commonly developed when the following criteria are suitably met (Reisenhofer, 2002) and (Bini, 2010);

- There is an available source of cheap waste wood or other biomass that is suitable as a combustion fuel. As biomass project economics depend heavily on fuel transportation costs, this resource must be near to the plant, or readily available for transport (e.g. next to shipping or railway lines). This is more thoroughly investigated in Section 2.4.
- There is a suitable nearby use for the waste heat as well as the electricity; such as steam for wood processing, district heating or replacing a coal-fired water boiler.
- The heat demand varies, requiring frequent partial-load operation from the system.
- The electricity and heat can be sold at a sufficiently high price.
- A minimal amount of operator supervision is desired.

While there are many places where the above may be the case (The 16MW<sub>th</sub> coal-fired boiler at the University of Canterbury being one example), biomass ORC systems still only comprise 0.72% of global biomass electricity capacity, with the vast majority of electricity production from biomass globally being met using the steam-Rankine cycle (Table 1.5).

### **1.2.3 Waste heat recovery**

Waste heat recovery (WHR) ORCs are also used at smaller scales, with units ranging from 8 MW down to a few hundred Watts (Section 1.4). WHR ORCs usually extract low-enthalpy heat from industrial and commercial processes that would otherwise have not be used directly, but can also be used on higher-enthalpy resources that have a low heat rate. WHR ORCs have the advantage of supplying electricity or shaft work directly to the industrial site, so do not incur transmission and grid connectivity costs.

The most common heat resources to which WHR ORCs are applied are; (from survey results in Section 1.4, (Bronicki L. Y., 2012) and (Bini, 2010).

- Biogas gassifier exhaust and jacket water
- Waste incinerator exhaust gas
- Internal combustion engine (ICE) exhaust gas
- Gas turbine exhaust gas (termed 'bottoming cycles')
- Cement kiln exhaust and clinker cooling fluid
- Steel rolling and forging pre-heating furnaces, and steel thermal treatment systems
- Glass oven exhaust gas
- Gas flaring heat recovery from landfills or industrial residual gas
- Gas pipeline compressor waste heat

Research is underway to develop heat exchangers suitable for waste heat recovery from more difficult heat sources, such as steel blast and electric arc furnaces, with a demonstration project having been successfully completed by the Life EU Heat Recovery in Energy Intensive Industries (HERII) programme in 2013 (Baresi, 2014; Bini, 2010).

### **1.2.4. Solar thermal and concentrating solar**

Similar to biomass, concentrating solar systems primarily use the steam-Rankine cycles for energy conversion in centralised plants (Table 1.6). There is however interest in ORC technology for smaller scale distributed generation, using cheaper low and medium temperature solar thermal collectors. These systems are at the research stage, with two main possibilities being explored; reversible ORC/Heat pump units powered by solar thermal roofs (S. Quoilin, Dumont O., Lemort V., 2015), and low-cost distributed concentrating solar systems (Mario Veroli, 2014). Of the latter, several demonstration plants have been built (Rausch, 2013; Turboden, 2015). Solar CSP has also been used in conjunction with WHR in a 2 MW ORC plant in Morocco (Turboden, 2015)

### **1.2.5 Ocean thermal**

ORCs have been cited as the technology of choice for ocean thermal energy conversion systems (Pelc & Fujita, 2002), which generate power from the thermal gradients that can be found in the tropical regions in ocean. While a 100 kW demonstration plant has been built in Japan (Ikegami, 2013), this resource is still yet to be developed commercially.



## 1.3 Introduction to ORC economics

### 1.3.1. ORCs in the economy

There are many different economic influences that can affect investments into ORCs. They involve several markets such as electricity, steel, carbon, and labour, as well as potential uncertainties around the resource. Consideration also has to be made of both the present and the future economic environment. A summary of the commonly identified factors that affect an ORC's economics are shown in Figure 1.4.

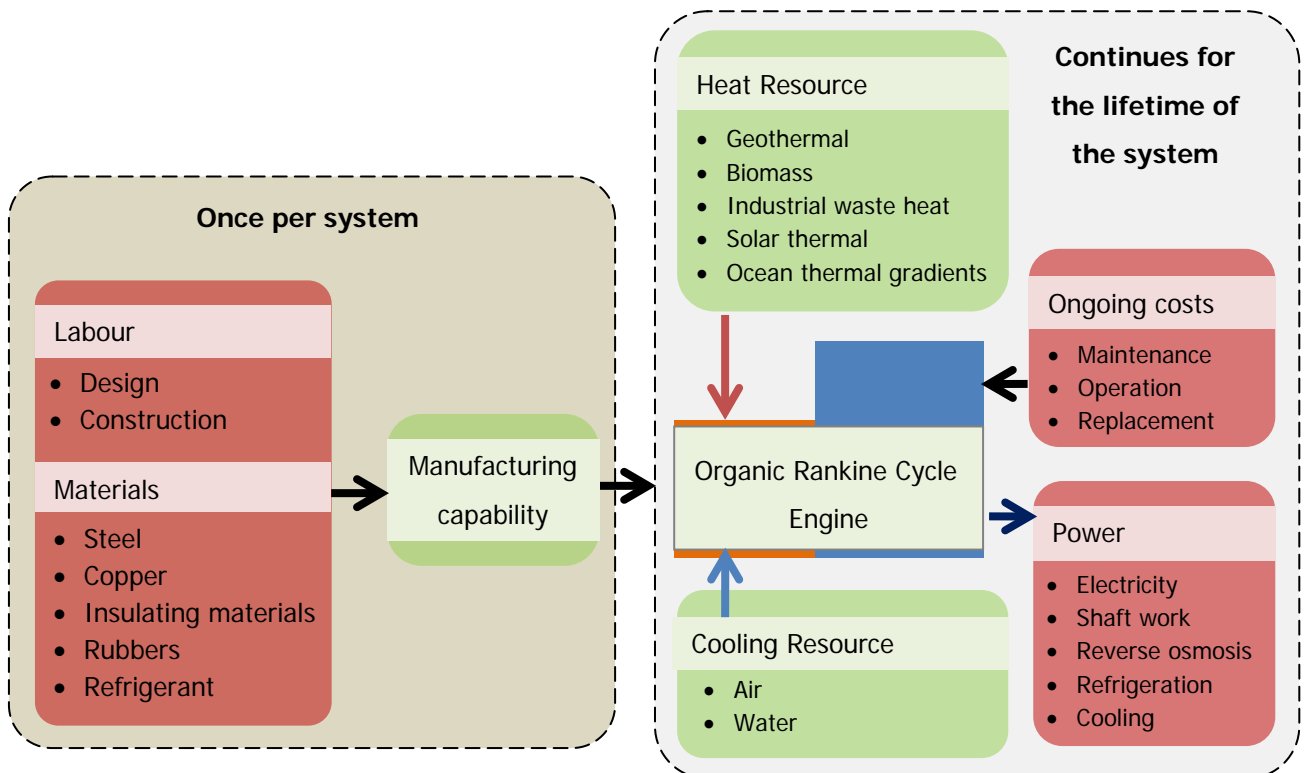

**Figure 1.4: Direct economic and physical inputs and outputs of an ORC system. Sections in green are fixed and unique to the application; these must be factored in when assessing the resource. Sections in red are effectively chosen as part of the ORC design, but must also work within the conditions of the resource.**

ORC systems are usually applied to low value, low energy resources as smaller, decentralised power generation systems (Section 1.2). Waste heat recovery (WHR), geothermal and solar thermal resources are also cost-free, i.e. the economic cost of an additional unit of heat input is negligible compared to the value of that heat once it has been converted into power (S. Quoilin, Declaye, Tchanche, & Lemort, 2011). As a result of these factors, there can potentially be a substantial difference between a design that would provide the best thermodynamic performance and designs that will provide the best economic return (Hung et al., 1997; S. Quoilin et al., 2011). It is therefore considered that in order to improve the applicability of ORC systems in an unregulated market (Figures 1.2 and 1.3), designs should be based on best fulfilling economic criteria.

The design aspects of the ORC can be referred to as the 'technology', as in Figures 1.2 and 1.3. These are the chosen aspects of the ORC design which affect the red boxes in Figure 1.4. Improvements to the technology of ORC systems can primarily be said to improve the investment economics in one of three ways;

- By reducing the specific investment cost (SIC) of the system (Equation 1.1).
- By reducing the ongoing and maintenance costs of the system.
- By reducing the risk associated with the investment.

The risk associated with the investment can be linked to aspects such as technology maturity, safety and reliability. Except where reflected in the O&M cost, specific cost, or discount rate, risk aspects are not examined in this thesis.

The specific cost of the ORC system has the most impact in terms of its investment economics (Fleurbaey, 2012-2013), although both the investment and the O&M costs are often roughly equal over the lifetime of the system (Section 3.1). This is because the specific cost represents the investment required at the beginning of the project, and so is not reduced in significance after the time value of money has been taken into account.

In recent years there have been a number of studies in literature that have presented methods for finding an economically optimal ORC design and applying them to various applications. These studies usually aim to minimise the specific cost of the system, while assuming that the ongoing and maintenance costs are fixed. A meta-analysis of these studies is presented in Section 3.5.

Generally, the expander is a key focus for potentially improving the economics of small-scale ORC systems, through either improved efficiency or lower component cost (Section 3.4.1). For larger scale or very low temperature systems, the heat exchangers become a greater proportion of the overall system cost (Maghiar T., 2001). The size of the heat exchangers often factor into overall system design decisions, with high-pressure system designs offering potential size reductions (Section 3.2) through improved exergetic efficiency.

### 1.3.2. Standard investment evaluation criteria

Studies into the economics of energy projects such as ORCs use several metrics to help determine the viability of a potential investment (Jain, 1999). The standard formulas for these metrics and their use are listed in Table 1.2. Evaluation using these metrics often requires several assumptions to be made, and so more detailed financial studies often use modified formulas to include the risk components associated with these assumptions (Peterson, 2012).

**Table 1.2: Common investment evaluation criteria used in this thesis.**

Criteria Name	Abbrev.	Formula	Use
Specific Investment Cost Equation 1.1	<b>SIC</b>	$SIC \left( \frac{\$}{kW} \right) = \frac{I}{Plant\ Size} \quad (1.1)$	To compare the cost of systems across different sizes.
Simple Payback Period	<b>(S)PP</b>	$PP = \frac{I}{R_t} \quad (1.2)$	To determine the amount of time an investment will be at risk of being a net loss for the investor.
Discounted Payback Period	<b>DPP</b>	$DPP = \frac{\ln\left(\frac{1}{1-I \times \frac{1}{R_t}}\right)}{\ln(1+i)} \quad (1.3)$	
Life-Cycle (total) Cost	<b>LCC</b>	$LCC = I + \sum_{t=1}^n \frac{I_t + M_t + F_t}{(1+r)^t} - S^*$ *Including discounting, (1.4)	To determine whether an investment will yield a net loss or a net profit for the investor.
Net Present Value	<b>NPV</b>	$NPV(i, n) = \sum_{t=0}^n \frac{R_t}{(1+i)^t} \quad (1.5)$	
End-of-life Net Present Value per kilowatt	<b>NPV/kW</b>	$NPV/kW = \frac{\sum_{t=0}^n \frac{R_t}{(1+i)^t}}{Plant\ Size} \quad (1.6)$	To compare yield or loss of an investment across different system sizes.
Internal Rate of Return	<b>IRR</b>	$NPV(IRR, n) = \sum_{t=0}^n \frac{R_t}{(1+IRR)^t} = 0 \quad (1.7)$	To compare investment options without using a discount rate.
Levelised Energy Cost / Levelised cost of Energy	<b>LEC / LCOE</b>	$LEC = \frac{\sum_{t=1}^n \frac{I_t + M_t + F_t}{(1+i)^t}}{\sum_{t=1}^n \frac{E_t}{(1+i)^t}} \quad (1.8)$	To determine the lifetime break-even electricity price.

Where;

$I$  is the total investment outlay (\$)

$R_t$  is the net cash inflow (revenue – expenses) after the initial investment (\$). This is often assumed to have the same yearly value when assessing power plants.

$t$  is the time of the cash flow (in years)

$i$  is the discount rate. A range of methods can be used to determine an appropriate discount rate. See Section 4.3.

$n$	System lifetime
$M_t$	Operations, Maintenance and Repair expenditures in the year $t$
$F_t$	Fuel expenditures in the year $t$
$E_t$	Energy return in year $t$
$S$	is the present-value resale of salvage value less disposal cost

Other investment metrics less common for energy systems include the benefit to cost ratio (BCR) and the Savings to Investment Ratio (SIR).

When communicating the basic economic performance of proposed capital investments in the electricity sector, several key metrics from Table 1.2 are most commonly used (Walter, 1995). These include the net present value (NPV), the discounted payback period (DPP), and the levelised electricity cost (LEC). As can be seen by their equations in Table 1.2, the result of these metrics all depend strongly on the chosen discount rate and project lifetime, as well as factors external to the investor such as the electricity reimbursement price, and the expected specific cost (see Section 1.3.3). The sensitivity of these metrics to variable economic factors when evaluating ORC systems is examined in more detail in Chapter 4.

The result of this sensitivity is that an ORC system that can be expected to become profitable in one economic and resource environment may not be profitable in another, regardless of the quality of the ORC design. This makes it difficult to accurately compare designs from separate sources by using their published economic performance (Section 1.5). As such, the metric that is most commonly used for comparing the economics of an ORC system design is the specific investment cost (SIC), as it is independent of monetary profitability (Equation 1.1).

### 1.3.3. Costs and revenues

#### *Costs*

The economic costs of an ORC design are referred to using four main categories in this thesis; capital (one-off) plant costs, capital resource-gathering system costs, ongoing plant costs, and ongoing resource or fuel costs. This is in order to help separate costs that are affected by the ORC plant design and those that are affected by resource choice (Figure 1.4).

- Initial plant capital costs (C + A in section 3.1). These are all the costs associated with the energy transformation system. In terms of ORCs, this is the total cost of the core ORC system components – heat exchangers, cooling system, pumps, turbine, and generator – as well as the additional costs required to provide an installed system to the customer, such as design hours, auxiliary systems and personnel. Figure 1.5 shows a typical cost estimation curve for the components in this category. These costs are usually focused on when assessing ORC designs in literature.
- Initial resource capital costs (R in section 3.1). These are the costs associated with supplying and transporting the chosen heat source to, and any associated energy products from, the energy transformation system. In terms of geothermal ORCs this may be the costs associated with the geothermal wells, steam field, brine treatment and electricity grid connection. There is often an interrelation between the cost of the resource capital and the ORC system. These costs may be spread over several years before the plant enters commercial operation.
- Ongoing plant costs (O + M in section 3.1). These are the costs associated with the Operation and Maintenance (O&M) of the plant and cooling system. A full-time operator may be necessary for some high-pressure ORC systems, water usage rights may have to be purchased, and grid electricity may be used during start-up. Also included the costs of replacement parts. These costs may vary from year to year, and often escalate over time.
- Ongoing resource or fuel costs (F in section 3.1). These are any costs due to the ongoing provision of the heat resource for the lifetime of the system. For geothermal ORC this may be the O&M cost of the steam field, make-up well drilling and brine treatment chemicals.

There are often interrelations and trade-offs between the cost categories listed above – a reduced capital cost may come at the increase of O&M or fuel costs. These trade-offs may affect different criteria differently – the increased O&M cost may be more welcome in an economic environment where the cost of labour is cheap. In Chapter 2, the costs and revenues of ORC systems are evaluated in terms of energy, thereby helping to indicate the best solutions in terms that do not change (greatly), across the range different economic environments to which ORC machines can be applied.

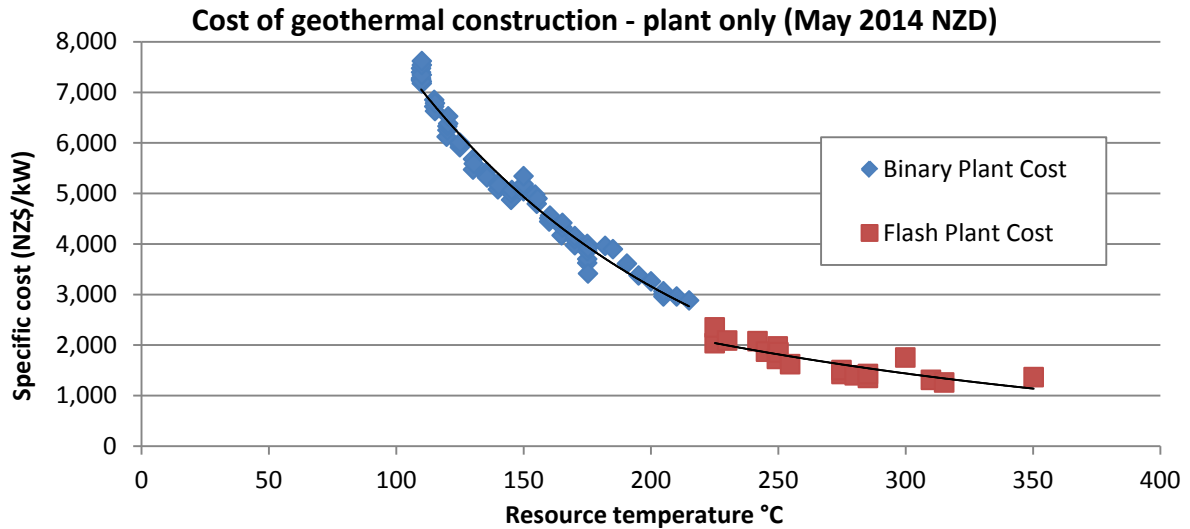

**Figure 1.5: Estimated specific cost of geothermal construction, data from the US Department of Energy GETEM model for a 20 MW geothermal power plant (NREL, 2012). Prices originally in USD, adapted to 2014 NZD using the US PPI and NZD exchange rate.**

For larger projects, another significant cost factor is the time between investments made into the project, and the beginning of revenue production. This is especially important for geothermal projects, where construction usually takes 3 – 4 years, and the entire project time from planning can take up to 13 years (Bloomberg, 2013). A long time delay increases the discounted payback period and reduces the net present value of the system. One method to reduce the impact of this is through using multiple, smaller power generation units (Section 3.3.4).

### **Revenues**

The revenue from power plants such as ORCs are usually calculated for a given time period, often annually, using Equation 1.9.

$$R_t = 8766 \times P_{net} \times P_r \times C \quad (1.9)$$

Where;

$R_t$  is the annual financial benefit from the plant in dollars.

8766 is the average number of hours in a year.

$P_{net}$  is the plant net generation capacity

$P_r$  is the current average price of electricity sold (or paid for).

$C$  is the expected capacity factor of the plant. This is the fraction of expected power output, compared with the potential theoretical output if the plant was running at design conditions continuously.

Revenues ( $R_t$ ) may come from selling the electricity directly to the grid, offsetting grid electricity purchases, or from other non-electricity products from the cycle such as heat and fresh water;

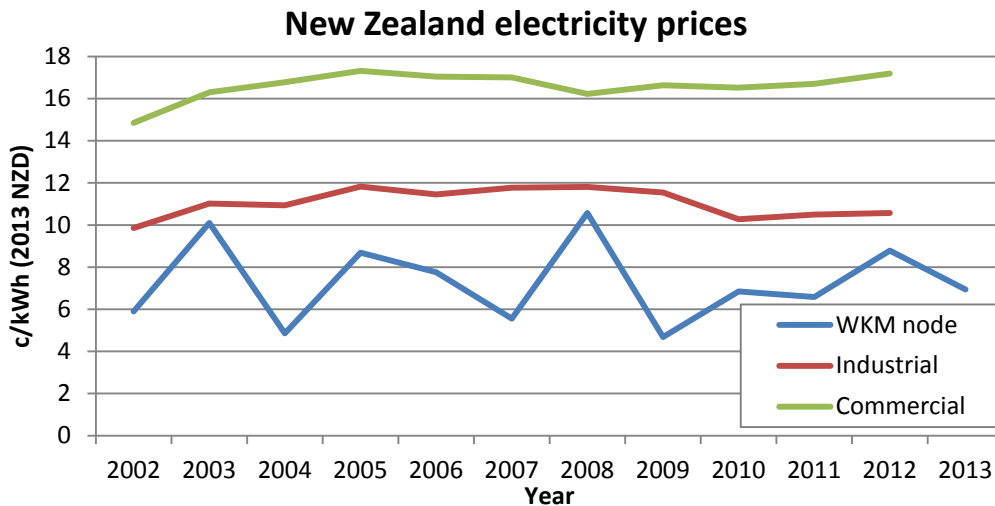

**Figure 1.6: Average New Zealand electricity price for commercial, industrial and average Whakamaru node (near Taupo) final spot price between 2002 and 2013. Node prices shown for 2008 and 2009 are estimated from incomplete data sets. Data adjusted from (Pritchard, 2011), (Electricity Authority(NZ), 2013) and (MED(NZ), 2015).**

Grid sales are sales made by an electricity supplier. This is the traditional point of sale for large, centralised power systems. In New Zealand, most grid sales are made on a spot market, where the electricity price can fluctuate significantly (WKM node in Figure 1.6).

Embedded sales are when an industry can use its electricity generation to offset its own electricity requirements, rather than selling them to the grid. This works favourably towards the capital assessment of electricity saving technologies, such as WHR and some biomass ORCs; embedded sales mean that the return is valued with the buyer's price, which is generally higher and more consistent than the spot price (compare industrial and WKM graphs in Figure 1.7). The return to industrial and commercial producers does however also tend to be valued at a higher discount rate than the energy sector, reducing the advantage of a higher price (NIST, 2013) (Section 4.3).

Returns may also come from non-electricity or power products, such as heat in the case of biomass CHP plants, or fresh water when used to drive reverse-osmosis systems (Schuster, Karellas, Kakaras, & Spliethoff, 2009; B. F. Tchanche et al., 2011).

## 1.4 Current and potential scale of ORC development

### 1.4.1 Past development

As ORC technology has undergone significant commercial development for geothermal and biomass applications since 1988 and 2004 respectively, a look into the past growth of these applications can provide useful insight into how they may be expected to grow into the future. A survey of ORC manufacturers was taken to determine how much generation comes from each resource, and for how long the development of the market for ORC systems has been underway.

Seventeen leading ORC manufacturers were surveyed. The survey data was gathered from manufacturer's websites and case studies. Only installations still currently in operation were included. The survey is not likely to be exhaustive, especially pertaining to smaller WHR and biomass units. A comparable survey has been cited in literature (S. Quoilin et al., 2013) by Enertime, but this survey is limited in that it only presents data until 2006, and does not specify the capacity growth of each resource type. For comparison, the Enertime survey estimates 1000 MW of global ORC capacity in 2006 (Enertime, 2012), while the survey conducted for this thesis estimates 815 MW for the same year, not including any units decommissioned since that time.

**Table 1.3: Total production capacity of ORC systems from 17 major manufacturers, as at the end of 2014. Data from (Exergy, 2015; ORMAT, 2015; Turboden, 2015) and others.**

Company	2014 Capacity (MW)			
	Geothermal	Biomass	WHR	Total
ORMAT	1421.9	0	136.0	1558.0
Turboden	19.2	250.6	41.2	311.0
Exergy	122.5	2.4	3.3	128.3
TAS	22.0	0	134.0	134.0
Maxxtec/Adoratec	0	16.5	6.8	23.4
ENEX	105.3	0	0	105.3
Tri-O-Gen	0	0.3	2.6	2.9
Other manufacturers*	4.8	4.7	8.3	17.9
<b>TOTAL</b>	<b>1705.9</b>	<b>275.6</b>	<b>332.8</b>	<b>2160.3</b>

\*Other manufacturers include GMK, EXERGY, Opcon, Cryostar, BEP-Europe, Bosch KWK, MANNVIT, ENERTIME, ElectraTherm and UTC.

At over 2 GW of total global capacity and a high average capacity factor in the region of 90% (IPCC, 2012), ORC systems are starting to become a significant renewable electricity technology. For comparison, the total capacity of solar PV installations in 2013 was 139 GW with an average capacity factor of approximately 13% (EPIA, 2014), and wind capacity in 2014 was 370 GW with a capacity factor of 28% (GWEC, 2015). In terms of total generation, ORCs systems provide approximately 10.8% and 2.0% as much electricity worldwide as solar and wind respectively.



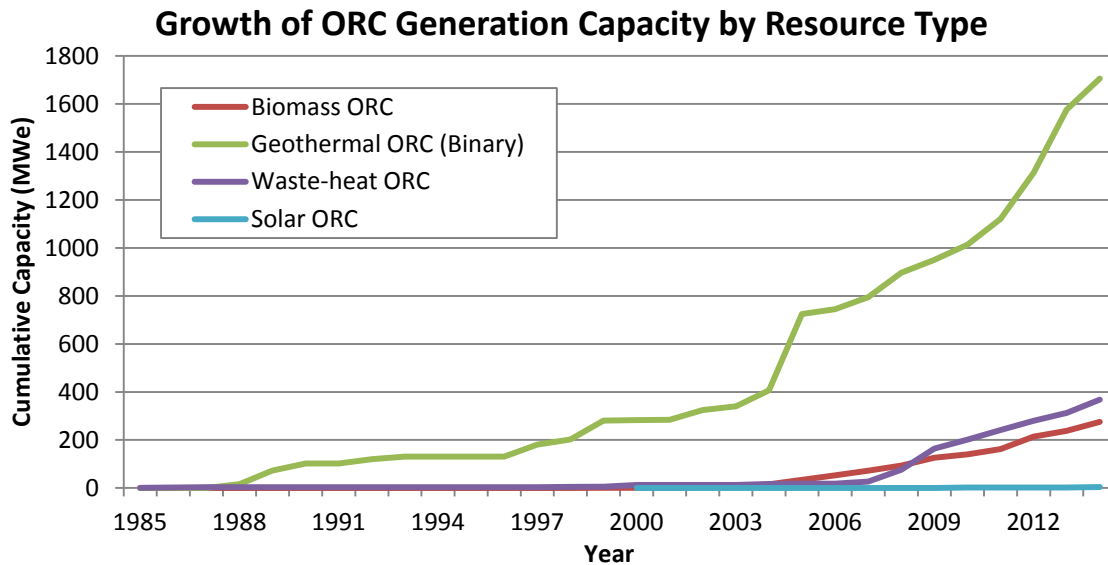

**Figure 1.7: Market evolution of ORC systems by resource type.**

Figure 1.7 shows that geothermal ORC (binary) plants account for the majority of installed ORC capacity, with significant generation having been installed from the late 80's onwards. In 2014, binary ORC systems accounted for about 20% of total geothermal generation. Biomass and WHR ORCs are more emerging products, with global capacity starting to grow from the mid 2000's. The shape of the capacity growth curves indicate that ORC systems have undergone steady growth over the decade since 2005, at what appears to be an almost linear average rate for all systems.

**Table 1.4: Percentage of total generation capacity and ORC unit sizes from survey data, separated by resource.**

Heat Resource	Percentage of Total ORC Capacity	Max Unit Size (MW)	Min Unit Size (MW)	Average unit size (MW)
Geothermal	71.4	95	0.2	13.3
Biomass	13.1	8.0	0.07	1.1
WHR	15.3	5.3	0.0006	0.8*
Concentrating Solar**	0.2	2.0	0.1	0.9

\*Not including numerous very small (0.5 – 15 kW) gas pipeline compressor waste heat systems

\*\* 2MW of concentrating solar generation is from an industrial waste heat/solar hybrid plant.

The survey shows that geothermal ORC systems are on average an order of magnitude larger than ORCs operating from other resources. Biomass, WHR and concentrating solar systems are of a similar average size, but the smallest commercial biomass and solar plants are currently much larger than the smallest WHR systems. This might be due to the additional necessary equipment required to supply and transform biomass and solar resources (such as a boiler system), whose costs do not scale well to smaller sizes. Development is currently underway to bring smaller, domestic-scale biomass and solar powered cogeneration (heat and power) systems to market (Jradi & Riffat, 2014; Qiu, Shao, Li, Liu, & Riffat, 2012; S. Quoilin, Dumont O., Lemort V., 2015).

### Growth of total ORC generation capacity worldwide

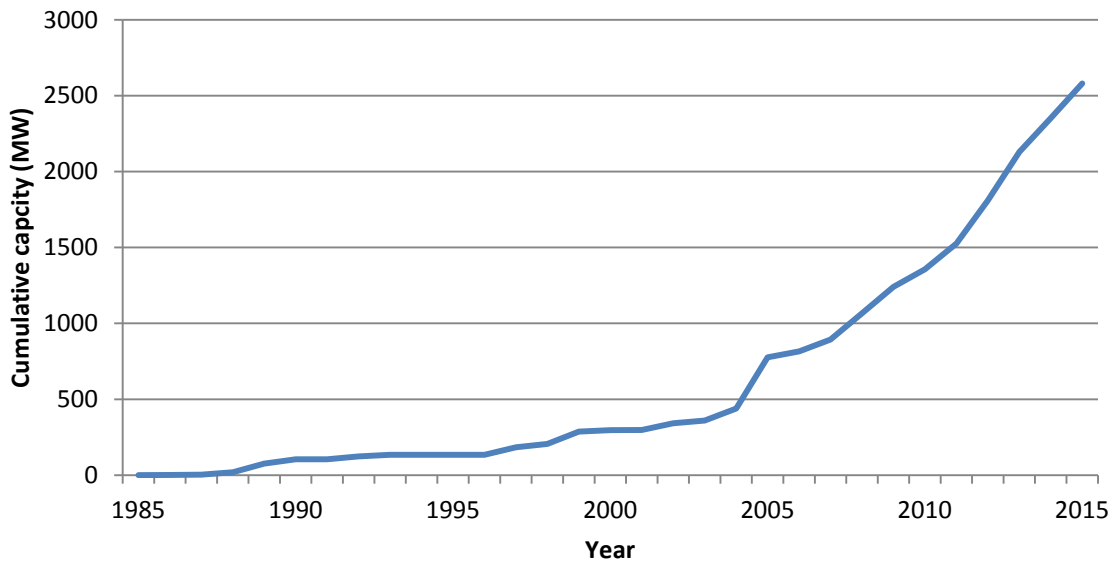

**Figure 1.8: Growth in overall ORC generation capacity including 2015 estimates from projects already underway. A clear linear trend is visible over the past decade, with an average annual capacity increase of 185 MW per year.**

The global cumulative ORC capacity shown in Figure 1.8 also shows steady growth, bolstered over the last decade by the emergence of WHR and Biomass generation capacity.

## Growth in NZ

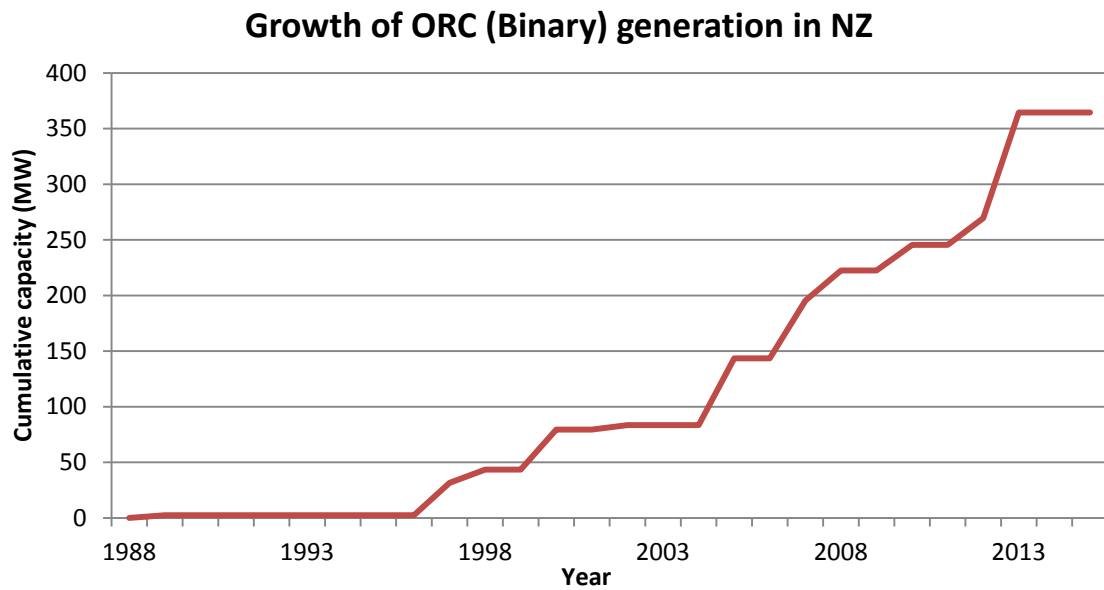

**Figure 1.5: Growth in New Zealand generation capacity of ORC systems. The estimated value for 2015 from upcoming projects is included.**

All ORC systems currently in New Zealand are binary type geothermal units provided by ORMAT. New Zealand binary development has occurred in stages, with plateaus in the early 90's, 2000-2004 and from 2013 onwards (Figure 1.9). Having historically had a low average industrial electricity price compared to the global average, no commercial biomass, solar, or WHR ORC systems are currently installed in New Zealand.

In 2014, the total electricity production from ORC systems in New Zealand was around 3.0 TWh, 7.15% of overall domestic electricity production for the year (MBIE, 2015). This fraction places New Zealand among the countries with the highest proportion of electricity generation from ORCs in world, along with Kenya and El Salvador (from survey). A total of 37% of NZ's currently installed geothermal capacity is from binary type systems, 17% higher than the global average. The majority of available remaining geothermal resources in New Zealand are of a lower temperature than what has historically been developed (Felicito M, 2011), potentially requiring a greater proportion of future development to use binary energy transformation systems.

### **1.4.2. Development potential of ORC resources**

A key factor into whether the current ORC growth rates in Section 1.4.2 can be expected to continue is the size of the available remaining resources, and at what price these resources can be utilised. The general principle of economic energy development means that 'low hanging fruit', i.e. the cheapest resources possible, will initially be utilised. This means that resource extraction costs generally increase over time, while sporadically mitigated by technology developments (Hall & Klitgaard, 2012).

High-side estimates of the total generation potential achievable from ORC systems this century are investigated in this section, to determine if ORC systems will be nearing their resource utilisation capacity in the near future. These resource potential estimates can be considered a capacity 'ceiling', over which further development is not possible within a reasonable time frame.

#### ***Geothermal***

Estimates for the total potential generation capacity of geothermal vary widely, from 70 GW to 2000 GW depending on whether Enhanced Geothermal Systems (EGS) are able to be economically employed (Ungemach, 2010). Current worldwide geothermal capacity is around 8.3 GW, or 0.24 EJ/yr (IEA, 2014). A high range estimate of 2000 GW by GNS science (Chris J. Bromley & Ragnarsson, 2010) assumed that wells of up to 10 km deep are feasible, upon the full deployment of EGS systems. A production capacity of 2000 GW would provide 58 EJ/yr of electricity, meeting 77% of the world's current electricity demand.

Binary-type geothermal systems are expected to be utilised on a growing proportion of geothermal projects, as the hottest available traditional resources have generally been developed, and EGS systems are largely expected to employ binary cycles (C2ES, 2012). As of 2014, binary geothermal capacity is around 1.7 GW or just under 50 PJ/yr (Section 1.4.2.), comprising 20% of total geothermal capacity. Assuming that the fraction of binary-type plants will increase 50% of total geothermal capacity by the end of this century, the estimated potential production from binary systems becomes 29 EJ/yr – 38% of the 2014 world electricity demand.

#### ***Biomass***

Investigations into the energy potential of large-scale biomass farming over the last decade have produced widely ranging estimates of its potential future energy production, from 40 – 1100 EJ/year (Heinimo & Junginger, 2009). Due to the massive range of these estimates, a separate estimate is made in this work with the aim to evaluate the potential increase in biomass production for combustion in ORC units specifically.

The amount of sustainable world forestry production isn't currently known in literature (Lindquist EJ, 2012). A rough estimate is made from the following information; on average, about 0.35% of the world's land has been deforested annually between 2000-2010 (FAO, 2010), whereas 2.5% of

the world's land is estimated to be currently used for productive forest plantation (FAO, 2010). By assuming that the biomass productivity of all forest land is uniform, it is estimated that 86% of production forest can be considered 'sustainable' for the purpose of this investigation, as its use does not imply any further human-caused deforestation.

Two scenarios were investigated, the calculations for which are specified in Table A1.1;

1. Total worldwide adoption of domestic scale ORC biomass systems; resulting in all wood currently combusted for home heating also being used to drive ORC power generation. This scenario is taken to be a more realistic estimate of the maximum biomass potential. Given this scenario, biomass ORC systems are found to have an annual electricity generation capacity of 8.0 EJ (Table A1.1).
2. In developed nations, the total land area devoted to agriculture has been decreasing overall in recent years, and forested land increasing (Bank, 2014). A maximum potential land use change scenario was investigated, such that all land currently used for pastures and meadows is changed into plantation forest to be used exclusively for biomass electricity generation. This extreme scenario has a much larger estimated global energy potential of 1410 EJ, and an electricity generation potential of 280 EJ if used in ORC systems, 3.4 times the current worldwide electricity demand.

The large disparity across the two estimates, as well as the wide variation of studies in literature, indicate that the potential for biomass generation is largely unknown. Of the two scenarios, scenario number one will be used for further analysis, as it does not assume a potentially disagreeable worldwide change to land use.

### ***Waste Heat Recovery***

The potential for low-grade waste heat recovery (WHR) through ORCs is small when compared to Biomass or Geothermal, as the resource is limited to existing heat sources. A survey of the low and high grade waste heat recovery potential for the UK (McKenna & Norman, 2010) estimated that 36 – 71 PJ of heat was available to be recovered annually, although the authors indicated that this estimate is probably lower than the real value.

An estimate of the maximum potential of ORC generation from waste heat recovery is made by assuming that all available waste heat is converted to electricity using ORC systems. If the high-side figure from the (McKenna & Norman, 2010) study is used, and the average conversion efficiency is assumed to be 18%, then 12.8 PJ, or 1% of the UK's current annual electricity generation (IEA, 2014) can be recovered. By assuming that the global potential for the recovery of waste heat for electricity generation is the same as for the UK, then WHR using ORCs could mitigate an estimated maximum of 837 PJ annually, 1% of current world electricity demand.

### ***Concentrating Solar Power***

While employing a stringent land exclusion criteria and a 4.5% average energy conversion efficiency, a study by (Franz Trieb, 2009) estimated a massive global technical potential of 830 EJ of electricity could be generated annually if all suitable available flat land were employed in concentrating solar applications, 10x current global electricity production. The same study concluded that a feasible possible installed capacity for concentrating solar is 0.5 TW by 2050, producing about 6% of current global production with a 30% capacity factor. Another study in the same year published by Greenpeace (Dr. Richter & Teske, 2009) estimated a maximum potential global generation capacity of 1.5 TW by 2050, or 17% of current electricity production. To estimate an end-of-centaury potential, the average of these two estimates was taken and doubled, giving solar CSP a potential annual generation of 20 EJ.

While these studies assume that the CSP plants will use steam-Rankine cycle conversion technology, current temperature limitations for economic solar collectors of around 400°C mean that ORC units may also be used in CSP applications with comparable efficiency (Zarza, 2013). It is assumed for the scenario in this study that these limits cannot be affordably overcome, giving rise to a market takeover of ORC-CSP systems.

### ***Rooftop Solar Thermal***

As a distributed, low energy density system (Section 1.1), rooftop solar thermal energy collectors currently achieve maximum heat resource temperature of around 120°C. ORC systems are a likely conversion technology for this type of system, especially due to their potential ability to work as a domestic heat pump in reverse operation (S. Quoilin, Dumont, O., Lemort, V., 2015). No estimates of the worldwide electricity generation potential from this type of system currently exist in literature.

In the study by (S. Quoilin, Dumont, O., Lemort, V., 2015), an electricity component of 18 GJ/year could be produced through an ORC cogeneration system operating from a 160 m<sup>2</sup> solar roof, about ¼ that of a comparably located fixed solar PV electricity-only system. A review study into the technical generation potential of solar PV systems provides a global potential estimate of 11.3 EJ (Carlos de Castroa, 2015). To estimate the end-of-centaury potential for ORCs, one quarter of the average potential of solar PV was taken, to represent the smaller electricity conversion density of the ORC system. This results in a generation capacity estimate of 2.8 EJ. The actual potential generation from rooftop solar thermal ORC systems is likely to be much less than this estimate, as installations will be constrained to dwellings that can provide very large suitable roof area.

### *Ocean Thermal Energy Conversion*

The resource potential of ocean thermal powered systems is also estimated to be vast. One study (Pelc & Fujita, 2002) estimated that up to 24 EJ could be extracted before the ocean's thermal structure is affected, 30% of current global production. There is however currently only one grid-connected OTEC plant in operation, a 100 kW experimental setup run by Saga University in Japan (Ikegami, 2013). OTEC is the least developed of all current ORC resources, as the extremely large evaporator required means that the technology is currently prohibitively expensive. It is likely that almost all OTEC plants will use ORC machines, in order to accommodate the very low temperature heat used.

### *Summary*

**Table 1.5: Current and potential ORC electricity production, and total electricity production using all conversion technologies, from resources utilised by ORCs. The potential future OTEC production is omitted from the total as it is a very low density energy resource, and so is not likely to be developed within a comparable time scale as the others. Sources (EPIA, 2014; IEA, 2014; IRENA, 2013).**

<b>Resource</b>	<b>Current ORC Electricity Production (PJ/yr)</b>	<b>Current Electricity Production - all technologies (IEA, 2014) (PJ/yr)</b>	<b>Theoretical potential maximum ORC electricity production estimate (PJ/yr)</b>
<b>Biomass</b>	9.1	1,270	8,000
<b>Geothermal</b>	50	240	29,000
<b>WHR</b>	11.5	11.5*	840
<b>Solar CSP</b>	0.035	36	20,000
<b>Rooftop Solar</b>	0.0	615	2,800
<b>OTEC</b>	0.0	0.0	(24,000)
<b>Total</b>	<b>71</b>	<b>2,170</b>	<b>60,640</b>
<b>Current worldwide electricity demand</b>			81,600

\*WHR figure is for low-temperature and discontinuous high-temperature resources only

Table 1.5 indicates that there is significant remaining development potential for the resource types used in ORCs, as they currently sit at around 3.6% of their estimated potential capacity (if developed using ORC systems). Table 1.5 also indicates that ORC technology currently is a minority choice of energy conversion technology, as the majority of development thus far has used steam-Rankine cycles.

Lastly, it can be seen that even with full theoretical resource utilisation, a complete 'replacement' of current electricity generation resources is not possible through the utilisation of ORC systems and their resources alone. Of the resources investigated, geothermal (EGS) and concentrating solar resources are estimated to have the largest potential to provide a significant proportion of current global capacity, at 36% and 25% respectively.

**Table 1.6: Proportion of current electricity generation provided by ORCs, and current global development of estimated potential for ORC resources. Globally developed geothermal capacity without EGS is shown in brackets.**

<b>Resource</b>	<b>Current potential resource utilisation</b>	<b>ORC penetration of current development</b>	<b>ORC global potential resource utilisation</b>
<b>Biomass</b>	15.9%	0.72%	0.11%
<b>Geothermal</b>	0.83% (12%)	20.83%	0.17%
<b>WHR</b>	1.37%	100%*	1.37%
<b>Solar CSP</b>	0.18%	0.10%	~0%
<b>Rooftop Solar</b>	22.0%	none	none
<b>OTEC</b>	none	none	none
<b>Weighted Average</b>	<b>3.58%</b>	<b>3.27%</b>	<b>0.12%</b>

\*WHR figure is for low-temperature and discontinuous high-temperature resources only

Table 1.6 shows a summary of the estimated current development of ORC resources, and the percentage of current electricity production that comes from ORC systems. A significant proportion of ORC resources remain undeveloped for electricity generation. The investigation into potential resource capacity indicates that the development of ORC systems may be limited by the preference for steam systems, the cost-effectiveness of resource development, or the historical market availability of ORC systems, rather than an absolute resource scarcity.



### 1.4.3. ORC capacity at current growth rates

Due to their long history, ORCs systems can largely be considered an established technology in the geothermal and biomass sector. Despite the identified potential for increased competition, it is not likely that the technology will significantly reduce in cost for these resources.

As identified in Section 1.4.2., there are ample remaining resources for the continued development of ORCs. Some factors which may significantly impact the growth rate of ORCs systems are policy changes, increases in the price of other means of generation, or through increased demand for electricity placing upwards pressure on electricity prices. If these factors were to remain unchanged, past growth trends can be expected to give a reasonable prediction of future ORC growth. This is especially true for the more developed geothermal ORCs, but also to a smaller extent for less mature waste heat and biomass ORC technologies.

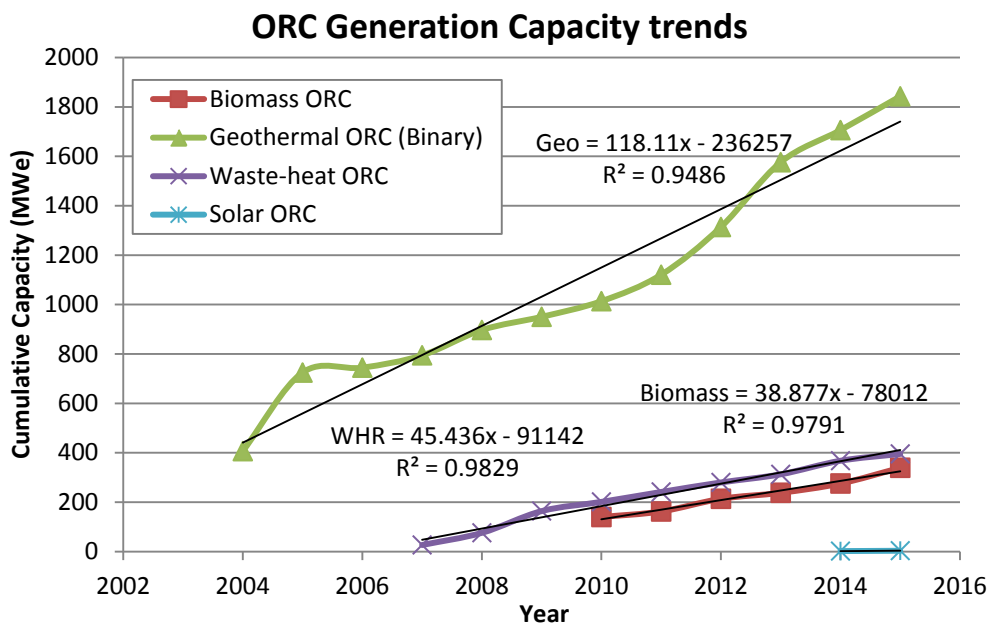

Figure 1.10: Resource-specific linear growth trends for ORC systems.

Figure 1.10 shows the linear-averaged growth trends of ORC systems, as found in the survey in Section 1.4.1. The expected year that these systems will achieve their corresponding production potential as estimated in Section 1.4.2 is shown in Table 1.7 below.

Table 1.7: Years in which ORC systems will reach estimated theoretical potential resource limits, and 5% of current worldwide electricity production, at current growth rates.

Resource	Theoretical future potential (PJ/yr)	Average capacity factor	Year when potential capacity is achieved	Year of 5% current worldwide demand
Geothermal	29,000	0.92	<b>10,457</b>	<b>3,191</b>
Biomass	8,000	0.80	<b>10,158</b>	<b>6,164</b>
WHR	840	0.90	<b>2657</b>	<b>5,168</b>
Solar CSP	20,000	0.30	<b>1,244,717</b>	<b>255,525</b>
<b>Total ORC</b>	<b>57,840</b>	<b>0.88</b>	<b>13,238</b>	<b>2,794</b>

From the results in Table 1.7, it is clear that at current growth rates, ORC systems are not going to meet either the production potentials estimated in Section 1.4.3, or become a significant worldwide (>5% of current demand) electricity source in the near future. As ORC resources cannot be easily transported, their significance will vary from region to region, i.e. assuming a linear growth scenario, regions that already have a high fraction of electricity production from ORC systems, such as New Zealand, El Salvador and northern Italy will continue to gain production capacity whereas regions not currently reliant on ORC systems will not. Whether the historically observed linear growth trends in ORC capacity continues depends on electricity markets, policy and technology prices. In Section 1.4.1 it was identified that solar CSP is currently the most undeveloped of the ORC resources identified, and so this resource can be considered to have the largest potential for a significant reduction in technology prices, leading to an increase in growth rates, given a constant economic environment.

## 1.5 Survey of economic analyses on ORCs

The economics of ORC systems are often analysed in literature and manufacturer reports. A survey was taken of these in order to determine the costs of various ORC designs and the costs of the extraction and conversion systems necessary for each resource. The survey also included details of the assumptions made in each study about their respective economic operating environments. Twenty-three published sets of analyses, detailing both real and theoretical systems were included in the survey; 2 biomass, 7 Geothermal, 4 solar thermal, and 10 waste heat recovery systems.

A summary of the survey results are included in Table A1.2 parts 1 and 2. The prices presented in all the studies surveyed were originally given in USD or Euro and converted to 2014 USD for analysis, using the average exchange rate for the nearest year to publication and the 'ORC price index' developed in Section 1.5.1.

### 1.5.1. ORC price index

The studies surveyed were spaced over a course of 12 years. As a basis for adjusting the historic prices of ORC systems, the 'ORC US Price Index' was developed, based on US price indices, to compare analyses across time as accurately as possible. This index is an estimate only, as is not calculated from actual price variations, and so may not be representative of actual ORC prices.

The index was developed by using the costing sheet of a UTC 280 PureCycle system (White, 2009) as a 'base' budget, and assuming that the economic sectors involved and relative proportion of spending on each to be typical of all ORCs. The closest matching economic sectors available in the US Department of Labor PPI (NAICS system, shown in Table 2.1) were chosen, and an index value was created by weighting each sector by the relative spending on each. The sector with the largest weighting was 'Air conditioning, refrigeration, and warm air heating equipment manufacturing' (NAICS sector code of 333415), as the PureCycle plant is adapted from a UTC refrigeration unit. A breakdown of the budget and corresponding sectors is shown in Table 2.1. The resulting ORC price index from 2000 – 2014 is provided in Table A1.3 and compared with the US average PPI in Figure 1.11.

## Adjusted ORC price index vs. US PPI

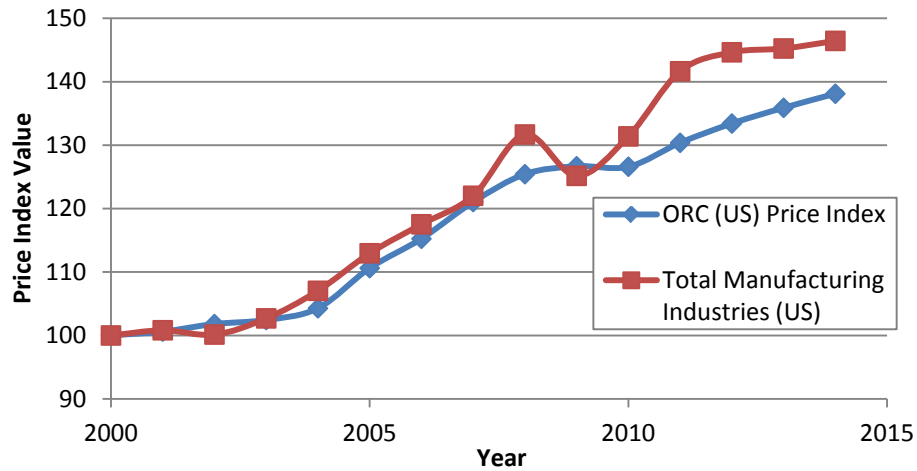

**Figure 1.11: Estimated ORC (US) price index vs. US total PPI. 2000 is given as the basis year with a value of 100.**

Figure 1.11 shows that in general, the estimated price index value for ORC units moved along with the US PPI for all manufacturing industries. Both indexes are increasing over time, but since 2010 the ORC price index has been increasing at a slower rate than the US PPI. This estimate therefore indicates that ORCs are becoming relatively more affordable when compared to other producer investments inside the US.

Further than what is indicated in Figure 1.11, the increasing level of maturity and competition in the ORC market could be expected to put downward pressure on the price of the technology (Section 1.3), although the actual extent of this at this point is unknown. This sort of relative price reduction due to the maturation of ORC technology would not necessarily be included in Figure 1.11, as the index displayed is based largely on the more mature refrigeration and air-conditioning market.

### 1.5.2. Survey results

The average results from the survey arranged by resource type are listed in Table 1.8;

**Table 1.8: Average economic results for each heat resource. All prices are in 2014 USD.**

Resource	Size	System specific cost	Resource temp. (approx)	Economic Lifetime	Policy Support	Elec. Price	Disc. Rate	LCOE	DPP	NPV / kW*	Selling exhaust heat
Unit	MW	\$/kWe	°C	Years	%	\$/kWh	%	\$/kWh	Years	\$/kWe	%
Biomass	0.7	\$3,638	275	10	100%	\$0.24	6.0%	\$0.16	4.0	\$898	100%
Geothermal	2.2	\$3,879	168	24	14%	\$0.10	6.1%	\$0.07	6.5	\$5,427	29%
Solar	0.5	\$7,217	128	21	100%	\$0.36	3.5%	\$0.13	6.6	\$10,909	25%
WHR	1.5	\$5,030	258	15	60%	\$0.20	5.6%	\$0.09	4.7	\$7,946	30%

\*The NPV/kW value is given using a NPV determined for the end of the system lifetime.

Table 1.8 shows that while the systems investigated are of similar scales, they vary greatly in specific investment cost. The solar and WHR systems in the survey were found to be much more expensive on average than the biomass and geothermal plants.

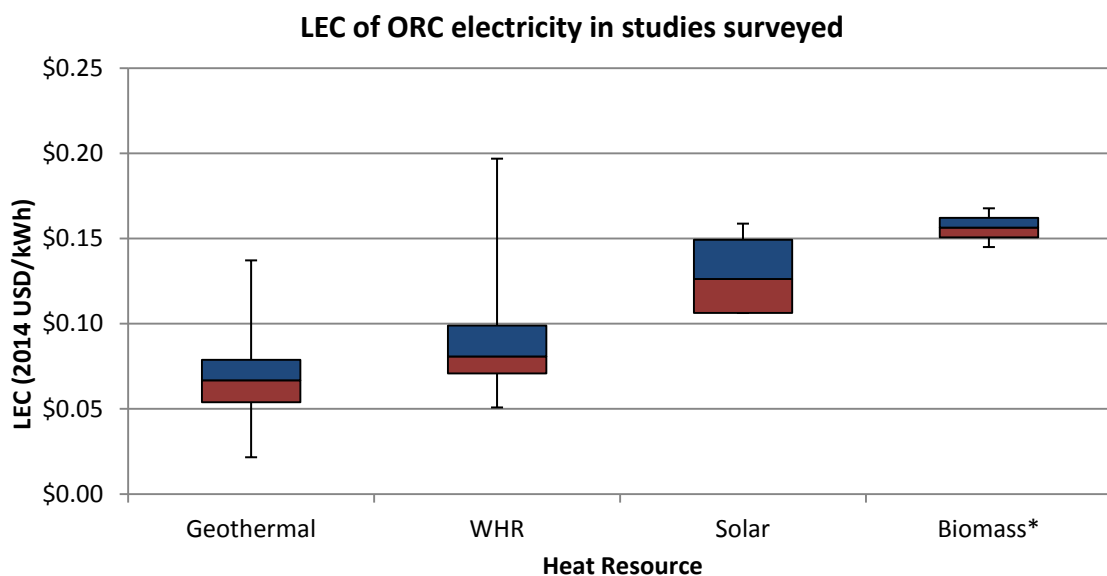

**Figure 1.12: Box-and-whisker plot of levelised electricity cost of ORC systems, grouped by heat resource. The min, max, median, and upper and lower quartile values are indicated by this plot type.**

\*Only two biomass ORC systems were included in the Survey

Figure 1.12 shows that the lifetime levelised electricity cost (Equation 1.8) varies widely across the studies, with geothermal having a minimum LEC of 2.2 US c/kWh, and WHR having a maximum of 19.7 US c/kWh. The sample size for the biomass resource is too small to draw a strong conclusion, but the LEC of the solar systems surveyed appears to generally be above that of the geothermal and WHR systems.

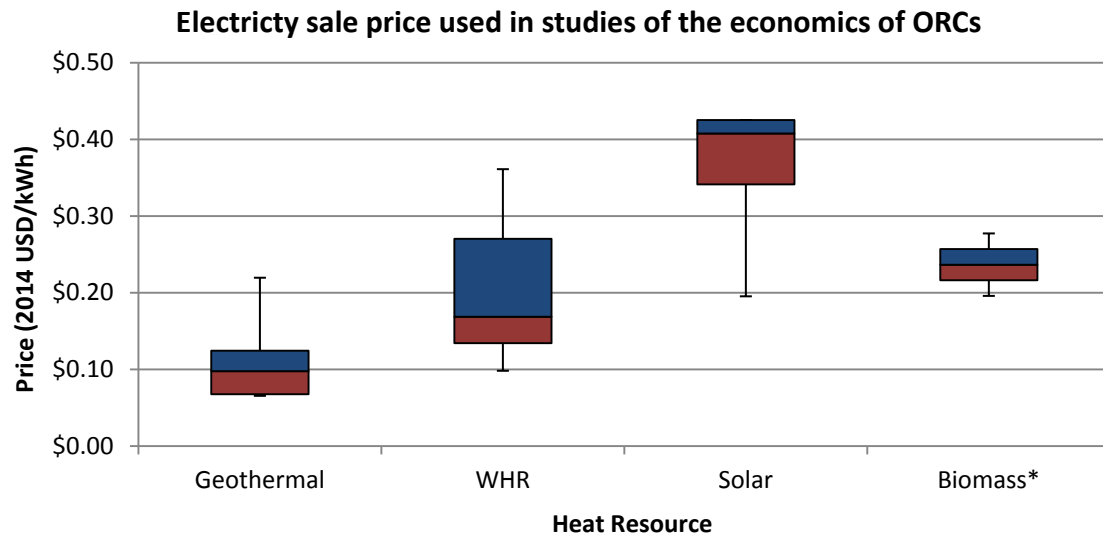

**Figure 1.13: Box-and-whisker plot of the Electricity sale price used for the economic studies surveyed, arranged by heat resource.**

Figure 1.13 shows that the average electricity sale price is widely different for systems operating from different resources. This can be largely explained by two factors;

The level of policy support – concentrating solar and biomass have the first and second largest electricity sale prices in the studies surveyed, but were also supported by policy mechanisms in all cases surveyed (Table 1.8). This support was usually described in the studies to be feed-in-tariffs, which increase the effective electricity sale prices used. Waste heat recovery systems are also described as having policy support in a significant proportion of studies.

Location of system – both of the studies on biomass systems, three out of four of the solar and the majority of the WHR studies were on ORCs based in Europe. The average after-tax industrial electricity price in Europe in the last decade has been significantly higher than the other countries surveyed, at 9.0 – 32.1 US cents /kWh in 2013, with an average of 14.5 c/kWh. For comparison, the other countries included in the studies (US, Indonesia, South Korea and New Zealand) had average electricity prices ranging between 6.8 – 8.1 US c/kWh in the same year (DECC, 2014)(ClimateScope, 2014).

The wide variation in electricity prices across the studies can be expected to lead to a large variety of economic outcomes. I.e. the resource that achieved the highest average net present value / kW (EOL NPV / kW) was solar, despite having the largest specific investment cost and smallest capacity factor. This is because the solar studies on average used the highest electricity reimbursement rate, the lowest average discount rate, and the second highest economic lifetime of the resources investigated (Table 1.8).

### 1.5.3 ORC systems in New Zealand under future electricity demand and energy prices

In this section, the costs of the ORC systems surveyed were compared with the price that an industrial investor might be expected pay for WHR ORC systems in 2013, 2025 and 2040, using electricity price projections from the New Zealand Ministry of Business, Innovation and Employment.

A maximum economic price was determined to be a SIC such that the discounted payback period (Equation 1.3) was five years, given the following assumptions;

- A discount rate of 5%.
- A capacity factor of 92%. This is roughly applicable to geothermal, WHR and some biomass systems, but not to solar resources. The SIC of the solar systems was multiplied by three to correct for this.
- The average industrial electricity price in NZ was 8.1 US c/kWh in 2013 (DECC, 2014), with a 17% increase by 2025 and a 28% increase by 2040.
- An annual O&M cost of 2%.

The assumed future NZ electricity price increase is estimated using the four projections in *Electricity Insight 2013* (MED(NZ), 2013). The projections have been averaged, with a double weighting for the 'mixed renewables' scenario, as this was given as a business-as-usual case.

The economic SIC for an industrial user at these points in time vs. the SIC of the real-world ORC and binary plant systems included in the survey are shown in Figure 1.14. The figure shows that under current projections, the electricity price in New Zealand is not expected to increase significantly enough to provide favourable economics for an industrial investor in a wide range of ORC applications. One application that might become economic under future electricity price changes in New Zealand is waste heat recovery from the exhaust gas of a steel preheating oven. As New Zealand's only steel smelter, this would be apply to NZ Steel specifically, which does not currently appear to run a continuous steel preheating process (A. Finch, 2012), and so any WHR ORC system would have a lower capacity factor and higher SIC than indicated by Figure 1.14 (Section 3.3.2).

### Minimum electricity price for potential ORC/Binary generation projects in NZ

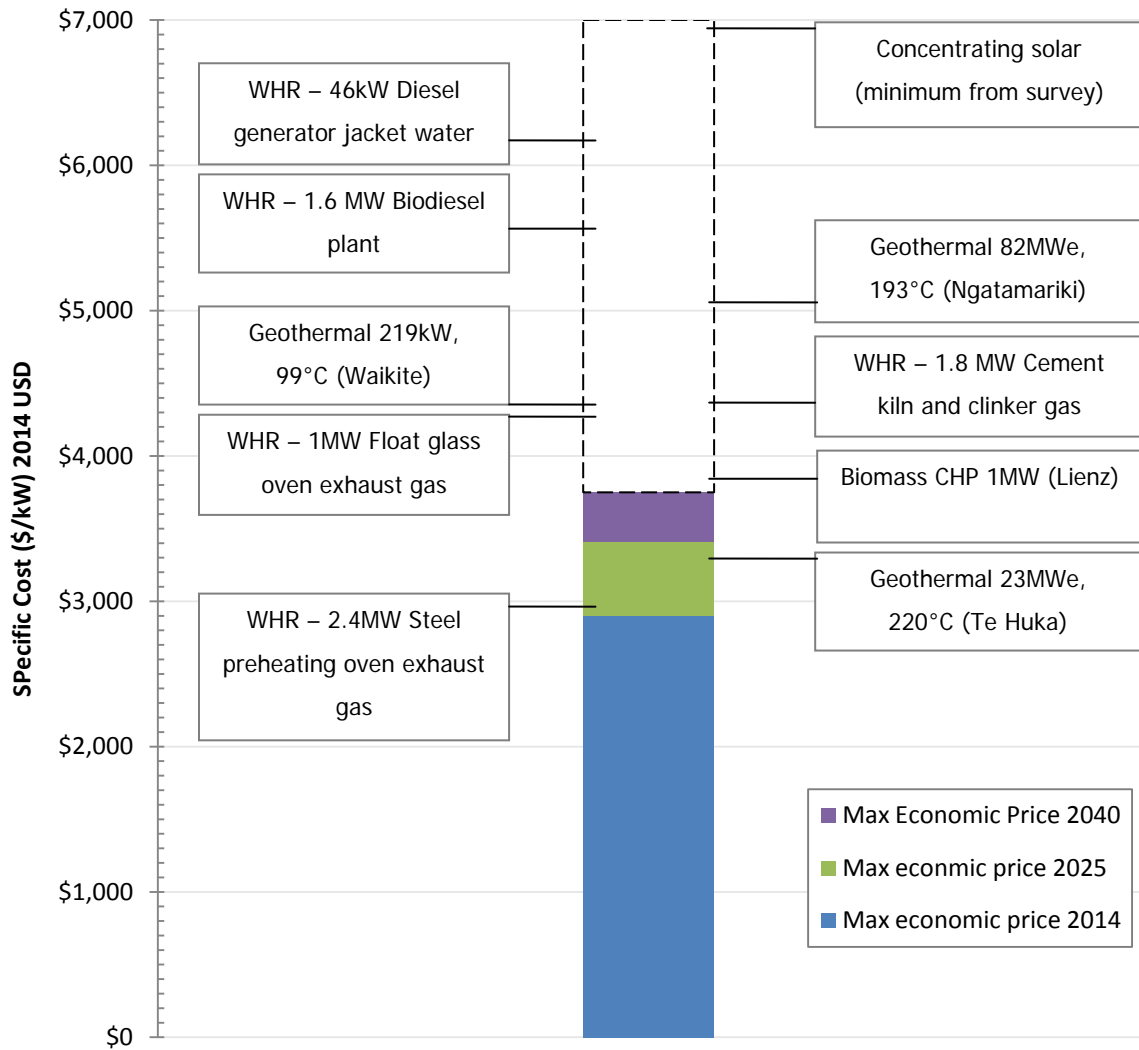

**Figure 1.14: The maximum capital cost of an (ORC) power generation system that will yield a discounted payback within 5-years for an industrial user in New Zealand. Specific capital cost of several real-world power generation systems using ORC technology are also indicated for comparison.**

Applications that are near the economic maximum may still be pursued given other benefits, such as an eco-friendly image, the wish to reduce a plant's electricity price exposure (risk reduction), or economic criteria that is more favourable to capital investment. Some investors may also accept a much longer payback period criterion than the five years assumed; explaining for instance the building of the Ngatamariki plant, despite its high SIC.



## 1.6 Competing technologies

### 1.6.1. Geothermal competing technologies

Binary geothermal plants constitute about 20% of geothermal capacity today, with about 60% of geothermal production being from single or double-flash steam plants, and about a further 20% from dry steam generation (DiPippo, 2011).

There are currently no competing electricity generation technologies for geothermal binary plants at temperatures below 160°C (Felicito Gazo, 2010). At temperatures between 160 – 200°C, either flash or binary technology are used depending of a variety of factors, such as condensing temperature, desired reinjection percentage, and technology cost. Some resources are also unsuitable for flashing due to their geochemistry, limiting the technology choice to binary systems (DiPippo, 2011). This has resulted in some binary plants having a nominal brine source temperature as high as 247°C (DiPippo & Moya, 2013).

Direct use of geothermal fluid can be considered a source of competition for geothermal resources that are located near potential industry or commercial centres. Although most direct heat uses are at a lower enthalpy than electricity resources, some uses such as paper pulp digestion can require large amounts of heat at temperatures as high as 180°C (Felicito Gazo, 2010). Direct heat use currently provides about five times as much energy as geothermal electricity, at efficiencies of 80% or greater (IEA, 2010).

### 1.6.2. Biomass competing technologies

ORCs are currently the most significant alternative to steam-Rankine cycles for the conversion of heat to electricity using biomass. A summary of commercial-stage biomass energy conversion technologies and their installed generation capacities are listed in Table 1.9;

**Table 1.9: Estimated current worldwide commercial production capacity of biomass-electricity conversion technologies.**

<b>Biomass-Electricity by technology Type</b>	<b>Power (MW)</b>	<b>Source</b>
<b>Gas Engine</b>	4.3	(Hrbek, 2015)
<b>Gas Turbine</b>	13.3	(Hrbek, 2015)
<b>ORC (incl. units being built in 2015)</b>	339.0	Own Study
<b>Stirling</b>	0.3	(Hrbek, 2015)
<b><i>Steam Rankine (IEA - estimated)</i></b>	<i>49,100</i>	<i>(IEA, 2014)</i>

### ***Steam-Rankine Cycles***

Biomass ORC systems comprise a total of 0.72% of global biomass-electricity capacity (Table 1.5), with the vast majority of electricity production from biomass globally being met using the steam-Rankine cycle. Unlike with other resources, steam-Rankine systems do not have a significant efficiency advantage over ORC in biomass applications, as they both work at similar temperatures of 300-400°C with efficiencies of around 15-20% (Jan Brandin, 2011). Steam cycles are however more proven for large-scale operations >5MWe, and have enjoyed the historical market advantage at this size range.

New Zealand's only industrial-sized wood biomass CHP plants at Kinleith (40MWe) and Pan Pac (13MWe) use steam cycle conversion technology. As these plants are used primarily to generate steam with electricity as a by-product, the electrical efficiency may not be a significant purchase consideration for these users.

At smaller scales, biomass ORC systems are beginning to be favoured over steam cycles (Obemberger, 2008), due to the following practical advantages;

- A relatively low-complexity design with a comparable efficiency.
- Low operating and maintenance costs.
- Low pressure operation and low personnel requirements (A typical 1MWe plant requires 3-5 hours per week).
- Favourable partial-load efficiency.
- Low noise level

While these advantages have led to the observed growth in small-scale biomass ORC systems, novel technologies currently at their development stage may soon eclipse ORC development. These technologies, especially gassifier-gas turbine systems, promise much greater fuel-electricity conversion efficiencies than what can be achieved by Rankine cycles (Rutherford, 2006).

### ***Biomass gasification and pyrolysis***

Biomass gasification (also called wood gas generator or biomass syngas) uses a chemical process to convert solid biomass into a gas mixture consisting of mostly carbon monoxide. Some gasification plants alternatively convert biomass into primarily oils using pyrolysis, which can be applied to the same cycles as gasification. The gasification process typically has fuel-to-product efficiencies between 70%-80%, depending on the scale and the fuel used. The gas produced can then be used in a variety of processes, including an efficient high-temperature power cycle. Gasification is theoretically favoured for larger plants when electricity production is of high importance, but few commercial plants exist as of 2015, according to the by IEA Task 33. report (Hrbek, 2015).

In general, gassifier and pyrolysis systems often require significant man-hours of additional cleaning compared to solid fuel boilers, which may make them unsuitable for smaller, distributed plants and some fuel types (Reisenhofer, 2002). Gassifier technologies are still in early development however, with newer systems advertising reduced cleaning times.

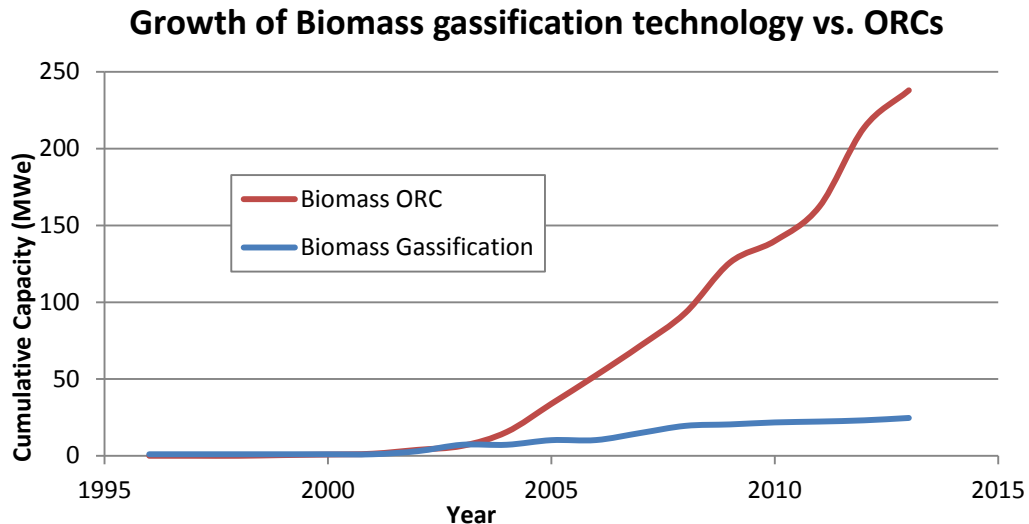

**Figure 1.15: Capacity growth of biomass ORC and biomass Gasification systems. Numbers from (Hrbek, 2015) and own study. 2014 results are omitted as they are likely to be less complete and so less representative.**

In terms of biomass-to-electricity production, a system which offers a high electrical efficiency at a low capital cost is preferred. As such, gas and liquid-fuel burning systems using ICE and Otto engines at medium scales (<10MWe), and Gas Turbines at micro scales (>1MWe) theoretically best achieve this goal. Although there are an increasing number of commercial installations using gasification technology (Hrbek, 2015), biomass-gas turbines have not yet reached the commercial stage at large scales (>10 MWe), where their greatest efficiency is promised. One reason for this is that they are seen as a more risky technology, with a high capital cost and as-yet unproven operation using many biomass fuel types (Rentizelas, Karellas, Kakaras, & Tatsiopoulou, 2009). As of 2014, ORC cycles the most widely installed of the emerging biomass conversion technologies, especially in Europe, with numerous installations at scales around 0.5-3.0 MW.

The annual production of ORC (and gasification) systems appears to be steady, and not growing significantly (Figure 1.16), and so can be expected to remain as a small proportion of total biomass electricity production capacity in the short term. In the long term, the higher efficiencies offered by large biomass gas turbine (BIGCC) systems could potentially incentivise large industries to switch from the steam cycle in situations where hot steam requirements are already met or unnecessary, and a greater proportion of electricity production is desired. If this scenario were to occur, ORC systems have the potential to be significantly implemented as a bottoming cycle in BIGCC power plants (Rauch, 2014).

### **1.6.3. Waste heat recovery competing technologies**

The main competition for ORC systems in waste-heat to electricity conversion is from thermoelectric material systems that utilise the Seebeck effect. These materials create a current when a temperature difference is applied across them, to directly convert a heat difference into electricity. Until recently, the best thermal electricity conversion was achieved at high temperature ranges ( $>900^{\circ}\text{C}$ ) with expensive solid thermoelectric materials (Rowe, 2005), reaching 5-8% efficiencies in ideal high temperature, low heat flux environments (Snyder, 2008). The production cost of this technology is very high however, at around \$25,000/kW, and very energy intensive, so no commercial developments based on this technology exists at this time (BCE, 2008).

The most recent developments in thermoelectric materials have focused on much cheaper organic liquid solvents that work best in the  $100\text{--}200^{\circ}\text{C}$  range (Abraham, MacFarlane, & Pringle, 2013). A 25 kWe demonstration unit using this system was developed in 2014 by Alphabet Energy, which gathers heat from a large 1.0 MW diesel engine (AlphabetEnergy, 2015). While the systems offer simple installation, their cost is currently unknown and their applicability is limited by their low electrical density, at around  $0.5\text{ Wm}^{-2}$  (Abraham et al., 2013).

### **1.6.4. Solar competing technologies**

Solar ORC systems face strong competition from Steam-Rankine cycles in concentrating solar applications, and from solar PV in rooftop applications.

Global solar ORC systems currently comprise about 0.1% of global installed CSP capacity (Table 1.6), with almost all commercial systems using steam-Rankine cycle conversion technology (IRENA, 2013). Solar ORC applications may have advantages in smaller, distributed systems however, where the medium-temperature solar collectors can be made out of more readily available materials (Mario Veroli, 2014). Concentrated solar collection may also provide useful supplement energy for ORC resources that are intermittent, such as in the Ali Baba plant in Morocco (Turboden, 2015)

Solar PV is an established technology, with an installed capacity of 140 GW, and average efficiencies of around 14% (EPIA, 2014), about twice that of low-temperature solar ORC designs (S. Quoilin, Dumont, O., Lemort, V., 2015). Solar ORCs may however offer advantages over solar PV installations in reversible heat pump systems, as in these applications they can eliminate redundancy (S. Quoilin, Dumont, O., Lemort, V., 2015), and use more readily available components and materials. Solar thermal collection may also provide useful peak-load energy to the outgoing heat stream for CHP plants, such as in the Lienz plant in Austria (Reisenhofer, 2002).

## 2. Energy Return on Investment (EROI) of ORC systems

---

### 2.1 Introduction to EROI

Energy production systems such as ORCs are required to produce surplus energy beyond the energy that it cost to set the system in place. If the system cannot do this, it will fail over time as an energy producer. An efficient market economy is expected to select production processes that provide large surpluses where possible, thereby providing the maximum useful function and generating the most wealth. Economic measures such as cost/benefit analysis however do not measure the energy provided to and from the system directly, and so can be influenced by temporal market distortions such as exchange rates, subsidies, interest rates, the cost of labour and electricity prices (Chapter 4). Measuring the return on investment in purely energy terms allows for a physically grounded comparison of what systems are likely to thrive over time as an energy provider, and what ones will require further development before they can be expected to facilitate a wealthy society, if at all. This chapter investigates the Energy Return on Investment (EROI) of existing ORC technology operating from multiple resource scenarios, and determines where ORC plants can be most fruitfully implemented in the long term.

The ability of humans to effectively exploit energy resources and utilise energy surpluses is a key determinant of material wealth on personal, cultural, and societal levels (C. A. S. Hall & Klitgaard, 2012). Energy surpluses can be used to facilitate the division of labour, creation of specialists, growth of cities and infrastructure, personal wealth, art and culture.

Energy Return on Investment (EROI) is the ratio of the energy delivered to society over the energy required by society to produce that energy delivery.

$$\text{EROI} = \frac{\text{Energy Delivered by a process}}{\text{Energy Supplied to a process}} = \frac{D_{\text{TOTAL}}}{S_{\text{TOTAL}}} \quad (2.1)$$

EROI shows the magnitude of the yield from an investment in terms of energy, and can increase or decrease over time for a specific energy resource (C. W. King & Hall, 2011). EROI has been demonstrated to be a measure of an energy source's capacity to facilitate net economic growth, as indicated by Figure 2.1 (Cleveland, Costanza, Hall, & Kaufmann, 1984; Murphy & Hall, 2011). The EROI value of a technology can be used in comparison with competing technologies, absent of economic influences such as subsidies, government provisions and the time value of money (Cleveland et al., 1984). Although particular components of the economy may successfully operate at low EROI, e.g. batteries or algal biofuels (Beal, Hebner, Webber, Ruoff, & Seibert, 2012), studies have indicated that net growth cannot be facilitated when an overall societal EROI falls below 5-9 (C. Hall, Balogh, & Murphy, 2009; J. G. Lambert, Hall, Balogh, Gupta, & Arnold, 2014).

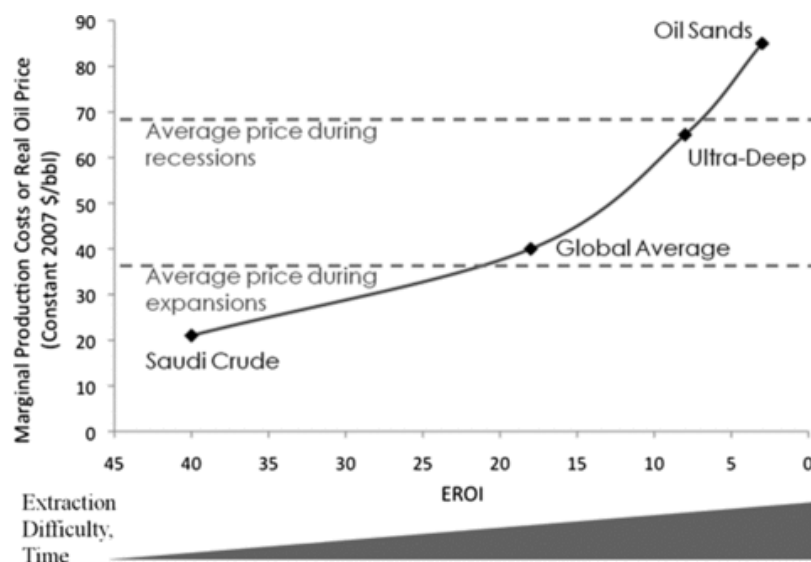

**Figure 2.1: Oil production costs from various sources as a function of the EROI of those sources. The dotted lines represent the real oil price averaged over both US recessions and expansions during the period from 1970 through 2008. Image Fig. 16 in ‘Energy return on investment, peak oil, and the end of economic growth’ (Murphy & Hall, 2011). Data sources are included in references section. Reproduced with publisher’s permission.**

Previous studies into the EROI have largely focused on the major global energy carriers, oil and coal. These studies have determined that the EROI of oil has decreased over time, as the remaining available resources have become increasingly difficult to gather. A study by (Cleveland, 2005) showed that the EROI for U.S. oil reduced from over 25 in the 1970s down to less than 20 by 1997. A study by (Gagnon, Hall, & Brinker, 2009) indicated that the EROI for global oil has shrunk from a local peak of 35 in 1999 down to approximately 18 in 2006. A survey of EROI results in a thesis by (Dale, 2010) indicates that the EROI of US oil decreased from around 100 in the 1930’s, to between 10 and 30 from 1955 – 2010 for conventional oil production. Fields that are nearing exhaustion have been estimated to have EROI values closer to 10 (Dale, Krumdieck, & Bodger, 2011; C. W. King & Hall, 2011).

As a result of increasing international concern over the future supply, and the global warming effects of burning fossil fuels, an increasing amount of energy demand from electricity powered infrastructure is anticipated (IEA, 2013). Coal currently accounts for approximately 40% of global electricity production, with oil and gas plants making up a further 28% (IEA, 2014b). Calculated EROI values for coal at the mine mouth are in the 30 to 80 range (Cleveland et al., 1984; J. H. Lambert, C.; Balogh, S.; Poisson, A.; Gupta, A, 2013), although the EROI for coal-generated electricity can be considered much lower at around 14 (Dale, 2010). The decreasing EROIs of oil reserves can also negatively impact electricity generation, since less net energy is available for coal’s mining and transport. EROI results for electricity and thermal energy sources cannot be directly compared without the use of a correction factor, due to the utility difference between these energy types. A selection of EROI results for thermal energy types are shown in Figure 2.2.

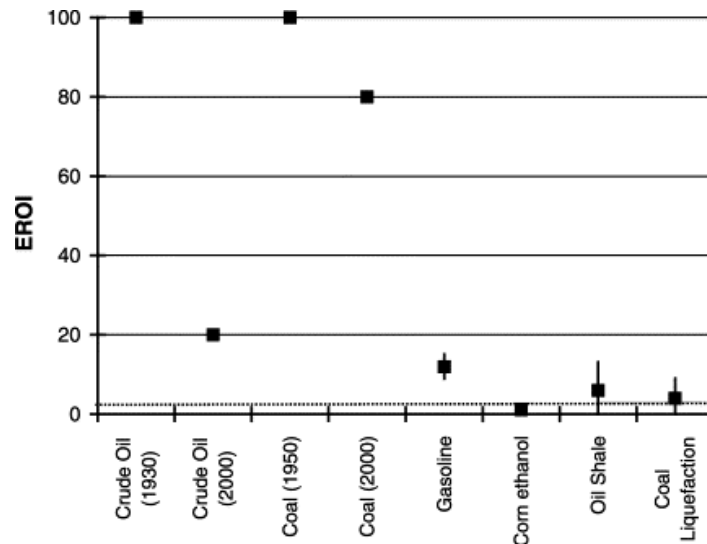

Figure 2.2: EROI for significant conventional and emerging thermal energy sources. The dashed line towards the bottom represents the energy break-even point. Image Fig. 6. in 'Net energy from the extraction of oil and gas in the United States' (Cleveland, 2005). Reproduced with publisher's permission.

ORCs are often applied to thermal resources that are at too low of a temperature to be able to produce electricity economically using a traditional steam plant (Section 1.1). These resources are commonly renewable or 'free' resources such as low-temperature geothermal, biomass, industrial waste heat and solar thermal applications. Renewable electricity generation systems currently provide 21% of global electricity generation and their market share is growing steadily (IEA, 2014a). As shown in Section 1.4, Organic Rankine Cycle generation systems currently only account for a very small fraction of global electricity generation, at just under 0.1%, although the installed capacity is steadily increasing (Quoilin, Broek, Declaye, Dewallef, & Lemort, 2013) and Section 1.4.

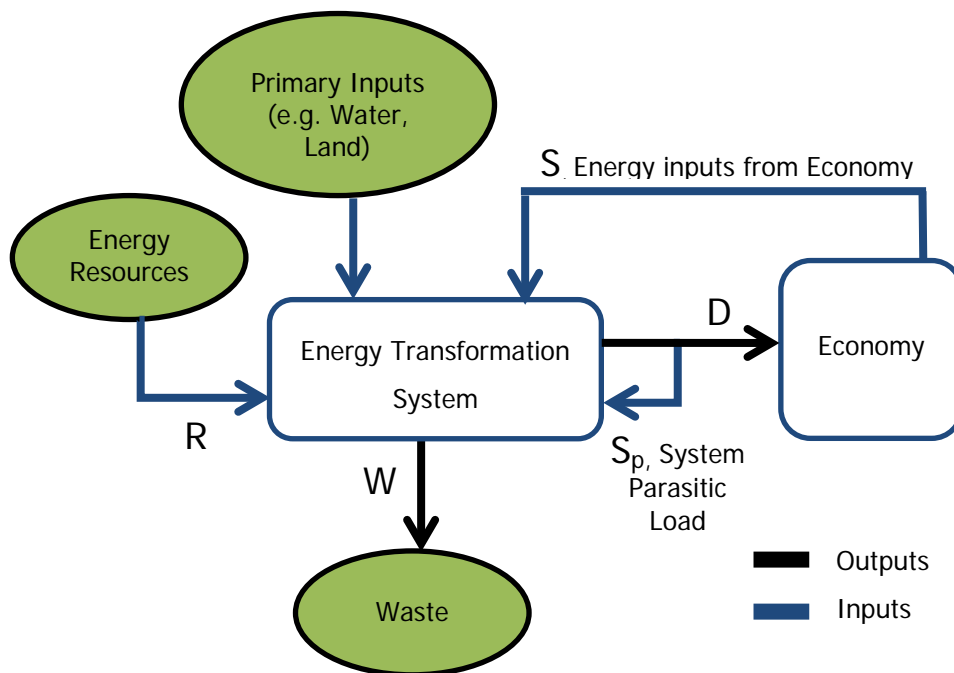

Figure 2.3: Diagram of the Energy-Economy system as defined for the analysis. Adapted from (Dale, 2010).

## 2.2 Methodology

### 2.2.1 Development of methodology

Recent studies on EROI have used a range of methodologies. A methodology is often chosen to best compare relevant aspects of a certain technology.

An attempt has been made by (Mulder & Hagens, 2008), to define a standard methodology for EROI analysis. Included in this methodology are various categories of EROI based on the chosen system boundary. This methodology was further refined by (Murphy et al., 2011), who presented a more detailed definition of system boundaries. Figure 2.4 presents a simplified version of that description based on the chosen depth of analysis.

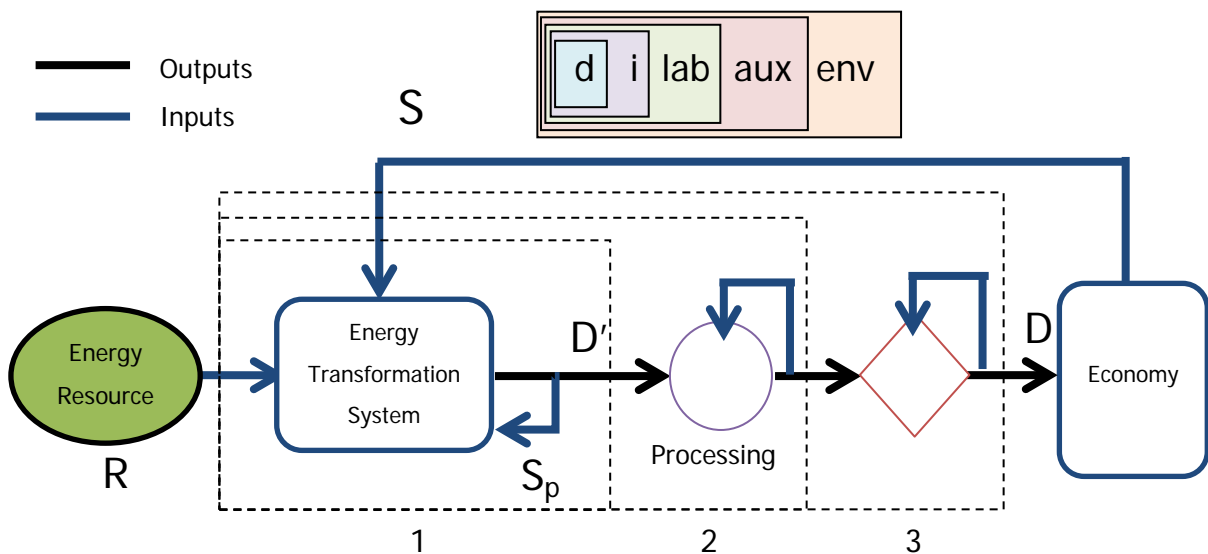

**Figure 2.4: Model of energy - economy system indicating system boundaries for EROI analyses. Adapted from Murphy et al. (Murphy, Hall, Dale, & Cleveland, 2011)**

The designations “d,i,lab,aux and env” represent direct (fuel bought in from the economy), indirect (plant and resource extraction), labour (food and transport), auxiliary and environmental inputs from the economy. The simplest EROI calculations only investigate direct and indirect inputs. The system boundaries ‘1, 2 and 3’ represent the boundary levels extraction, processing and distribution respectively.

(Murphy & Hall, 2010) stated that wider system boundaries lead to lower calculated EROI values, due to the wider scope of energy inputs included. (Murphy et al., 2011) introduced  $EROI_{stnd}$  as a common benchmark to be used across all studies, on top of any other types of EROI values that may be calculated.

$$EROI_{stnd} = EROI_{1,i} = \frac{D'}{S_{1d} + S_{1i}} \quad (2.2)$$

Where  $D'$  in Equation 2.2 represents the energy delivered by the plant to the economy (i.e. net electrical output), not including any processing and distribution losses of that energy (Figure 2.4).



A further analysis,  $EROI_{3,i}$  includes consideration for the processing and distribution costs, such as electrical transportation losses between the plant and end user, as shown in Figure 2.4.

$$EROI_{3,i} = \frac{D}{S_{3d}+S_{3i}} \quad (2.3)$$

Equation 2.3 defines  $EROI_{3,i}$  as the net energy distributed by the system  $D$  (which accounts for  $S_p$  and any distribution and transmission energy investment and losses), divided by the direct ( $S_{3d}$ ) and indirect ( $S_{3i}$ ) energy costs drawn from the economy in order to produce and distribute this energy.

The EROI of a single geothermal power plant is presented as a dynamic function over time in a paper by (Atlason & Unnthorsson, 2013). When EROI is calculated as a dynamic function for a single energy resource, the overall EROI changes over the system's lifetime, as more energy is generated from the resource and further operational costs are incurred. The slope of these curves can be expected to level off with time for most electricity generation processes, as the embodied energy in the initial capital setup of the process becomes a smaller and smaller fraction of the total energy cost/spend.

$$EROI_{1,i}(t) = \frac{\int \dot{D}(t)dt}{\int (\dot{S}_{1d}(t)+\dot{S}_{1i}(t))dt} \quad (2.4)$$

The potential existence of a maximum in this dynamic EROI function indicates if and when operational and resource costs are expected to escalate to a point where an energy profit can no longer be made from the continued running of the existing process. In cases where the annual energy costs of running the plant are constant (i.e. operational and resource costs do not escalate over the lifetime of the plant, as is assumed for all the ORCs in this study), the dynamic EROI of the plant will approach a limit as time approaches infinity. This limit is equal to the EROI of operation for a given plant over a given time period. As the operational costs and benefits of the plant in this analysis are accrued once per year, this EROI is referred to in this paper as  $EROI_{\text{annual}}$ .

$$EROI_{\text{annual},3,i}(n) = \frac{D(n)}{S_{3d}(n)+S_{3i}(n)} \quad (2.5)$$

Where  $n$  represents a specific year of operation.

One aspect of EROI analysis that sometimes varies between studies is whether the energy produced by the cycle that is used in the process (system pumps etc.), is to be included in the numerator or denominator ( $S_p$  in Figures 2.3 and 2.4). As the EROI value sought in this study is from the perspective of energy supplies to and from the economy, the 'investors' view' as described in (Weißbach et al., 2013) is used, where parasitic energy used by the plant is taken from the numerator, giving the output energy delivered to the economy,  $D$  (or  $D'$ ).

### 2.2.2 Study Procedure

The  $EROI_{\text{std}}$  value is calculated for a variety of resource scenarios in this study. Decommissioning energy costs are not included. A wide range of scenarios were chosen to provide EROI estimates that can be used as an indicator for many of the ORC systems currently in use worldwide. The scenarios studied are summarised as follows;

#### Geothermal

- Low temperature geothermal ORC plant using 97°C hot surface water (base case).
- Low temperature geothermal plant using 73°C hot water from a 217 m deep production well.
- Medium-temperature geothermal binary plant using a 230°C resource, production wells with an average depth of 2000 m and a high fluid flow rate.
- Medium-temperature geothermal binary plant using a 230°C resource, production wells with an average depth of 2000 m and a low fluid flow rate.

#### Biomass

- ORC addition to an existing thermal boiler (CHP) with radiata pine woodchips, specifically grown for boiler system, used as a fuel resource. Both 10km and 50km road transportation requirements for the wood chips are considered.
- Power-only biomass electricity generation system (no necessary thermal energy requirement at site) with radiata pine woodchips specifically grown for boiler system used as a fuel resource. Both 10km and 50km road transportation requirements for the wood chips are considered.

#### Solar thermal

- ORC addition to an existing or otherwise necessary solar thermal collector system, based on the average costs of solar thermal systems investigated in Section 1.5.
- Power-only solar thermal electricity generation system (no thermal energy requirement at site), based on the average costs of solar thermal systems investigated in Section 1.5.

#### Waste Heat Recovery (WHR)

- Scenario based on the average costs of the WHR systems investigated in Section 1.5 (average of a range of applications).

A limitation of high-level energy analysis is the availability of energy data. As pricing information is usually more readily available than energy data, a 'top-down' approach was used for most of the energy input assessment. This method estimates the energy embodied in a part or service from its dollar cost by using an energy intensity conversion. This conversion provides an estimated average amount of MJ required per dollar, based on the economic sector on which it is spent.

$$S [MJ] = \$_{\text{investment}} [\$] \cdot e_{\text{investment}} \left[ \frac{MJ}{\$} \right] \quad (2.6)$$

The  $e_{\text{investment}}$  number is the energy intensity of spending within a particular economic sector.

An estimate of appropriate values for energy intensity of spending are obtained using the EIO/LCA online tool by the Green Design Institute at Carnegie Mellon University (US 2002 Industry Benchmark model, 2008). The EIO/LCA tool uses the input-output method to create a database of energy intensities for various industrial sectors within the North American Industrial Classification System (NAICS).

The energy intensities can then be used to find an average ORC energy intensity,  $e_{investment,ORC}$  by weighting the energy intensities with the proportion of the budget spent on each sector (Equation 2.6). As it is difficult to find detailed budget data for commercial ORC systems manufactured in the US, a single 'base case' budget is chosen, where the capital budget is spent in sectors common to all ORC systems. It is assumed that the relative proportion of money spent on each sector in this 'base case' budget is representative for all ORC systems.

$$e_{investment,ORC} = \frac{\sum_{i=1}^n e_{Sector(n)} \cdot \$_{Sector(n)}}{\$_{Total\ investment}} \quad (2.7)$$

The average ORC maintenance energy intensity,  $e_{maintenance,ORC}$ , can be found using a similar method. Fortunately, the chosen base case provides both a detailed plant construction and maintenance budget for the core system.

The 'base case' ORC units chosen for this study are manufactured in the U.S. by United Technologies (UTC Pratt & Whitney, 2009). The most recent available EIO/LCA tool with U.S. 2002 producer values was used. The most relevant NAICS industrial sector was chosen from the available data to estimate the energy intensity of each component of the budget in Table 2.1. The energy intensity figures were adjusted for inflation where necessary by using the U.S. producer price index for each sector, or the closest sector with available data (Bureau of Labor Statistics, 2014) as recommended in (Murphy et al., 2011). Prices quoted in NZD were converted to USD using the exchange rate at the time of quotation.

### **2.2.3 Specific energy of ORC systems - Waikite Valley UTC PureCycle base case**

The base ORC unit, chosen to determine the energy intensity of investment into ORC systems for all scenarios in this study, is a UTC PureCycle genset. United Technologies advertise the PureCycle system as being relatively affordable, with 92% of its hardware being adopted from the existing mass-produced Carrier refrigeration line (UTC Pratt & Whitney, 2009).

The Waikite site was chosen for a base case as it is uniquely situated near electricity infrastructure and utilises a developed hot water source. As a result, the connection of the plant requires negligible power line and hot water piping infrastructure. This is a large potential energy saving, as piping and power line connection accounted for about a third of the total embodied energy in a previous study on the EROI of geothermal power (Atlason & Unnthorsson, 2013). The Waikite site also uses a hot water surface spring at 97°C, and so no geothermal well drilling is necessary for the project. After being used for power generation, the Waikite geothermal water is then cooled to 40°C and used for the nearby Waikite hot pools. The Waikite plant is intended to use R245fa as a working fluid, a low ozone depletion potential (ODP) refrigerant.

While no power plant at the Waikite site has actually been constructed, a feasibility analysis was performed by East Harbour Energy (White, 2009), with funding from the New Zealand government. Prices quoted in the study were in NZD, converted from USD at an exchange rate of 0.62 USD/NZD where applicable. As the budget was presented at the feasibility stage in the project, it has an expected accuracy of  $\pm 30\%$ . The budget breakdown and associated specific energy cost for the corresponding sector is presented in Table 2.1.

**Table 2.1: Capital budget and estimated embodied energy for the proposed Waikite plant. Costs are in 2009 USD. Capital price information from Figure 8 in (White, 2009)**

<b>Plant Capital Cost</b>	Cost (USD Jan 2009)	NAICS Sector Code(s)	Energy (MJ/USD Jan 2009)	Intensity
Planning	\$83,700	541300		2.29
<b>Generation plant</b>	<b>\$649,760</b>			
UTC Genset, cooling tower, spares	\$484,220	333415		6.78
Building incl. foundations	\$58,900	230103		5.80
Pumps, Pipework and balance of plant	\$29,760	333911, 332996*		6.97
Consultancy and project management	\$27,590	541300		2.29
Contingency	\$49,600	Average**		6.49
<b>Electrical connection and controls</b>	<b>\$74,400</b>			
Transformers	\$31,000	33441A		10.39
Wiring/Switchgear	\$15,500	335313		4.71
Consulting Fees	\$6,200	541300		2.29
Controls and Instrumentation	\$6,200	335314		3.82
Contingency	\$15,500	Average**		7.35
<b>Total Capital Budget</b>	<b>\$808,170</b>			
<b>Weighted Average Energy Intensity</b>				<b>6.13 MJ/\$</b>
<b>Total Embodied Energy (GJ)</b>				<b>4955 GJ</b>

\*An average of the energy intensity estimate for each of the two sectors was used

\*\*A weighted average energy intensity of the 'Generation Plant' and 'Electrical connection and controls' section was used for each contingency estimate respectively.

Due to the  $\pm 30\%$  accuracy of the budget components, the upper error limit for energy intensity is 6.49 MJ/\$ and the lower limit is 5.66 MJ/\$. The average energy intensity of money spent on ORC systems without additional infrastructure is therefore estimated as  $6.1 \pm 0.5$  MJ/USD 2009.

A maintenance budget was also provided with the feasibility study. The budgeted annual maintenance cost for Waikite was found to be 6.49% of the initial capital budget per year. The maintenance budget breakdown and associated specific energy cost for the corresponding sector is presented in Table 2.2. It was found that the overall energy intensity (MJ/\$) of maintenance was lower than for the initial capital spending.

**Table 2.2: Expected annual operating costs for Waikite 272kW Binary power plant.**

<b>Operating Costs</b>	Cost (USD Jan 2009)	NAICS Sector Code(s)	Energy Intensity (MJ/USD Jan 2009)
Balance of plant - parts, labour	\$14,880	Average*	6.13
Ancillary systems servicing	\$3,100	Average*	6.13
Routine Service, breakdown attendance and operational support	\$22,078	541300	2.29
Daily fixed charge - electrical connection	\$4,340	335311	6.87
Rates	\$1,860	541300	2.29
Site Rental	\$6,200	541300	2.29
<b>Total Operating Cost / Year</b>	<b>\$52,458</b>		
<b>Weighted Average Energy intensity</b>			<b>3.98 MJ/\$</b>
<b>Total Annual Maintenance Energy</b>			<b>209 GJ/yr</b>

\*The 'Weighted Average Energy Intensity' of the initial plant budget was used as an estimate.

The total energy operating cost (\$) was converted to an energy value (GJ) by using the estimated energy intensities for the US energy industry as outlined in Section 2.2.3. The estimated maintenance energy cost is 209 GJ/yr.

Due to the  $\pm 30\%$  accuracy of the budget components, the upper error limit for energy intensity is 4.17 MJ/\$ and the lower limit is 3.81 MJ/\$. The average energy intensity of money spent on ORC systems without additional infrastructure is therefore estimated as  $4.0 \pm 0.2$  MJ/USD 2009.

#### **2.2.4. EROI of Waikite ORC power plant**

##### ***Power generation at Waikite***

From the feasibility study, the expected gross power output of the UTC 280 unit is 272 kW. Parasitic electricity loads were estimated in the feasibility study to be 27 kW for the working fluid pump, and 26 kW for the fans in the condenser and ancillary pumps to move the hot water. The resulting average net power output is 219 kW. A capacity factor of 92% is used in the feasibility study. The net energy delivered, designated D' in Figure 2.4, is 6358 GJ annually.

##### ***Groundwork and station house***

The expected site for the plant rests at the end of a car park, and so minimal groundwork is expected for the plant.

##### ***Energy transfer system to user***

There are some expected costs associated with the transfer of electricity from the plant to the nearby 11kV power lines; this includes a transformer, wiring and switchgear. It is assumed that the power generation of the Waikite plant contributes negligibly to additional transmission infrastructure requirements on the New Zealand grid.

##### ***Pumping, fans and pipe work***

A low-noise water-cooled cooling tower was used in the study requiring about 4 litres/s of make-up water from a borehole situated in Waikite valley.

##### ***Transportation***

The United Technologies (UTC) Turboden PureCycle 280 modular ORC unit is produced in the US with a shipping weight of 12,519 kg (UTC Pratt & Whitney, 2009).

A reasonable minimum-energy transport pathway was assumed. Shipping of the unit from Houston to the port of Tauranga via Los Angeles was considered. The sea route between these destinations is approximately 18776 km. The typical bunker oil usage for large scale shipping is about 0.00315 kg/km/tonne carried. By using an average energy value for oil of 41.87 GJ/tonne (APS, 2013), the total energy required for the transport was calculated. An estimated 17.3 GJ is needed to transport the materials via ship from Los Angeles to Tauranga.

For road transportation, the unit would have to be transported from a manufacturing facility in San Antonio to Houston, and then from Tauranga to Waikite. The total distance of road transportation is 420 km. Using a typical energy usage figure for road transportation of 2.22 MJ/(km.tonne) (Hall & Klitgaard, 2012); approximately 11.7 GJ was needed to transport the materials by road.

This calculated transportation cost of the ORC unit is negligible, and so the transportation cost of the ORC unit itself is excluded in the analyses of the larger systems studied in Section 2.3.

### *Sum of embodied energy*

The total embodied energy for the plant was calculated as 4998 GJ. With operation and maintenance, this gives an energy payback time of 0.88 years ( $EROI_{1,i}(t = 0.88) = 1$ ).

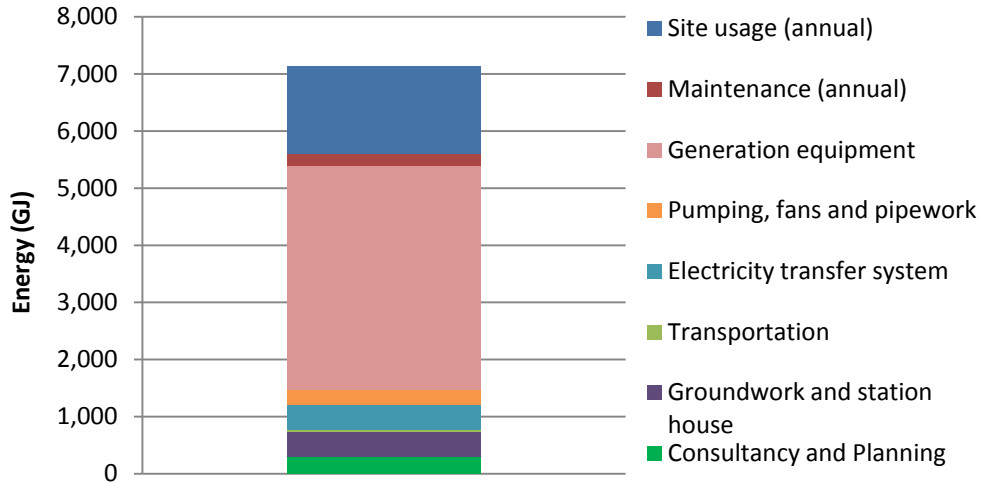

**Figure 2.5: Distribution of embodied energy and energy usage for the Waikite plant after one year of operation.**

### *EROI of Waikite*

The energy input required for processing and distribution processes and infrastructure is included in  $EROI_{3,i}$ , but not  $EROI_{std}$ , as shown in Figure 2.4. The average electricity transmission and distribution losses in NZ were 7.1% in 2009 (MBIE, 2015). Applying these losses to the Waikite plant results in net annual distributed power generation (D in Equation 2.3) of 5907 GJ/yr. With a nominal design lifetime of 20 years (White, 2009), the Waikite plant has an estimated  $EROI_{std}$  of 13.9 with a range derived from the budget error of 11.9 - 16.5. At 20 years, the estimated  $EROI_{3,i}$  is 12.9 with a range of 11.1 - 5.4. The calculated EROI for each additional year of operation,  $EROI_{annual}$ , is constant at 28.3.

**Table 2.3: Calculated  $EROI_{std}$  and  $EROI_{3,i}$  for the proposed Waikite hot springs geothermal plant.**

Year	Output (GJ)	Input (GJ)	$EROI_{std}$	$EROI_{3,i}$
1	6358	5182	$1.2 \pm 0.1$	1.1
10	63581	7063	$9.0 \pm 0.6$	8.4
<b>20</b>	<b>127161</b>	<b>9153</b>	<b><math>13.9 \pm 0.9</math></b>	<b>12.9</b>
30	190742	11243	$17.0 \pm 1.0$	15.8
40	254322	13333	$19.1 \pm 1.1$	17.7



## 2.3 Application of method to other ORC systems

### 2.3.1. Methodology

The basic operating principal of the core mechanical and electrical components in all ORC systems are generally similar (expander, generator, evaporator, pump, and condenser). The analysis performed for the UTC PureCycle ORC in Section 2.2.4 uses budget data to estimate the energy intensity involved in the production of the components, infrastructure, and services necessary to install a basic ORC system. This can be considered a 'base' case, as only a minimal level of ancillary infrastructure is necessary. Most ORC applications require further infrastructure and ongoing services to transform and deliver the chosen resource to the system.

This section estimates the EROI of a variety of ORC applications by applying the 'top-down' cost-to-energy method as described in Section 2.2.3., as well as additional energy costs calculated using 'bottom-up' methods. In order to estimate the EROI of systems where highly detailed budget data is not available, a common assumption throughout these analyses is that the money spent towards the core ORC unit is assumed to have an equal energy intensity as the UTC PureCycle unit of 6.1 MJ/2009 USD. The energy intensity of basic maintenance costs was also assumed to be equal to that of the UTC system, at 4.0 MJ/2009 USD.

### **2.3.2. 410 kW Chena hot springs geothermal system**

The Chena binary geothermal power plant is a unique case that has received much attention in literature. It is frequently noted as the lowest temperature commercial binary power generation plant in the world (Holdmann, 2007a). The plant was built to replace expensive diesel generation in the remote region of Chena, Alaska.

The Chena power plant uses two UTC PureCycle 200 ORC systems with 73°C geothermal water as a heat source and R134a as the working fluid. These units are similar to the PureCycle 280 units investigated in the Waikite study. Compared to the Waikite plant, a large amount of plant infrastructure is needed to be built in a remote location, including drilling of a 217 m production well, a 214 m reinjection well, and an air cooled condenser (ACC). This case study is used to determine the effect that the extra infrastructure and transportation required by Chena (compared to Waikite) has on the EROI of the project. The energy costs of the largely government funded GRED III Phase I resource exploration project, used to inform the well drilling locations at Chena, is not included in this analysis. A third 280 kW unit later installed at the site (Aneke, Agnew, & Underwood, 2011) is also not included in the analysis.

The overall project expenses for the initial Chena plant totalled \$2,007,770 2006 USD (Holdmann, 2007b).

#### ***Power generation at Chena.***

From August 2006 until September 2009, the average gross per unit power output when running was 266 kW (Karl, 2009). The average net output of the plant is 210 kW per unit (Holdmann, 2007a). With a capacity factor of 92%, this gives Chena an estimated annual net energy output of 12194 GJ.

#### ***Energy component calculation***

The Chena project uses similar US-built PureCycle to the Waikite base case, but the plant is remote and so its development required extra transportation of equipment and skilled labour. As a result, the capital cost of the Chena plant is expensive when compared to Waikite.

Chena has a specific capital cost of \$5018 USD/kW<sub>net</sub>, compared to \$3690 USD/ kW<sub>net</sub> budgeted for Waikite (using Jan 2009 prices). Although both sites use similar basic UTC plants, Chena has additional costs associated with the necessary extra equipment, groundwork, transport, labour and a higher labour compensation rate. For comparison, the US labour cost for manufacturing in 2011 was \$35.53 USD, compared to \$23.38 USD for NZ (U. S. Statistics, 2011).

Transport and well drilling is highly energy intensive, whereas labour is not. As a detailed budget for the Chena plant could not be found, it is difficult to properly account for the variation in energy intensity of the Chena project compared to Waikite. The study assumes that the energy intensity of the additional price of the Chena project compared to Waikite can be represented by the U.S.

heavy and energy industry average. An energy-intensity from Murphy et al. (Murphy et al., 2011) of 13.0 MJ/USD in 2009 (corrected for inflation using the U.S. producer price index) is used for the analysis.

The cost of maintenance as a fraction of total initial spending was assumed to be the same as for the Waikite Hot Springs case study, at 6.49% of the initial capital cost annually, resulting in an estimated annual maintenance energy cost of 545 GJ.

The base plant was assumed to be shipped to the site in a single trip. The transportation cost of the plant to the site was calculated with the same energy intensity values for road and rail transport used in Section 2.2.4. The transportation route consists of road transport from San Antonio to Houston, shipping from Houston to Anchorage, and then road transport from Anchorage to Chena. The total transportation energy is estimated to be 89.0 GJ.

The transport of geothermal water from the well to the plant required about 910 m of 8" HDPE pipe to be installed. The reinjection well is located near the power plant building and did not require significant piping. In order to transport cold water to the once-through condenser, 820 m of 16" steel piping was required. All the piping used the Chena project was recycled or reused from other projects in Alaska (Holdmann, 2007b).

As the Chena system is required to be off-grid, the inclusion of a 3MW uninterruptable power supply (UPS) battery system was necessary to supply a consistent voltage. Some modification had to be made to the marginal power distribution structure in order to support the binary power generation modules.

The total embodied energy for the plant is calculated as 16,817 GJ.

### ***EROI of Chena***

With a nominal design lifetime of 20 years (Holdmann, 2007b), the estimated  $EROI_{std}$  of Chena is 8.8. The EROI for each additional year of operation,  $EROI_{annual}$ , is constant at 22.4. The energy payback time is estimated to be 1.44 years ( $EROI_{std}(t = 1.44) = 1$ ).

**Table 2.4: Summary of embodied energy costs of Waikite (NZ) and Chena (Alaska) ORCs.**

<b>Energy</b>	<b>Waikite 219 kW</b>	<b>Chena 420 kW</b>
Embodied energy – UTC ORC unit (GJ)	4955	9503
Embodied energy - Additional infrastructure (GJ)	0	7225
Transportation of unit to site (GJ)	43	89
Annual maintenance (GJ/yr)	209	545
Annual net generation (GJ/yr)	6358	12194
Lifetime (years)	20	20
$EROI_{annual}$	$30.4 \pm 1.4$	$22.4 \pm 1.0$
<b><math>EROI_{std}</math></b>	<b><math>13.9 \pm 0.9</math></b>	<b><math>8.8 \pm 0.6</math></b>

### 2.3.3. SKM NZ geothermal study

An extensive study into the cost of geothermal in New Zealand by SKM provided the basis for the assessment of larger-scale binary plants (SKM, 2009). This study investigates a theoretical binary plant development situated in the Taupo Volcanic Zone (TVZ) with an average production well depth of 2000 meters and a 20 MWe net power output capacity. Two well flow scenarios are specified, high flow and low flow, and separate well number requirements and infrastructure costs are estimated for each.

**Table 2.5: Energy intensity of well drilling in the EIO LCA model.**

Sector	Cost/2000m well (2004 USD)	NAICS Sector Code(s)	Energy Intensity (MJ/USD 2004)
Well drilling	\$2.60 million	213111	10.4

Similar to the Chena geothermal plant, the specific energy of money spent toward the ORC system is assumed to be equal to that of the UTC PureCycle unit proposed for Waikite, at 6.13 MJ/2007 USD. The specific energy cost of maintenance was also assumed to be equal at 3.98 MJ/2007 USD. The specific energy of well drilling was estimated using the EIO LCA database for NAICS sector code 213111 'Oil and gas well drilling' (Table 2.5). The cost of geothermal well drilling was estimated using the WellCost Lite model produced by MIT (Figure A2.1). The specific energy of well drilling is additionally used to compute the ongoing make-up well drilling energy costs.

**Table 2.6: Summary of EROI for large binary geothermal projects in NZ.**

Energy	High Flow	Low Flow
	20 MW	20 MW
Embodied energy- ORC unit (GJ)	231,752	231,752
Embodied energy- establishment and infrastructure (GJ)	98,709	145,918
Initial well drilling (GJ)	108,161	243,361
Operation and maintenance (GJ/yr)	6129	6129
Drilling make-up wells (GJ/yr)	8112	4056
Annual electrical output (GJ/yr)	580,660	580,660
Lifetime (years)	30	30
EROI <sub>annual</sub>	57.0 ± 9.7	40.8 ± 9.5
<b>EROI<sub>std</sub></b>	<b>23.4 ± 3.7</b>	<b>16.6 ± 3.5</b>

#### **2.3.4. Biomass addition to existing boiler (CHP)**

As there are no Biomass-ORC plants in New Zealand, the 1 MWe biomass plant in Lienz, Austria was chosen as a suitable case study for the EROI of ORC power generation from Biomass (Reisenhofer, 2002). An advantage of this example is that it is a CHP application, and so can be evaluated as both a power-only electricity system (with some modification), and as an addition to an existing boiler system. For both of the biomass scenarios included in Sections 2.3.4 and 2.3.5, the biomass resource considered was Radiata pine wood chips from NZ forests, instead of the actual biomass wood resource used in Austria.

The embodied energy of the Lienz plant was evaluated assuming the energy intensity to be equal to that of the UTC PureCycle unit proposed for Waikite. The energy intensity cost of maintenance was also assumed to be equal to that of the UTC PureCycle plant.

The provision of wood-based biomass to the boiler system requires forestry production, which in turn requires a primary fuel input, and so this is included in the evaluation of  $EROI_{\text{std}}$  as an indirect energy input from the economy (Figure 2.4). The average fuel input energy/wood output energy ratio for forestry production in NZ is calculated using data from a variety of sources and is summarised in Table A2.1. The annual energy inflow for the forestry production necessary to support a biomass system such as Lienz with 15% thermal efficiency was found to be equal to  $3.6\% \pm 1.8\%$  of the energy produced by the ORC system, mostly in the form of diesel.

The transportation of the biomass is a potentially significant ongoing energy cost, depending on the required distance and transportation mode. Two scenarios were considered, 10 km and 50 km average transportation distances using heavy road transport. The transport vehicle fuel economy was assumed to be equal to the average for the 2010 U.S. fleet of logging trucks (Schlömer S., 2014). The Lienz CHP plant is reported to require 40,000 tonnes of biomass fuel annually (Reisenhofer, 2002). The estimated energy cost of this transportation is equal to 2.0% of the energy produced by the ORC plant for 10km transport, and a significant 10.2% of the energy produced for a 50km transport distance.

Biomass ORC systems applied to an existing or otherwise necessary biomass thermal energy system, such as district heating or industrial steam generation, can provide greater exergetic efficiency and thermal utilisation than a power-only electricity generation system, but at the cost of a slightly reduced net electrical output (Fiaschi, Lifshitz, Manfrida, & Tempesti, 2014). In order to fairly account for the existing necessity for a thermal fuel boiler in this scenario, only the biomass necessary to provide thermal energy above what would be required by an equivalent biomass fuel boiler without an attached ORC is included as energy input, i.e. only a fraction of the CHP system's forestry and transportation energy costs are accounted as energy inputs to the ORC electricity generation system. In the case of the plant at Lienz, an additional 23.5% thermal energy is needed to facilitate electricity generation as well as heat production.

**Table 2.7: Summary of EROI for the electrical component of 1MWe Biomass CHP project**

<b>Energy</b>	<b>CHP plant 10 km from fuel source</b>	<b>CHP plant 50 km from fuel source</b>
Embodied energy – ORC unit (GJ)	21,561	21,561
Embodied energy – additional infrastructure (GJ)	0	0
Consumables (GJ/yr)	42	42
Operation and maintenance (GJ/yr)	280	280
Annual forestry energy (GJ/yr)	213	213
Annual transportation energy (GJ/yr)	121	607
Annual electrical output (GJ/yr)	25,200	25,200
Lifetime (years)	20	20
EROI <sub>annual</sub>	38.4 ± 8.6	22.0 ± 2.6
<b>EROI<sub>std</sub></b>	<b>14.5 ± 1.9</b>	<b>11.4 ± 1.1</b>

### 2.3.5 Biomass power-only system

A well-designed power-only biomass electricity system can provide a greater net electrical output than a CHP plant for a given thermal input, but at the cost of far less of the available heat energy being utilised (Bini, 2010; Fiaschi et al., 2014). A theoretical biomass system was investigated using the Lienz plant as an example, with several changes to represent a power-only electricity system instead of the CHP-ORC system investigated in Section 2.3.4;

- The full embodied energy cost of both the boilers and the ORC system were included as an energy input.
- The net electrical output of the ORC system was changed to 1.33 MW (20% system electrical efficiency), instead of the original 1 MW (15% electrical efficiency), to account for the greater proportion of heat transferred to the working fluid in power-only ORC plant (Bini, 2010).
- The full cost of acquiring and transporting the biomass was included as an ongoing energy input, as opposed to only the proportion required to supply the additional electricity generation, as used in Section 2.3.4.
- The full energy cost of operating and maintaining the boiler was included as an ongoing energy input.

The net result of these changes is a less favourable EROI than found in the CHP system, as the full cost of growing and harvesting the biomass resource is attributable solely to ORC electricity generation, and so included in full as an energy input. Similar to the CHP-ORC system, the EROI of power-only electricity generation is also highly dependent on the transport requirements for the Biomass resource. The EROI of the biomass ORC electricity-only systems investigated are summarised in Table 2.8.

**Table 2.8: Summary of EROI for the electrical component of 1.33MWe Biomass power-only electricity project**

Energy	CHP plant 10 km from fuel source	CHP plant 50 km from fuel source
Embodied energy – ORC unit (GJ)	21,561	21,561
Embodied energy – additional infrastructure (GJ)	10,781	10,781
Consumables (GJ/yr)	63	63
Operation and maintenance (GJ/yr)	420	420
Annual forestry energy (GJ/yr)	904	904
Annual transportation energy (GJ/yr)	516	2,578
Annual electrical output (GJ/yr)	32,341	32,341
Lifetime (years)	20	20
EROI <sub>annual</sub>	17.7 ± 5.8	8.5 ± 1.1
<b>EROI<sub>std</sub></b>	<b>9.5 ± 2.0</b>	<b>6.0 ± 1.5</b>

Tables 2.7 and 2.8 exemplify the strong dependency that the EROI of biomass ORCs has on the distance between the fuel source and the power generation system. This implies that large diesel-based road transport requirements, in the order of >600km will nullify a biomass ORC electricity system as a primary energy source, as it then requires energy subsidies from fossil fuels greater than the electrical energy output energy.

A greater EROI may be achieved by a system that uses a waste-wood biomass resource, as the energy cost component due to forestry would be greatly reduced. It was found that any biomass ORC plant, waste-wood or new fuel, must be positioned close to the resource location or an efficient transport solution, such as rail or shipping, in order to provide a strong EROI. Road transport energy requirements quickly outstrip the forestry energy requirements and become the dominant ongoing energy cost for a biomass system at distances greater than 20km.



### 2.3.6. Solar thermal ORC system

The EROI of two hypothetical solar thermal ORC systems are evaluated using theoretical systems based on the average of the solar-thermal (direct collection and CSP) case studies surveyed in Section 1.5. No solar thermal ORC systems are currently based in New Zealand; the examples used here in order to model the theoretical system are based in Italy, Germany and South Korea. The average size of the four solar thermal systems surveyed was 0.5 MW.

The two solar thermal systems evaluated are a power-only application for electricity generation (1), and a solar-CHP solution (2);

1. For the theoretical power-only electricity system, the full energy cost involved in producing and maintaining the solar collectors, as well as the ORC system are included as energy inputs. This scenario is also relevant for solar reverse-osmosis systems (Schuster, Karellas, Kakaras, & Spliethoff, 2009).
2. Similar to the biomass CHP system, the EROI evaluation of the solar CHP system includes the full energy costs involved with producing and maintaining the ORC system, but not of producing and maintaining the solar collectors. Instead, only the energy costs related to the production and maintenance of the solar thermal collectors above what would be required for an equivalent thermal-only system are included. This assumes that the thermal collectors are already existing or necessary, which is possibly less likely in the case of solar than for biomass. Analysis of the solar-thermal system in (Jradi & Riffat, 2014) indicates that for a low-temperature solar thermal system, approximately 40% additional thermal energy is required in order to facilitate electricity production when compared to a thermal-only plant.

Once again, of the two solutions, the solar-CHP plant provided a greater EROI. Both solar solutions provide an EROI lower than the biomass and geothermal resource scenarios investigated in this study. The energy inputs and outputs in Table 2.9 are listed on a per kW capacity basis, as the theoretical system was normalised to a specific (\$/kW) cost bases.

**Table 2.9: Energy costs per kWe and EROI for theoretical solar electricity and solar CHP systems.**

Energy	Solar thermal-CHP ORC	Electricity-only solar thermal ORC
Embodied energy – ORC unit (GJ/kWe)	17.0	17.0
Embodied energy – solar collectors (GJ/kWe)	9.5	23.6
Operation and maintenance (GJ/kWe.yr)	0.5	0.8
Annual electrical output (GJ/kWe.yr)	9.5	9.5
Lifetime (years)	20.0	20.0
EROI <sub>annual</sub>	19.2 ± 0.9	12.5 ± 0.6
<b>EROI<sub>stnd</sub></b>	<b>5.2 ± 0.4</b>	<b>3.4 ± 0.2</b>

### 2.3.7. Waste heat ORC system

The EROI of waste heat ORC systems is evaluated using a theoretical system based on the average of the WHR ORC systems surveyed in Section 1.5. The initial capital and ongoing maintenance energy costs are estimated using the same energy intensity as the UTC PureCycle system proposed for Waikite. The base data is largely from case studies provided by Turboden in an industrial magazine (Vescovo, 2009), and so may be presenting a best-case scenario. The average size of the ten WHR systems surveyed was 1.5 MW.

**Table 2.10: Energy costs per kWe capacity and EROI for theoretical WHR ORC system.**

<b>Energy</b>	<b>WHR survey average</b>
Embodied energy – ORC unit (GJ/kWe)	26.3
Operation and maintenance (GJ/kWe.yr)	0.4
Annual electrical output (GJ/kWe.yr)	28.4
Lifetime (years)	15.0
EROI <sub>annual</sub>	72.4 ± 3.2
<b>EROI<sub>std</sub></b>	<b>13.3 ± 1.0</b>

## 2.4 Analysis of results

### 2.4.1. Results summary

**Table 2.11: Summary of estimated lifetime EROI<sub>stnd</sub> and EROI<sub>annual</sub> of electricity generation from various resources using ORC technology. Geothermal and WHR systems considered are power-only systems for the sole purpose of electricity generation. Biomass and solar thermal systems considered are either power-only or in addition to existing or necessary heating infrastructure.**

Resource	Description	Size (MW)	EROI <sub>stnd</sub>	EROI <sub>annual</sub>
Geothermal	Surface water 99°C, 210 kW	0.22	13.9	30.4
Geothermal	217 m deep 73°C	0.42	8.8	22.4
Geothermal	2000 m deep, 230°C, low flow	20	15.9	40.8
Geothermal	2000 m deep, 230°C, high flow	20	22.7	57.0
<b>Geothermal</b>	<b>Mean</b>		<b>15.7</b>	
Biomass	Electricity only 10km by road from resource	1	9.5	17.7
Biomass	Electricity only 50km by road from resource	1	6.0	8.5
Biomass	Addition to existing boiler system (CHP) 10km	1	14.5	38.4
Biomass	Addition to existing boiler system (CHP) 50km	1	11.4	22.1
<b>Biomass</b>	<b>Mean</b>		<b>10.4</b>	
WHR	Survey average	1.5	13.3	72.4
<b>WHR</b>	<b>Mean</b>		<b>13.3</b>	
Solar thermal	Survey average – System for electricity only	0.5	3.4	12.5
Solar thermal	Survey average – ORC addition (CHP)	0.5	5.2	19.2
<b>Solar thermal</b>	<b>Mean</b>		<b>4.7</b>	

The results in Table 2.11 indicate that, similar to their economic return on investment (ROI), ORC systems have a wide range of EROI values depending on the type of resource used. Of the scenarios investigated, the system that provided the best EROI was a large-scale geothermal system using a favourable high-flow water resource. The lowest EROI value was found to be from the theoretical electricity-only ORC scenario using solar thermal collectors.

## 2.4.2 Comparison of EROIs for ORC systems

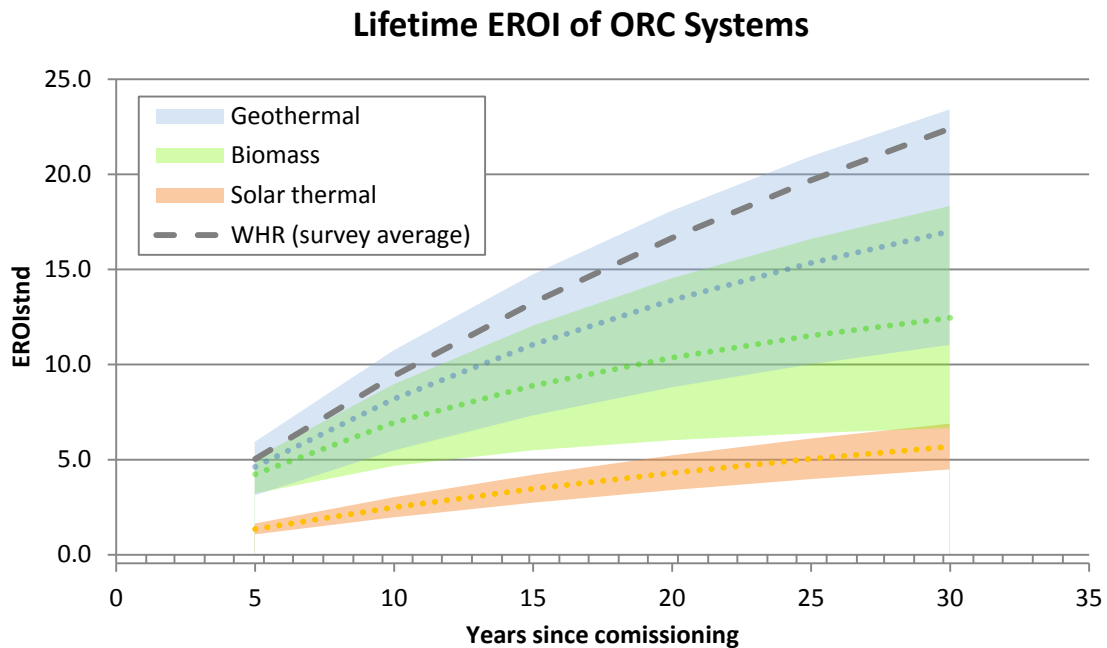

**Figure 2.6: Range of dynamic EROI values for ORC systems operating from various resources. Ranges shown indicate the scenarios investigated in Section 2.3.**

The wide range of EROI values shown in Figure 2.6 indicates that resource availability can have a significant effect on the EROI;

- In general, geothermal systems have the most favourable EROI, with a range of end of lifetime EROI values between 8.8 and 23.4.
- Biomass systems are the next most favourable, with a range from 6.0 to 14.5, although they may have a lower EROI than what is indicated in Figure 2.6, if a significant amount of transport is required for the fuel.
- The single theoretical scenario investigated for WHR systems (grey in Figure 2.6) indicated a strong EROI, but as this is largely based on data from an industrial magazine and not a peer-reviewed source, this result should be compared to further examples based on other datasets once they become available.
- Solar thermal systems indicate that this resource provides the lowest potential EROI of the resources investigated.

The operational  $EROI_{\text{annual}}$  values listed in Table 2.11 can be used to indicate resources that may eventually generate a high EROI, if they can be designed in such a way as to not require a significant increase in annual maintenance costs over a long lifetime. i.e., despite having the lowest  $EROI_{\text{std}}$  of the systems evaluated, the  $EROI_{\text{annual}}$  value of the solar thermal systems is moderately high. A solar thermal CHP system could start to surpass the EROI of biomass systems after 30 years of operation, providing that it can be run without a significant escalation in maintenance costs towards the end of its life.

In order to clearly illustrate an energy cost component breakdown, the Energy Input Fraction (EIF) metric is proposed. This metric is the summation of the lifetime energy cost of each energy cost component, divided by the lifetime electricity production. As a result, the total EIF is equal to the inverse of the EROI. A similar metric called the 'energy intensity' has been used in other analyses (Olivier Vidal, 2014);

$$\text{EIF}(n) = \frac{1}{\text{EROI}} = \frac{\sum_{i=1}^n \text{energy costs}(i)}{\sum_{i=1}^n \text{energy costs}(i)} = \frac{S_{1d} + S_{1i}}{D'} \quad (2.8)$$

Where  $n$  is the lifetime of the project.  $D'$  is the energy delivered before electrical transmission and  $S_{1d} + S_{1i}$  are the direct and indirect energy supplies to the system respectively.

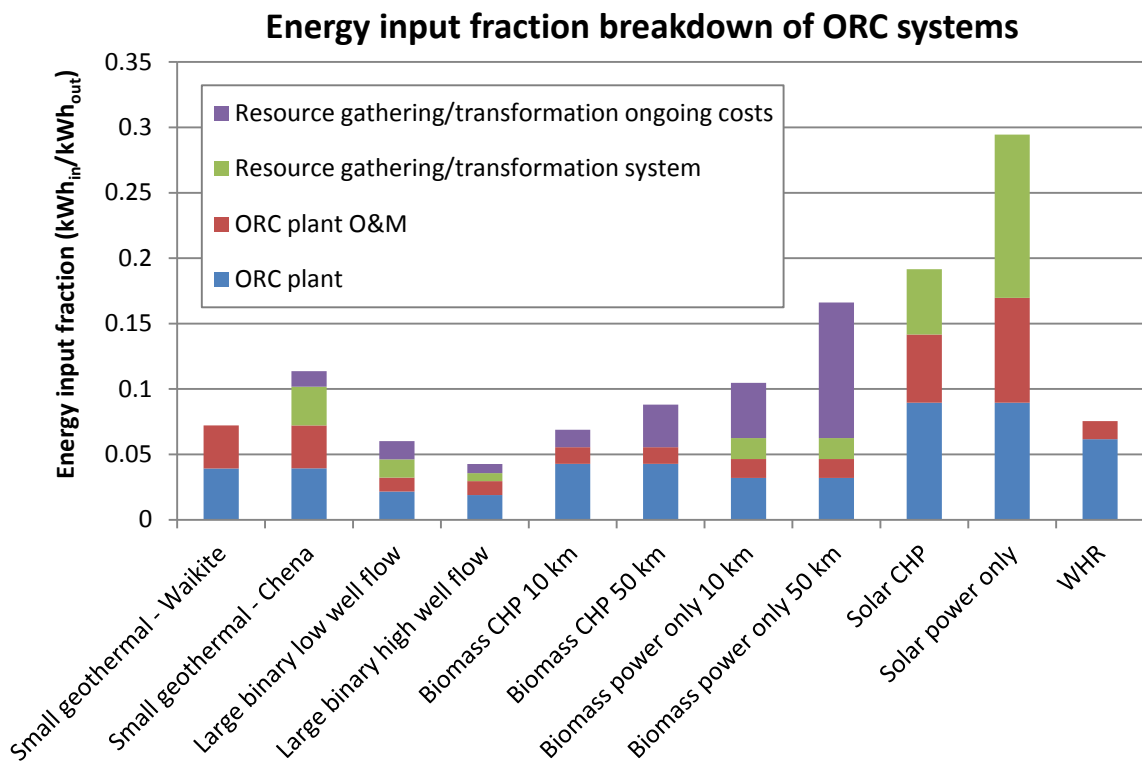

**Figure 2.7: Breakdown of energy input fraction for ORC systems operating from various resources.**

The extent to which the different categories of energy spending contribute to the overall energy cost is shown in Figure 2.7. From the Figure, the WHR and geothermal systems are characterised by moderate plant and O&M costs, and small or negligible resource gathering costs. The biomass plants have similar plant costs, and much more significant annual resource input energy costs. The solar plants do not have ongoing resource accumulation costs, but require a large initial investment in the resource gathering system relative to their overall power outputs.

Given that the EROI required for growth is in the 5-9 range and taking its inverse (C. Hall et al., 2009; J. G. Lambert et al., 2014), a corresponding EIF range below about 0.1 - 0.2 can be considered to be the threshold region for primary energy systems to be able to support net societal growth.

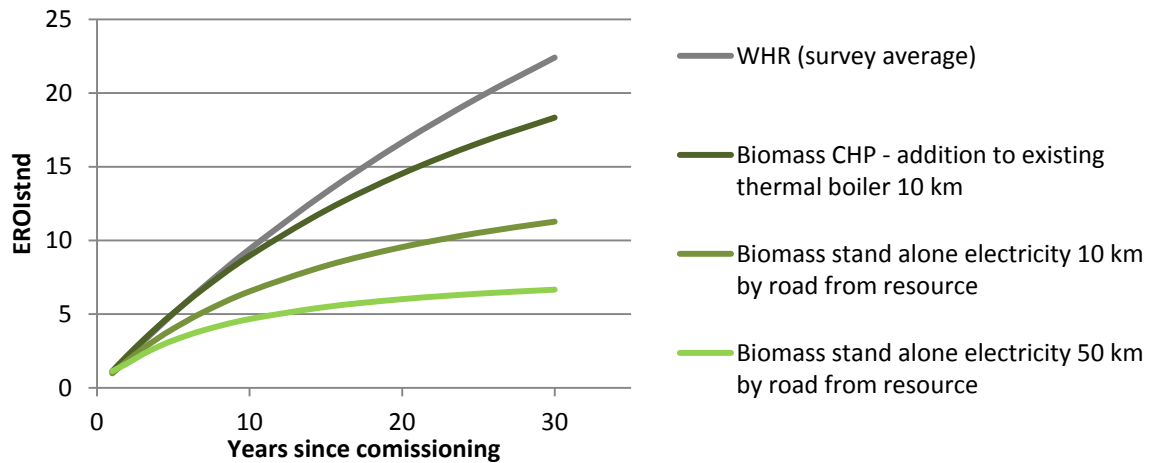

**Figure 2.8: Selected dynamic EROI curves for biomass and WHR resources.**

Figure 2.8 shows that the dynamic  $EROI_{std}$  of a plant most quickly increases during the first years of operation, and grows slower when energy invested into on-going maintenance and resource collection becomes a large proportion of the overall lifetime energy cost. This is especially apparent for systems where annual energy costs bought in from the economy are large in comparison to the annual energy output. The WHR system has an annual energy input of 1.4% of its energy output, or an  $EROI_{annual}$  value of 72.4, resulting in a straighter curve in Figure 2.8. The biomass power-only electricity system with a 50 km resource trucking distance requires the equivalent to 11.8% of its annual energy output as energy input, mostly in the form of diesel, and so its dynamic EROI curve more quickly levels off with time as it approaches asymptote at  $EROI_{annual}$  of 8.5.

Investment into renewable electricity systems is typically more capital intensive, but with lower operational costs than fossil (or ongoing fossil-dependant such as biomass) electricity (C. King, 2013). This cost distribution results in a more linear EROI curve for renewable electricity plants, such as the WHR system in Figure 2.8, than a comparable fossil-based generation system (i.e. one that achieves an identical EROI in a given timeframe). A system with a more linear dynamic EROI curve will perform relatively poorly when assessed with investment criteria that account for the time value of money (NPV, ROI etc.), as it implies that a large fraction of the lifetime outgoing costs will be paid for before the system starts to produce a positive net return.

### 2.4.3. Comparison of ORCs with other technologies

The EROI of ORC systems are compared with other electricity technologies in Figure 2.9.

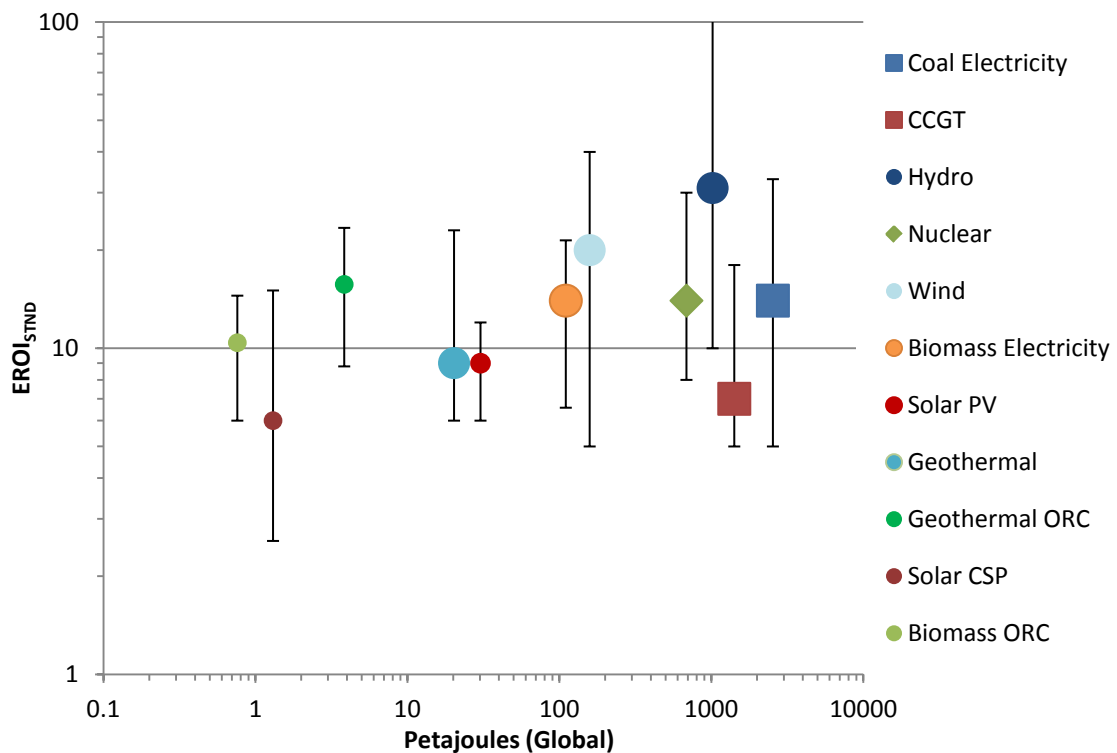

**Figure 2.9: EROI of various electricity sources vs. global usage. Energy usage data for 2012 from (IEA, 2014b), Enertime SA (Enertime, 2012) and own study. EROI values and standard error for technologies other than ORC from Dale, 2010 (Dale, 2010) and Lambert et. al, 2012 (J. H. Lambert, C.; Balogh, S.; Poisson, A.; Gupta, A, 2013). Renewable technologies are indicated with circle markers.**

Figure 2.9 indicates that resources that can produce a high EROI over their lifetime are favoured for mainstream electricity generation. Hydro generation is currently the only renewable resource that produces a globally significant amount of electricity, with geothermal a far second. Nuclear energy, which is also a significant energy resource that can arguably be considered renewable under some circumstances, has a similar EROI to that of binary geothermal plants.

For geothermal resources, ORCs are positioned as a next step technology for utilising flows that are at low temperatures uneconomical for use in a steam cycle. The materials and processes in an ORC cycle are similar to that of a steam system, although a larger investment in materials is generally required for a given power output than steam plants, which usually operate from higher temperature resources (NREL, 2012). As a result of their utilisation the next most economic available resources, geothermal ORC plants may be expected have an average EROI close to, but just below that of traditional steam geothermal and biomass systems. This does not appear to be the case in Figure 2.9, as the geothermal ORC systems exhibit a slightly higher average EROI than their steam counterparts, although this is within the variation of EROI studies.

For biomass systems, ORC technology is advertised as providing lower operating costs and better economics for small cycles due to fewer required components. The EROI of the Lienz plant scenarios investigated is very similar to the of larger biomass systems in Figure 2.9. Biomass ORC systems currently represent a much smaller (roughly 1/100<sup>th</sup>) overall capacity than steam biomass generation.

As mentioned in the introduction to this Chapter, if a societal energy system has an overall EROI below 5-9, that society will not be able to grow (C. Hall et al., 2009; J. G. Lambert et al., 2014). Where their EROI has been studied, modern electricity technologies appear to be able to facilitate EROIs above 5-9 in the situations which they are currently applied, at least in most scenarios (Figure 2.9). The findings of this study indicate that this is also true for biomass, geothermal and WHR-ORCs, but not for solar thermal ORC applications.

In the case of biomass, the situations in which a system may achieve a high EROI value are strongly limited by the distance between the biomass resource and the plant. This result may work in favour of ORC-biomass systems compared to steam systems, as they are economic at a smaller scale, and therefore may be spread over a wider geographical area, although this is also true for biomass-gasification plants. Further study could compare the EROI of smaller, distributed biomass power generation systems with a larger centralised system under variety of generation technologies.



## 2.5 Conclusions from EROI study

In this chapter, the  $EROI_{std}$  of several real and theoretical ORC systems operating from various heat resource scenarios were calculated. These EROI values were determined using a combination of top-down and bottom-up approaches. Top-down energy analysis was undertaken by determining the specific energy (MJ/\$) costs for capital and maintenance expenditure and applying this to system budgets. Bottom-up energy analysis was undertaken using available energy-related data specific to the acquisition of ORC resources.

Lifetime  $EROI_{std}$  values of ranging from 8.8 – 22.7 were calculated for geothermal (binary cycle) ORC applications, 6.0 – 14.5 for biomass ORC applications, 3.4 – 5.2 for solar thermal collection ORC systems, and 13.3 for a single theoretical WHR ORC system. The sizeable difference in EROI between systems using the same type of resource indicates that for these renewable energy systems, the accessibility and quality of the energy resource can strongly affect its energy return. This is especially true for distributed generation systems, as they can face a wide variety of resource quality and existing infrastructure arrangements.

For both the biomass and the solar thermal scenarios investigated, systems that utilised existing or otherwise necessary heating infrastructure produced a higher EROI value than their counterparts which did not. This is particularly true for biomass systems, which achieved EROIs over 5 units greater than their power-only counterparts. This was found to be for two reasons; firstly because the thermal input to these systems use the high enthalpy portion of the resource for electricity generation, while the lower enthalpy portion for heat production, resulting in greater thermal and exergetic efficiency when compared to electricity-only designs, and secondly because a large fraction of the costs associated with resource collection can then be attributed to providing the thermal output, as opposed to solely being for the electrical output.

For the geothermal scenarios investigated, the best EROIs were achieved by large-scale systems operating from higher-temperature resources. This indicates that for ORCs, large, centralised electricity generation developments are favourable where existing electricity transportation infrastructure allows it. The large  $EROI_{annual}$  values of the smaller, distributed generation systems however show that, given a long enough lifetime without major maintenance (40+ years), a distributed geothermal system could provide a greater EROI than larger systems. In general, very high EROIs could be achieved by renewable technologies that have a long lifetime and a low maintenance and operation costs, as indicated by Equation 2.5.

## Chapter 3 – Economic ORC cycle design

---

The economics of ORC system designs are unique, as the costs vary widely depending on the resources to which they are applied, as well as specific system design aspects, such as the selected working fluid. As a relatively new technology, the economically optimal component and design choices for ORCs are not always clear. This chapter provides guidelines for assessing the costs associated with ORC systems. It then uses those guidelines and system models to provide recommendations and optimal solutions for the economic design of specific ORC components. This practise, sometimes called thermo-economic analysis, is then assessed as whole, and related back to EROI and the disparity between economic and energy optimums.

### 3.1 Cost estimation process for ORC technologies

The ORC budget in Section 2.2.3 shows that the core ORC equipment – heat exchangers, turbine, pumps, generator, and cooling equipment – constitute a fraction of the overall ORC investment (Figure 2.5 and Table 2.1). Additional costs to make up the final capital price of an ORC system may come from resource gathering equipment, such as a geothermal steam field, and additional non-equipment costs such as site works, design and transportation (Section 1.3.3).

In ORC analyses, the initial capital costs of the system are usually grouped into the following categories (Gerold Thek, 2004);

$$\text{Plant Capital Cost} = C + A + R \quad (3.1)$$

Where;

- $C$  represents the core component cost
- $A$  is the additional and non-equipment cost
- $R$  is the resource-specific equipment cost

And the ongoing costs as follows;

$$\text{Plant Ongoing Cost} = O + M + F \quad (3.2)$$

- $O$  represents the annual cost of operation
- $M$  is the annual cost of maintenance
- $F$  is the annual fuel cost (negligible for ORCs, except in biomass systems)

### 3.1.1. Core component costs

If common equipment types are used for an ORC design, then the core component costs can be estimated using a scaling cost formula method. These formulas estimate the price based on physical aspects of the design such as size and material. Formulas for the most common ORC components, adapted from (Gerrard, 2000) and (Couper, Penney, Fair, & Walas, 2010) to 2014 NZD, are listed in Table A3.1. The component cost estimates given are for the installed price. Cost formulas such as these are often used for pre-feasibility costing and academic studies and typically have an accuracy of  $\pm 30\%$ .

$$C = \sum_{i=1}^n \text{Core component}(i) \quad (3.3)$$

### 3.1.2. Additional and non-equipment costs

The additional costs include consultancy, planning, contingency, additional equipment, civil installation, controls, heat transportation and any other capital costs associated with an ORC installation, apart from the core system components. As these costs are not calculated explicitly in the ORC design process, it can be useful to represent these costs as a fraction of the core equipment cost;

$$A = yC \quad (3.4)$$

Where  $y$  is the additional cost factor.

While the additional costs are specific to each ORC system, a study of the six real-world ORCs included the economic survey in Section 1.5 indicates that these costs roughly vary as a function of system size. The six 'real-world' systems were grouped into two categories;

- Lower bound systems or 'easy' installations. There are the additional cost factors for the systems included in the survey that require minimal additional infrastructure, and the resource is readily available from a plant engineering perspective.
- Upper bound or 'hard' installations. These are the additional cost factors of systems that require large additional installation costs. These systems can be typified by installation in a remote location, significant steamfield piping, high engineering requirements for cooling water and reinjection pumping, and the necessity for additional treatment systems for one, or all of the fluids.

The upper and lower bounds represent the average for the 'hard' and 'easy' projects surveyed respectively. Most systems can be expected to cost somewhere between these two bounds, but unusually difficult or straightforward projects will fall outside of these bounds. The ORC case studies examined in order to determine an appropriate range for the lower and upper bound system costs were from reports by; (White, 2009), (Holdmann, 2007), (Reisenhofer, 2002), (Nazif, 2011; Vescovo, 2009) and (SKM, 2009). Geothermal, WHR and biomass resources were grouped together to form the estimates, as there was not a sufficient number of detailed studies available to separate each resource.

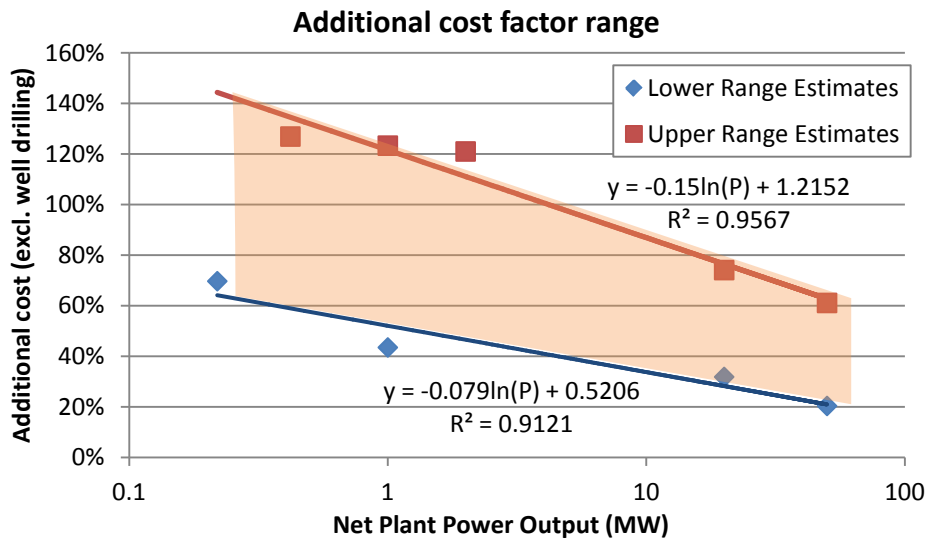

Figure 3.1: Estimates for the additional cost of 'easy' and 'hard' plant installations from case studies. The 'P' in the equations shown represent the net plant power output in MW.

$$-0.079\ln(P) + 0.5206 < y \leq -0.15\ln(P) + 1.2152 \quad (3.5)$$

Where  $P$  is the net plant output power in MW.

Using Figure 3.1 as a guideline, the exact choice of additional cost factor,  $y$ , is best chosen based on a qualitative assessment of the project type and environment.

### **3.1.3. Resource-specific equipment costs**

These costs are specific to the resource collection system, and to an extent can be included in the additional cost factor. Significant resource-specific costs will fall outside these bounds however, and so a more accurate price estimate can be obtained through calculating their cost separately.

#### ***Geothermal steamfield***

A study by (SKM, 2009) estimated geothermal steamfield costs in New Zealand to be between \$650 - \$1850 2014 NZD/kW for 50 MW systems. Smaller systems were assumed to come with a lower amount of risk, such that a 20 MW geothermal field and plant had a narrower price range between \$1100 - \$1200 NZD/kW.

#### ***Biomass boiler***

No sources could be found for biomass boiler costs specifically in New Zealand. In an IEA report by (Gerold Thek, 2004) on the Lienz ORC system in Austria, the boilers were found to have a price of \$1146/kWth, resulting in a specific electricity cost in terms of ORC capacity of \$5170/kWe (2014 NZD).

#### ***Solar thermal collector***

Again, no sources were found for solar thermal collector costs for ORC systems in New Zealand. A recent study by (Mario Veroli, 2014) includes estimates for the resource collection costs for a medium-temperature (200°C – 300°C) 1 MWe and a low temperature (100°C – 150°C) 10 kW solar thermal ORC system. The study found that the cheaper costs of low-temperature collectors were counteracted by the lower generation efficiency obtainable from the ORC system when compared to the medium-temperature collectors. This resulted in the specific costs for both low and medium temperature collectors being about equal in the study, at around \$3200 / kWe ORC output capacity (2014 NZD).

### 3.1.4. Annual maintenance costs

The annual maintenance cost for an individual plant can vary significantly, with estimates from the economic studies surveyed indicating a range of 1%-7%, depending on plant design and resource utilised (Table A1.2 part 2). Similar to the additional cost factor, the maintenance costs can be expected to be partially affected by economies of scale.

The maintenance cost factor is usually indicated as a proportion of the total plant capital cost;

$$M = z(C + A + R) \quad (3.6)$$

Where;

$M$  is the expected annual maintenance cost

$z$  is the annual maintenance cost factor

$C + A + R$  are the plant capital costs from Equation 3.1.

Using the real-case biomass and geothermal studies from section 3.1.2, a rough relationship between annual maintenance cost factor and plant size is estimated;

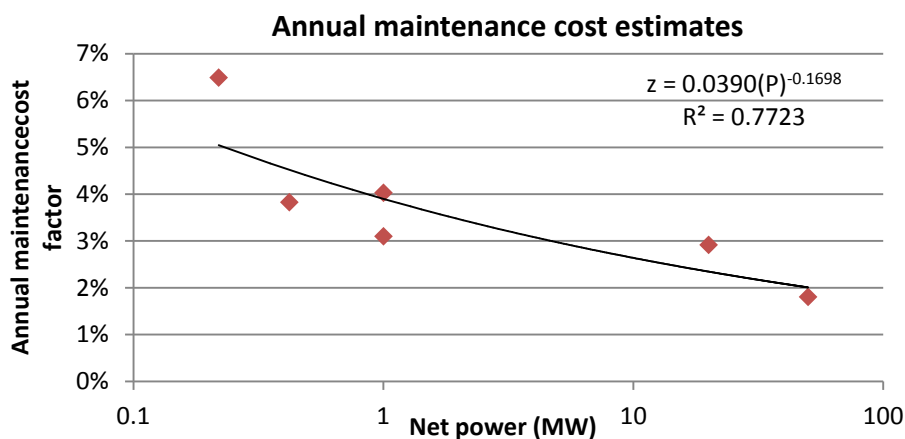

**Figure 3.2: Annual maintenance cost as a percentage of core equipment capital cost for six case study plants. A power function trend line has been added.**

The power relationship in Figure 3.2 gives an estimate of the maintenance cost factor as a function of plant size to be;

$$z = 0.039P^{-0.1698} \quad (3.7)$$

Where  $P$  is the net plant power output in MW.

### **3.1.5. Annual Operating costs**

There is a large potential for operating cost variability between ORC systems; in the economic studies surveyed in Section 1.5.2., the operating cost factor ranges from 0 – 4% of the capital cost annually.

If a full time operator is reimbursed at New Zealand prices of \$25/hr (Careers, May 2014), and the average electricity sales price is 8c/kWh (Figure 1.6), then a system under full-time attendance would require the spot market sales profit from roughly 315 kW of net generation capacity to pay the operator costs. As a result of this cost magnitude, smaller distributed ORC plants must be designed for part-time, centralised, or automated operation (Reshef Ran., 2012).

The cost of remote operation is roughly included in the maintenance cost factor, with the extra instrumentation required included in the additional cost factor. Larger plants may have more extensive operation requirements, and so the operation costs should be calculated directly from an estimate of the expected number and pay grade of the required personnel.

For applications with a boiler, such as a biomass plant, the operating costs also depend on the high side pressure. This is investigated further in Section 3.2.2.

## 3.2. High-side and low-side pressure

The 'high-side' (HP) refers to the components that are exposed to the maximum pressure of the cycle; pump, evaporator, and turbine. While higher operating pressures can provide potential economic advantages by reducing component size and improving heat transfer, high pressure requirements can also act to increase the cost of an ORC system through more expensive components and fittings, or stricter safety requirements. The 'low-side' (LP) refers to the components that are not exposed to high pressures.

In general, high pressure and temperature requirements can be included in pre-feasibility level evaluations using a 'Lang factor' (Gerrard, 2000). Similar to the pressure and Material factors in Tables A3.2 and A3.3, these factors can increase the assumed cost of high temperature or high pressure systems. These factors are designed for the evaluation of large process equipment, and may not accurately represent the scenario for smaller systems. Specific cases of high pressure component requirements and how they may impact the ORC price are given in this section.

### 3.2.1. Turbines in high-pressure cycles

**Table 3.1: Minimum turbine material requirements to meet ISO standard 14661:2000(E) Thermal turbines for industrial applications clause 6.2.2. Casings – Materials (ISO, 2000)**

Max Pressure	Temperatures	Required Casing Material
25 bar	>352 °C	Steel
5-25 bar	262 – 352°C	Nodular cast iron or welded steel
5 bar	7-262°C	Lamellar graphite cast iron, nodular cast iron or steel
None	<7°C	Steel

Table 3.1 indicates that more expensive steel will be required for the turbine casing at pressures above 25 bar. Assuming that the material factor for turbines is similar to that of pump in Table A3.3, a switch from nodular cast iron to carbon steel can be expected to increase the turbine cost by 28%.



### 3.2.2. Biomass Boiler

Similar to turbine systems, boiler systems can face various minimum requirements depending on their operating pressure. One advantage of a biomass ORC system over a steam-based system is that it may use a low-pressure thermal oil boiler, as opposed to a high-pressure steam boiler, to reduce supervision requirements (Reisenhofer, 2002). Another option is to feed the working fluid into the boiler directly, to reduce the number of heat transfer components necessary for the cycle. This however may lead to increased supervision requirements, if a high-pressure ORC cycle is used.

#### *NZ biomass scenario – operator cost*

The Department of Labour Occupational Safety and Health service publishes and enforces boiler operation requirements in New Zealand. A summary of the operation types for shell type boilers is shown in Table 3.2 (Chetwin, 2005). Full details are included Table A3.4 in the Appendix.

**Table 3.2: Summary of range of operating conditions and supervision requirements for shell-type boilers. Adapted from (Chetwin, 2005)**

Category	Heat Capacity	Max. Pressure	Operator type	Check Frequency
<b>Attended Operation</b>	> 20 MW	None	Qualified Operator	Continuous*
<b>Attended operation</b>	> 6 MW	17 Bar	Qualified Operator	Continuous
<b>Limited attendance</b>	< 6 MW	17 Bar	Qualified Operator	8 hour intervals
<b>Unattended</b>	< 6 MW	17 Bar	Responsible Person	24 hour intervals
<b>Unfired</b>	No limit	No Limit	Responsible Person	4 hour intervals

\*Special conditions apply for manning, controls and alarms.

Possible operator cost scenarios were examined for the attendance categories listed in Table 1.3. For this analysis, it is assumed that a qualified operator receives remuneration at \$25/hr, whereas a 'responsible person' is paid at \$20/hour (Careers, May 2014). The electricity sale price is set at \$80/MWh and the attached ORC systems are assumed to generate power with a 10% net thermal efficiency. Each 'check' period is assumed to take 1 hour.

**Table 3.3: Estimated operation cost for several worst and best case scenarios.**

Boiler size (MW)	Boiler Pressure (bar)	Supervision type	Operator hourly pay	Operator attendance factor	Equivalent elec. Sales (kW capacity)	ORC kW capacity	Operation cost as % of electrical sales
<b>20</b>	Any	Attended	\$25	1	313	2000	16%
<b>6.01</b>	Any	Attended	\$25	1	313	600	<b>52%</b>
<b>5.99</b>	<17	Limited Attendance	\$25	0.17	52	600	9%
<b>5.99</b>	<17	Unattended	\$20	0.0417	10.4	600	2%
<b>6.00</b>	Any	Unfired	\$20	0.25	62.5	600	10%

Table 3.3 indicates that the operator can become a significant cost in certain scenarios. Most prominently, the cost becomes untenable when an operator is required in continuous attendance operation (who would otherwise not have to be present, e.g. for operation duties apart from the ORC system).

- For most medium scale systems (600 – 2000 kWe) in distributed generation scenarios, hiring an operator would be prohibitively expensive at 16%-52% of the electricity revenue. This limits the number of scenarios to which biomass systems can be applied without a thermal-oil loop under current guidelines.
- Boilers less than 6 MW<sub>th</sub> must be selected to operate under 17 bar to avoid operation costs at above 52% of revenues. This eliminates the possibility of feeding refrigerant into the biomass boiler directly for several working fluids and/or trans-critical and supercritical designs. A thermal oil boiler and heat transfer loop would be required in this case.

These operation requirements also indicate a potential advantage of using multiple, smaller boilers, as having discrete boilers below 6 MW<sub>th</sub> will allow for unattended operation, reducing the continuous costs.

### 3.2.3. Evaporators in high-pressure cycles

An often cited cause of ORC heat exchanger inefficiency is due to the large temperature differences required in parts of the evaporator, in order to maintain a reasonable minimum pinch point temperature (Cayer, Galanis, Desilets, Nesreddine, & Roy, 2009; Hung, Shai, & Wang, 1997), as can be seen in Figure 3.3. This can be avoided by using high-pressure cycles, such as the supercritical and trans-critical ORC cycles. The supercritical cycle is sometimes also referred to as the Brayton cycle, as no phase change takes place.

In the supercritical ORC cycle, both the evaporation and condensation processes occur above the critical temperature. In the trans-critical cycle, the vaporisation occurs above the critical temperature, but the condensation does not (Vidhi, Kuravi, Yogi Goswami, Stefanakos, & Sabau, 2013). While high-pressure supercritical and trans-critical ORC cycles offer improved heat transfer, they are still yet to be installed in commercial systems (Rojas, 2014), having required extensive development in the past decade to overcome their practical constraints (Man-Hoe Kim, 2004).

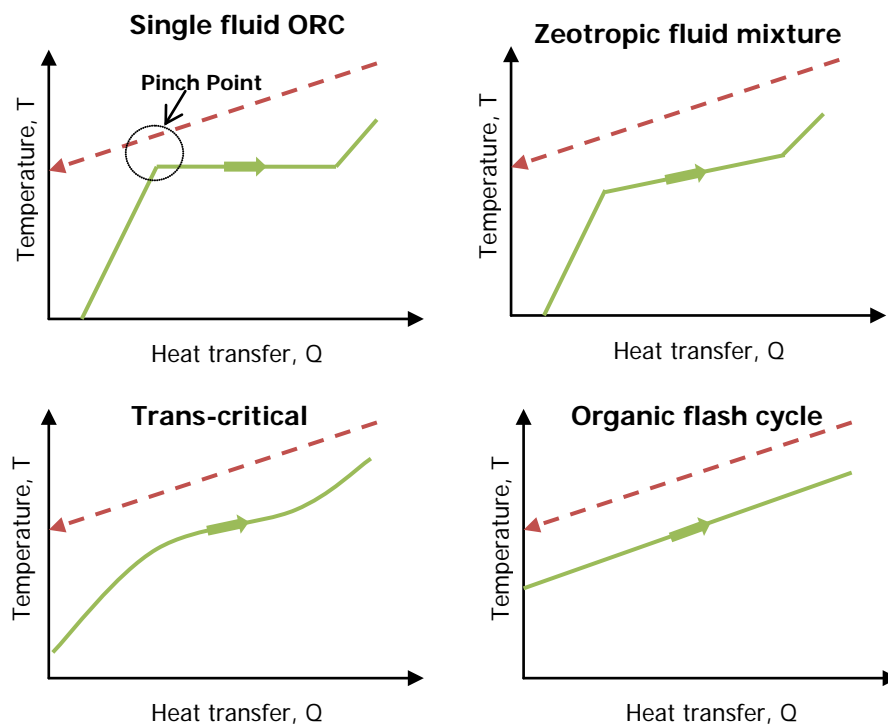

**Figure 3.3: Variation in fluid temperatures during the heat addition process for a single component, zeotropic, transcritical and flash cycle ORCs. Organic flash cycle (OFC) heat transfer characteristic from (Ho, Mao, & Greif, 2012).**

Placing the evaporation process in the supercritical region can reduce the size requirements of the evaporator, but at the cost of significant 'high side' pressures. These high pressures can increase the cost and technical requirements of the evaporator, especially for plate-type heat exchangers, as well as increasing the operator attendance requirements.

As an example, a study by (Schröder, Neumaier, Nagel, & Vetter, 2014) selected a heat exchanger for a geothermal ORC with a 1 MW thermal heat transfer requirement at a 60 bar supercritical fluid pressure. The study concluded that a plate heat exchanger would be most suitable provided that a welded design wasn't necessary, otherwise a shell and tube heat exchanger would have to be used. This is because welded designs are difficult or even impossible to clean, relying on chemical treatments, and so are not suitable for geothermal brines. The maximum pressures of commercial plate heat exchangers from a range of manufacturers are shown in Table 3.4.

**Table 3.4: Maximum pressures of common types of plate heat exchanger from manufacturer data (GEA, 2011, 2012; Kaori, 2011; Laval, 2014; Tranter, 2010)**

<b>Plate HX Type</b>	<b>Maximum available pressure rating (bar)</b>
Gasketed (Bolted)	25 – 29 bar
Brazed	45 – 140 bar (specialist options for CO <sub>2</sub> )
Welded and semi-welded	100 – 160 bar

As shown in Table 3.4, gasketed plate heat exchangers appear to only be available at pressures below 30 bar, and so while they are suitable for many subcritical ORC designs, they cannot be used to directly heat the working fluid in higher pressure cycles. The use of a thermal oil loop between the heat source and the refrigerant can be used to overcome this limitation, as this arrangement places the high-pressure and cleaning requirements in separate heat exchangers.

### 3.2.4. Superheating and subcooling

#### *Superheating*

Superheating is when heat energy is added to the working fluid such that its temperature increases beyond the saturation temperature. In terms of ORCs, this usually refers to the heating that can occur in the evaporator before the fluid enters the expander. Superheating pushes the expansion process out into a higher-entropy region in the T-s diagram (Figure 1.1), increasing the amount of heat that must be rejected from the fluid in its gaseous state (desuperheating) after the expansion process (Roy, Mishra, & Misra, 2011). Some working fluids with lighter molecules, 'wet fluids', may require a small amount of superheating to avoid the formation of liquid droplets in the expander (Tchanche, Lambrinos, Frangoudakis, & Papadakis, 2011). The amount of superheating in Rankine cycle systems is regulated by the relative volumetric fluid flow rates in the pump and expander for a given heat input condition (Quoilin, 2008). Large commercial ORC systems are usually designed to minimise superheating to around 2°C (Invernizzi, 2013).

For systems with turbomachinery expanders that can be designed to efficiently extract work across large pressure ratios, superheating is generally undesirable as it reduces the amount of enthalpy that can be extracted (Dai, Wang, & Gao, 2009). A cycle that uses superheating can be economic for small and medium ORC systems however, as it may allow the use of a cheaper single-stage expander in some scenarios, which can achieve a high isentropic efficiency at expansion ratios of up to 5 – 6 (Japikse & Baines, 1997). If the choice of working fluid is limited, some superheating may also be necessary in order to extract more enthalpy when the evaporation occurs near the working fluid's critical point. In this region of the T-s diagram, higher evaporating pressures act to reduce the heat of vaporisation, and so increase flow rate requirements for a given heat rate (Figure 3.10).

For systems with fixed-volume expanders, such as scroll or screw expanders, some superheating can also be beneficial. Fixed-volume expanders can only efficiently extract work across a specific pressure (volume) ratio (Lemort, Quoilin, Cuevas, & Lebrun, 2009). In this case, adding superheat adds to the enthalpy of the fluid without increasing the pressure. This can lead to a cycle with good heat extraction for a given evaporator area (Quoilin et al., 2011), and an increase in power output for volumetric expanders (Quoilin, 2008), without adding to under-expansion losses (Quoilin, Broek, Declaye, Dewallef, & Lemort, 2013).

### ***Subcooling***

Subcooling is when the working fluid is cooled below the saturation temperature. In terms of ORCs, this normally refers to the subcooling that occurs in the condenser before the fluid enters the pump. Subcooling is not desired thermodynamically, as it is a sign of reduced efficiency (Hung et al., 1997) while at best providing a small potential reduction to pump work (own study). Even so, a small amount of subcooling may be required by the time the flow reaches the pump inlet, as minimal subcooling can result in vapour formation, increasing pump work and potentially damaging the pump (Lemort et al., 2009). As a result of this, large commercial ORC plants are often designed to have a small amount of subcooling at the pump inlet, in the order of 2°C (Invernizzi, 2013).

If the condenser is over-sized, subcooling can most easily be imposed by adding refrigerant charge (Quoilin, 2008) or non-condensable gasses to the cycle (Section 3.3.3.), although this will eventually begin to increase the condensation temperature. Another method to impose subcooling without changing the heat flow requirements is to position the pump a sizeable distance below the condenser, thereby increasing the pressure at the pump inlet but not in the condenser. In systems where ease of installation is important, it may be beneficial to add a pump with a low NPSH requirement as a pre-feed pump (Quoilin et al., 2013), in order to increase the pressure slightly before the working fluid enters the main system pump.

### 3.2.5 Economic study of a CO<sub>2</sub> high-pressure cycle

In a study by (Y. Chen, Lundqvist, P., Johansson, A., Platell, P., 2006), a comparison was made between a trans-critical CO<sub>2</sub> cycle and a traditional ORC with R123 as the working fluid. The hot side temperature was set to 150°C and the mass flow rate to 0.4 Kg/s.

The results of the simulation showed that the CO<sub>2</sub> cycle can provide a higher net power output than the R123 ORC for a fixed heat exchanger geometry. Table 3.5 lists key specifications of the two designs;

**Table 3.5: Summary of cycles using CO<sub>2</sub> and R123 at maximum power output, adapted from (Y. Chen, Lundqvist, Johansson, & Platell, 2006)**

Key metrics	Sub-critical R123	Trans-critical CO <sub>2</sub>
High side pressure	5.87 bar	160 bar
Power output	3.25 kW	3.3 kW
Efficiency	10.6%	9.5%
Mass flow rate	0.14 kg/s	0.165 kg/s

While the CO<sub>2</sub> cycle allows for better heat transfer efficiency, leading to smaller heat exchangers for a given power output, Table 3.5 shows that there are also negative trade-offs to the cycle. Most significantly, the high-side pressure in the trans-critical CO<sub>2</sub> cycle is much higher than that of the R123 cycle. This can be expected to increase the high pressure component costs by about 15%, using the Lang factor method for the cost estimation of high pressure systems (Gerrard, 2000).

$$C_{CO_2} = 1.15 (C_{turbine} + C_{pump} + C_{Evaporator}) + C_{others} \quad (3.8)$$

Using similar operating conditions to the study by Chen et al., Figure 9 in a study by (Li et al., 2014) showed that R123 can be expected to have a necessary total heat transfer area 75% larger than the trans-critical CO<sub>2</sub> cycle. Using the formulas for stainless steel plate heat exchangers in Table A3.1, a 75% increase in the size of a heat exchanger can be expected to increase its cost by 32% (Equation 3.9).

$$C_{HX,R123} = 3370 \times (1.75A_{CO_2})^{0.489} \times I_f = 1.32 C_{HX,CO_2} \quad (3.9)$$

$$C_{CO_2} = 1.15 (C_{turbine} + C_{pump}) + \frac{1.15}{1.32} C_{Evaporator,R123} + \frac{1}{1.32} C_{Condensor,R123} + C_{others} \quad (3.10)$$

If it is assumed that the evaporator and condenser is of similar size and cost (as is common in ORC cycles), then it follows;

$$C_{CO_2} = 1.15 (C_{turbine} + C_{pump}) + 0.814 C_{HXers,R123} + C_{others} \quad (3.11)$$

I.e. the heat exchangers of the R123 cycle must have a cost component of at least 97% that of the turbine and pump combined, in order for the CO<sub>2</sub> cycle to be able to provide a smaller SIC; assuming that all other components, costs and revenues of the two cycles are considered equal.

### 3.3. Variable operating condition (off-design) economics

Off-design refers to situations where an ORC system must be run under conditions outside of the design point, such as a lower evaporation temperature, mass flow rate, or condensation temperature. These conditions affect the performance of all of the components in the cycle, but can especially affect turbo machinery such as centrifugal pumps and turbines. Operating ORC systems under off-design conditions will reduce their capacity factor depending on the magnitude, type, and duration of the changes, as well as the behaviour of any off-design mitigation systems in place.

In general, ORC systems have favourable off-design performance when compared to steam cycles (Reisenhofer, 2002). One report by the manufacturer Turboden indicates almost no overall efficiency loss for heat input changes around  $\pm 10\%$ , and about 1/5 of the efficiency is lost (i.e. a reduction from 20% to 16% net efficiency) for heat input changes in the order of  $\pm 20\%$  (Bini, 2010).

#### 3.3.1 Variable heat source and storage

Variable heat and cooling sources can be accounted for in to ORC design in several ways, depending on the nature of the variation;

- If the variations are relatively small but for long periods of time, such as in a geothermal system with known declining well enthalpy, or a biomass ORC system supplying district heating over summer, then the design point of the system is shifted in order to optimise the overall performance. Cogeneration systems can also be designed to 'split off' some of the heat source to directly heat the cooling source after the condenser. This acts to maintain a low condensation temperature while meeting constant thermal output requirements, and keeps the ORC operating closer to design conditions (Bini, 2010).
- If the variations are large but for short periods of time, such as in WHR applications, then a secondary heating loop with thermal storage can be included to smooth the heat rate over time. This thermal storage may be achieved with thermal oil or a phase change material (PCM).
- If variations are large and for moderate/long periods of time, then thermal storage will become prohibitively expensive (Section 3.3.2). One response is to install multiple smaller units with some thermal storage, such that the units can be switched on or off as the heat input changes (Section 3.3.4). Alternatively, some recent commercial systems have been designed to switch between multiple heat sources, such as the Ait Baha cement WHR / solar thermal plant in Morocco (Turboden, 2015).



### 3.3.2. Steel mill example – KOBM hood

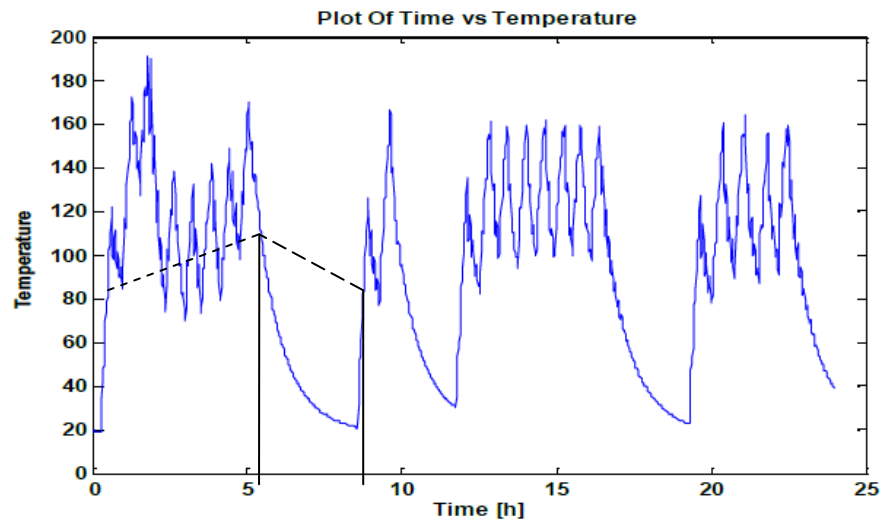

**Figure 3.4: Example temperature profile of steel plant KOBM hood. Image adapted from Figure 3.1.1 in (A. Finch, 2012). An illustrative example of the possible heat storage temperature and the maximum time with zero heat input is indicated.**

In a report by (A. Finch, 2012), it was determined that a 1.8 MW<sub>e</sub> WHR plant could be designed to operate intermittently from a steel mill's Kombiniert (Combined) Oxygen Blown Maxhutte (KOBM) hood cooling circuit. In the report, the proposed ORC system has an evaporation temperature of 90°C and an overall heat to electrical output efficiency of 7.7%. Over 24 hours, the designed plant is expected to provide an average output of 942 kW<sub>e</sub>.

In this section, a smaller WHR-ORC, coupled with a storage system designed to provide a lower heat rate is investigated. The storage system is sized to facilitate the continued running of a WHR-ORC over the long shut-off period between hours 5-8 in Figure 3.4. It is assumed that the average temperature of the heat storage is sufficient such that the overall efficiency of the smaller WHR-ORC remains close to the 7.7%, as estimated for the system in the report by (A. Finch, 2012).

**Table 3.6: Approximate calculation for thermal energy that must be stored within a single KOBM hood cooling water temperature cycle.**

Average power output	942 kW <sub>e</sub>
Average total thermal efficiency	7.67%
Average thermal energy input rate	12.3 MW <sub>th</sub>
Cycle pause duration (approximate)	195 minutes
<b>Thermal energy required</b>	<b>39.9 MWh<sub>th</sub>*</b>

\*This result is comparable to the storage required for a 1MW<sub>e</sub> system in (Mario Veroli, 2014).

The thermal storage cost using thermal oil, can be approximated by Equation 3.12. Adapted from (Mario Veroli, 2014).

$$\text{Thermal Storage (NZD 2014)} = 115 \times \text{kWh storage requirement} \quad (3.12)$$

Equation 3.12 gives the estimated cost of the thermal storage for the KOBM hood case to be \$4.6M NZD. At an average WHR system cost of \$6080 NZD/kW (from the system survey in Section 1.5), the 942kW WHR ORC system will cost approximately \$5.7M NZD. The total cost of the system with thermal storage is therefore approximately \$10.3M NZD in 2014.

Using the same specific cost figure, a larger 1.8 MW ORC without storage (to be run only when sufficient heat is available) will cost approximately \$10.9M NZD, 6% more than the system with storage. Although both systems have similar capital costs and provide similar annual electricity generation, they both are not likely to be economic; the system with storage has a large resource gathering component cost, pushing the specific cost to \$11,600/kW, while the 1.8 kW plant will have a low capacity factor, near 50% (Equation 1.9).

The most economic option in this scenario would likely comprise of a smaller thermal storage system that is designed to let the ORC system run continuously, but with a heat input slightly below design conditions when the KOBM hood temperature is low. This would reduce storage costs, but only limited reductions to the storage system size would be feasible, as the efficiency of turbomachinery sharply decreases when operating far from the design point (Japikse & Baines, 1997). This decrease in efficiency would be especially large for the low-temperature ORC considered, due to the relatively large temperature swings of the heat source. It also should be considered that the size of any storage system will be very large, i.e. a 2500 m<sup>3</sup> volume of thermal oil will be required for the example scenario if a temperature glide of 30°C is assumed, which is not likely to fit in a tight industrial setting. The use of a phase change material (PCM) could significantly reduce the size requirement, although at a greater cost.

### 3.3.3. Non-Condensable Gas (NCG) build-up

It is sometimes possible that atmospheric and introduced non-condensable gasses (NCGs) can infiltrate the working fluid on an ORC. During operation, the non-condensable gasses get pushed around the system until they accumulate at the vapour/liquid interface of the condenser. This results in reduced heat transfer efficiency in the condenser, increasing the condensing temperature and reducing the turbine power output (Quoilin, 2007). During periods of non-operation, the lower density of NCGs when compared to refrigerant vapour means that buoyancy forces direct them towards the top of the system.

Mechanisms for NCGs entering the working fluid line of the system are (Mohr, 2002; Quoilin, 2007);

- On cold days, some working fluids will have a partial vapour pressure below atmospheric. NCGs may be able to be sucked into the system through small leaks under these conditions.
- Nitrogen or a similar gas may be used as a flushing agent before charging the system, some of which can remain after the charging process.
- Entry through turbine lubricant treatment and recycle systems.
- NCGs can also be formed from the working fluid, such as the cracking of heavier hydrocarbons into lighter, non-condensable forms.

The presence of NCGs can either work to reduce the ORC output due to off-design working conditions, or require additional systems to accommodate for their removal. Commercial systems have been found to manage NCGs using the following methods;

- By passing the condenser vapour through a vacuum pump and a semi-permeable membrane that allows the working fluid to pass through while capturing the NCGs. (Mohr, 2002)
- By using a drain valve on the condenser to periodically release vapour from the system. Working fluid included in the purged mixture may then be recovered using refrigerated condensers (Buchanan T., 2010).
- By selecting the working fluid such that its partial pressure is always above atmospheric throughout the system.
- By heating a part of the system continuously in order to increase the pressure above atmospheric (Mohr, 2002).

Systems and maintenance to reduce NCGs are usually considered economic; the expected potential economic gain of NCG removal for binary geothermal plants is around 2% of the system's net power output (Mohr, 2002). Using this as an example, for an ORC with a nominal cost of \$5000/kWe, a NCG removal system would reduce the SIC if it costs less than \$100/kW of the ORC's net electrical output.

### 3.3.4. Modularity

In small ORC installations, the total design costs become large relative to the rest of the unit price (Section 3.1.2). To help to mitigate this, the majority of commercial ORC manufacturers surveyed in Section 1.4 supply a range of smaller, fixed-sized ORC models that can be adapted to a variety of heat resources. This manufacturing approach reduces the total ORC design time per installation, and can help to reduce the unit capital and maintenance costs through economies of scale.

While their commercial prevalence indicates that there are significant advantages to the production of standardised models for smaller installations, larger installations may also benefit from using multiple smaller ORC units for different reasons. The use of multiple units to fill a single installation capacity can provide redundancy, and lead to the use of more standard and transportable component sizes. Many larger ORC installations use multiple units (from survey in Section 1.4); often two in larger biomass and geothermal applications, but sometimes more, such as the Ngatamariki plant outside of Taupo, which consists of four identical 22 MW<sub>net</sub> ORC heat exchanger and turbine sets.

A summary of the advantages and disadvantages of providing several modular ORC units for larger installations are outlined in Table 3.7.

**Table 3.7: Advantages and disadvantages of developing multiple modular units for a given power requirement. Information from (UTC Pratt & Whitney, 2009) and communication with Alastair Scott of Geothermal development Associates (GDA) at the 2014 NZGW.**

Advantages of modularity	Disadvantages of modularity
<ul style="list-style-type: none"> <li>• Units can be sized to take advantage of standard part sizes, manufacturing, and assembly.</li> <li>• Reduced risk as units can be added as needed, and sold if demand or resource underperforms.</li> <li>• Shorter time between unit purchase and initial payback.</li> <li>• Compact and predefined transportation sizes.</li> <li>• Easier maintenance due to re-use of service procedures.</li> <li>• Higher capacity factor as maintenance will only require a partial, rather than a complete offline.</li> <li>• Potential reductions in supervision and safety system requirements.</li> </ul>	<ul style="list-style-type: none"> <li>• Overall capital investment may be more costly due to smaller scale parts.</li> <li>• A larger number of parts, leading to more maintenance hours and replacement orders.</li> <li>• Potentially greater operator workload.</li> <li>• Increased instrumentation requirements.</li> <li>• An efficient turbomachine may be difficult to develop for smaller systems due to geometric constraints (Japikse &amp; Baines, 1997).</li> </ul>

The most economical size and number of units to be installed for a specific resource depend on a large number of factors. An example theoretical model was evaluated in Engineering Equation Solver (EES) to determine compare the chosen number of modular units on an example case.

**Example theoretical case - modularity**

A system sizing code for a 173°C heat source was investigated and two options were presented;

1. One x 1 MW unit. An additional cost factor of 100% is assumed for this case (Figure 3.1).
2. Two x 500 kW units. An additional cost factor of 85% is assumed.
3. Ten x 100 kW units. An additional cost factor of 80% is assumed.

The heat exchanger surface areas were estimated using the LMTD method (Equation 3.12) and assumed U-values from (Perry, 2008), as presented in Table A3.5. The heat exchanger costs were estimated using Figure 3.5. Other costs were estimated using the formulas presented in Table A3.1.

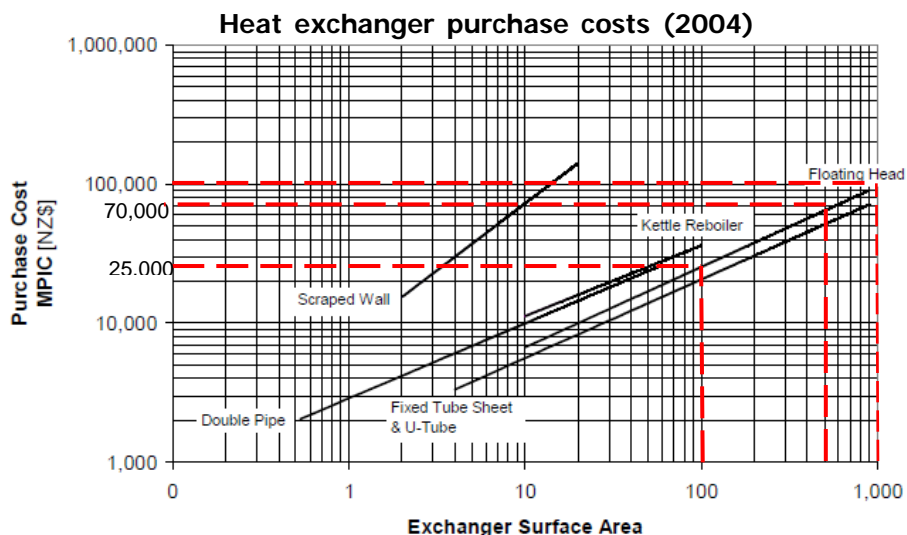

**Figure 3.5: Purchase cost estimates of shell and tube heat exchangers as a function of surface area. Image adapted from Figure 8.17 in 'Process capital cost estimation in NZ' by the Society of Chemical Engineers New Zealand (Bouman R.W., 2005). Costs were afterwards converted to July 2014 NZD using the NZ PPI.**

It was found that the estimated SIC component cost of a single system was \$3173/kW, whereas the two systems cost \$3787/kW, and the 10 smaller systems come with an SIC of \$6574/kW. The cause of the higher component cost in the smaller systems is from the economies of scale assumed by the pricing formulas when using larger components (Figure 3.5). Although the large single-unit system may have a cheaper SIC, this advantage is reduced if the larger capacity factor achievable by the modular units were to be considered. This advantage may be further reduced in reality, as the production of multiple identical units also offers an economy of scale not indicated by the pricing formulas in Table A3.1, and the modular units would be applicable to a larger proportion of resource scenarios, increasing the design's reusability.

In the considered example, the two-unit system is likely to be a good compromise. If it can provide a 50% reduction in effective annual shut-downs, the two-unit option will have an equal SIC to the single-unit system if annual shut-downs amount to five weeks per year or greater, something that would not be achievable by the 10-unit system. In real world systems, the best choice of system size is much more complex, but the illustrative case in this section shows that the initial split from a single to a dual-unit arrangement is not likely to result in a significant increase to the SIC, while providing some potential advantages.

### 3.4 ORC component economics

As mentioned in Section 1.3, technological improvements to ORC systems act to improve their specific investment cost, their operating and maintenance costs, or to decrease risk. The specific price of an ORC can be improved in one of two ways, by reducing the investment costs, or by increasing the plant net output power;

$$SIC \left( \frac{\$}{kW} \right) = \frac{I}{Plant\ Size_{net}} \quad \text{Equation 1.1, Table 1.2}$$

Where  $I$  is the capital investment.

Most ORC design decisions affect both the numerator and the denominator of Equation 1.1. This section presents guidelines for whether a decision will increase or reduce the SIC for the following general cases;

- Expander isentropic efficiency improvements / reductions
- Heat exchanger PPTD increases / reductions
- Regenerator size increases / reductions

For this analysis, the term 'justified' is used to indicate when technology changes act to reduce the specific price of the system.

### 3.4.1. Expander

Expander designs are primarily rated by their isentropic efficiency (Japikse & Baines, 1997). The relationship between expander isentropic efficiency and power output is linear and equal; an expander with an isentropic efficiency of 80% can be expected to have a gross output power that is twice that of an expander with an isentropic efficiency of 40%.

$$\eta_{Isen} = \frac{\dot{W}_{T_{Actual}}}{\dot{W}_{T_{Isen}}} = \frac{\dot{W}_{T_{Actual}}}{\dot{m}(h_1 - h_{2s})} \quad (3.13)$$

$\dot{W}_{T_{Actual}}$  is the expander output power

$\dot{m}$  is the working fluid mass flow rate

$h_1$  is the enthalpy of the inlet state

$h_{2s}$  is the isentropic enthalpy of the outlet state (where  $s_1 = s_2$ )

The energy profit from an ORC system is measured by the net work output. In order to accurately compare this energy profitability in terms familiar to expander performance, the 'net isentropic work' parameter is introduced. This figure is found by including the parasitic loads in the isentropic efficiency calculation;

$$\eta_{Isen,net} = \frac{\dot{W}_{T_{Actual}} - \dot{W}_P}{\dot{W}_{T_{Isen}}} = \frac{\dot{W}_{T_{Actual}} - \dot{W}_P}{\dot{m}(h_1 - h_{2s})} \quad (3.14)$$

$\dot{W}_P$  is the parasitic load work input (pumps, condenser fans etc.)

Using this metric, any improvement to expander performance can be linked directly to energy revenue, i.e. if an ORC system design replaced its turbine with a better performing model (higher isentropic efficiency), the increase in net output can be represented by;

$$\Delta kW \% = \frac{\eta_{Isen,net,new} - \eta_{Isen,net,old}}{\eta_{Isen,net,new}} \quad (3.15)$$

The  $\Delta kW$  % figure represents the percentage increase in the denominator of the SIC equation (Equation 1.1). Furthermore, the percentage increase in total investment cost,  $I$ , can be represented by the change in turbine cost, multiplied by the expander's fraction of the total ORC system cost (Equation 3.16).

$$\Delta I \% = \% \text{ turbine price increase} \times \frac{\text{turbine cost}}{\text{total ORC cost}} \quad (3.16)$$

This is assuming that any system design and operation flow-on effects from changing the expander efficiency can be excluded. Own study with system models in EES indicates that the design flow-on effects of a small change in expander efficiency are negligible, with the condenser size and condensation heat being the most affected parameters. Of the fluids considered in the EES model (R134a, R245fa, Toulene, n-Pentane, Butene), a 10% change in isentropic efficiency resulted in at most a 5% change in necessary condenser size and a 2% change in heat rate.



The expander is often a large portion of the cost of ORCs, especially in smaller systems (Quoilin et al., 2011). As a result, there is a focus in literature on finding low-cost expander solutions, which sometimes may be capable of only limited efficiency (Quoilin et al., 2013). These solutions may take various forms, such as using a volumetric expander, conversion of an existing turbomachine, or the adaptation of a compressor. If these solutions reduce the specific price of the ORC system, they will have a much greater chance at success than solutions which act to increase the specific price.

$$SIC, new = \frac{1 + I \% \text{ increase}}{1 + kW \% \text{ improvement}} < SIC, old \text{ if } \% I \text{ increase} < \% kW \text{ improvement} \quad (3.13)$$

The isentropic efficiency improvement necessary to 'justify' an increase in spending on expander technology in a system with initially 75% isentropic efficiency is presented in Figure 3.6. A parasitic load of 6% of the output of a high-efficiency turbine is assumed, as this reflects that the cost of pumping for ORC systems is typically between 2% – 10% of the total output power (Quoilin et al., 2013). It is also assumed that generator losses are negligible.

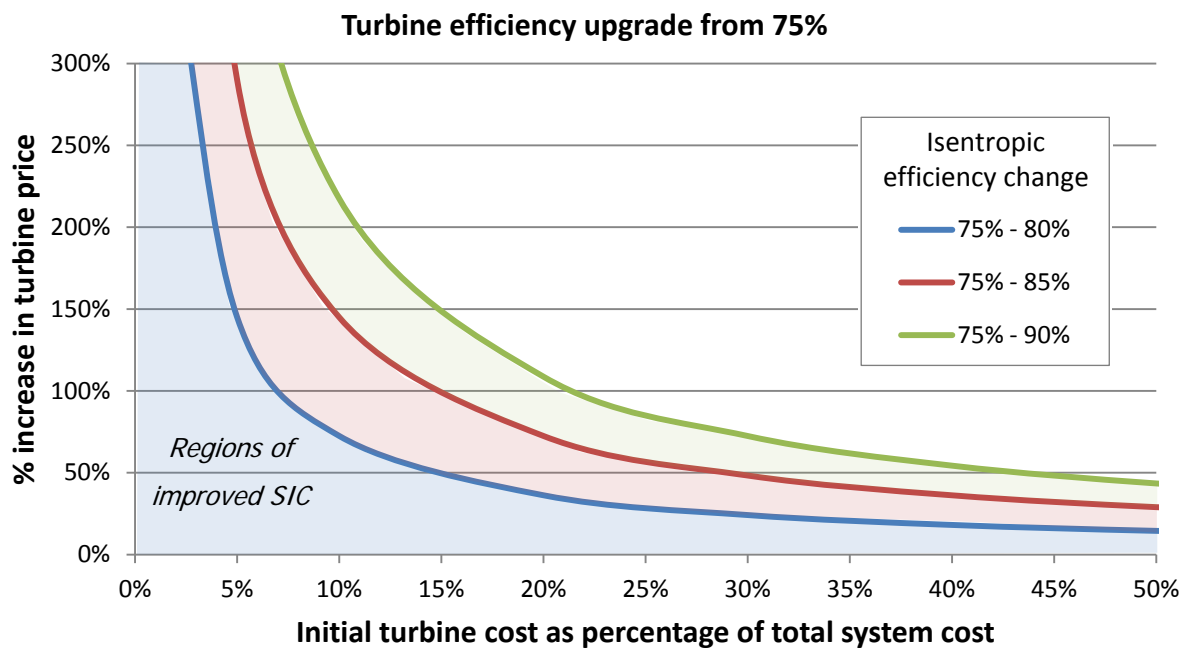

**Figure 3.6: Maximum cost of an investment into a higher efficiency turbine before the specific investment cost will be increased for a single ORC system. A base case isentropic efficiency of 75% is assumed.**

Figure 3.6 shows that the initial fraction of investment spending that goes towards the expander greatly changes the amount that can economically be spent on a higher efficiency unit. i.e. in a small ORC system where the expander represents 30% of the total cost, spending any more than 25% extra on a unit for 5% better isentropic efficiency will increase the SIC. Conversely in large units where the expansion machine may only be 5% of the total outlay, choosing a 5% more efficient unit is worthwhile, even if it costs 2.5 times that of the lower efficiency option.

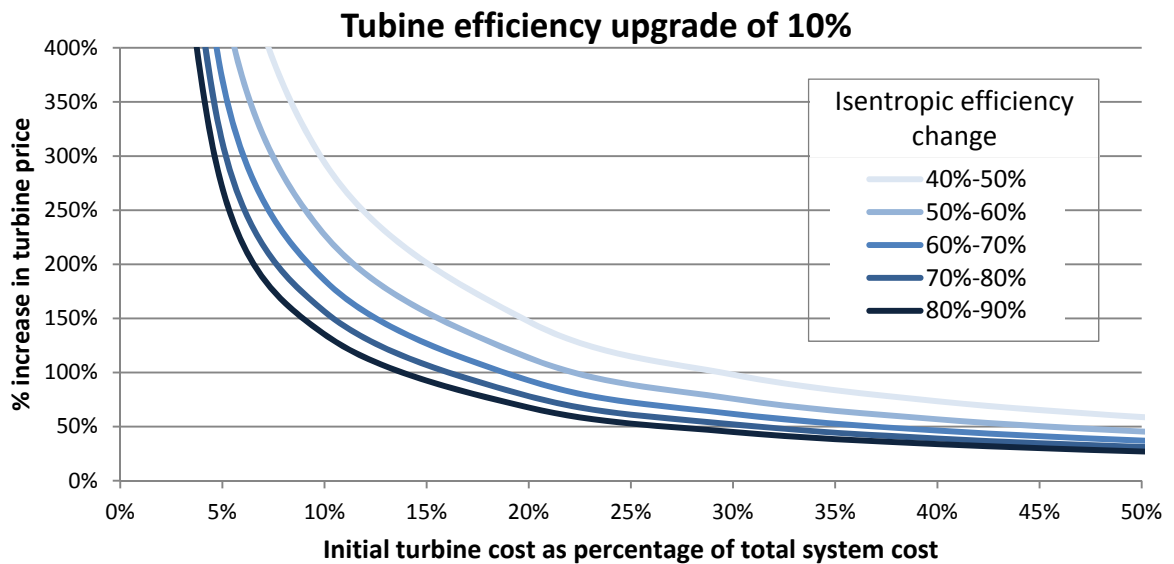

Figure 3.7 Maximum cost of an investment into a 10% higher efficiency turbine before the specific investment cost will be increased for a single ORC system. A base-case isentropic efficiency of 75% and a parasitic load of 6% (for a 90% efficient turbine) are assumed.

It can be seen from Figure 3.7 that the economic value of a 10% increase in isentropic efficiency is greater for low-efficiency turbines than high-efficiency turbines. If system with total parasitic loads higher than the 6% assumed is considered (such as an ORC that uses well pumps or ACCs), the graphs in Figures 3.6, 3.7 and 3.8 will be shifted up and towards the right, indicating that a greater relative cost would be acceptable for a given efficiency improvement.

Conversely, the development of a cheaper alternative expansion machine will not easily improve the economics, if the turbine is already small proportion of the system cost. Figure 3.8 indicates the minimum price decrease that can reduce the system specific price, for a given turbine efficiency sacrifice.

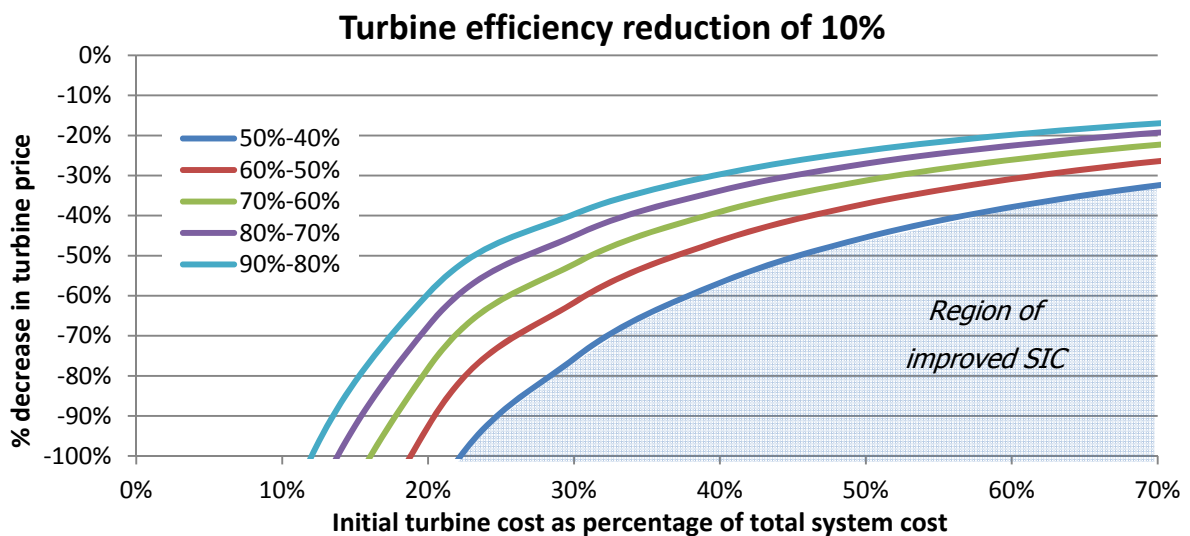
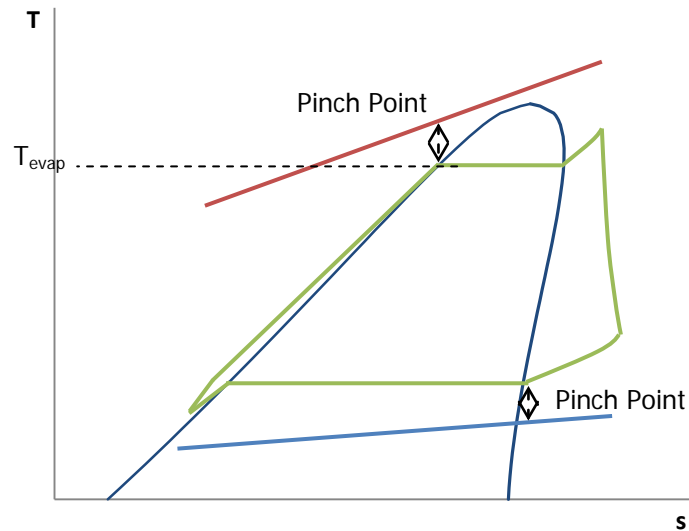

Figure 3.8: Minimum percentage reduction in price for a turbine with 10% lower efficiency that will lower the SIC of the system.

### 3.4.2. Heat Exchanger pinch point

In ORC systems with conventional shell-and-tube (S&T) or plate heat exchangers, the existence of the pinch point limits the amount of heat that can be extracted from the heat source. The result of this is that the heat source temperature cannot be lowered very far below the evaporating temperature of the ORC working fluid (Quoilin, 2008).



**Figure 3.9: T-s diagram of a standard ORC cycle indicating the most common pinch point locations.**

While the maximum theoretical thermal efficiency is achieved with a pinch point temperature difference (PPTD) of zero, this would require an infinitely large evaporator and limit the amount of heat that can be transferred into the cycle. For every thermodynamic situation, there exists a pinch point temperature difference that minimises the specific cost of a power generation cycle (Invernizzi, 2013).

$$SIC_{opt} = \frac{\$=f(PPTD)}{\dot{W}_{net}=f(PPTD)} \quad (3.14)$$

This indicates that in order to maximise the profitability of an ORC design, a pinch point temperature should not be assumed, and instead should be chosen based upon pinch point optimisation unique to each system. As a general guideline, the optimum PPTD for ORC evaporator and condensers usually exists somewhere between 5-10 °C (Quoilin, 2008).

Increases to heat exchanger size adds to the system cost, while reducing the PPTD can improve the power output, thereby affecting both the numerator and denominator of the SIC equation. In order to evaluate the relationships between PPTD and SIC, an example PPTD optimisation is used. Two optimisations are run, one with, and one without an imposed minimum heat source outlet temperature.

### *Development of PPTD model*

The EES model derives the cost of a theoretical S&T evaporator and condenser by using the heat exchanger cost formulas from Table A3.1, and a thermodynamic model in EES. The model uses the LMTD method to determine the necessary heat exchanger size (Nellis & Klein, 2008), separating each heat exchanger into three regions to model the heat transfer for each phase component separately.

$$\Delta T_{LMTD} = \frac{\Delta T_A - \Delta T_B}{\ln \Delta T_A - \ln \Delta T_B} \quad (3.15)$$

Where  $\Delta T_A$  and  $\Delta T_B$  represent the difference between in fluid temperature at each end of the heat exchanger/ phase transition.

$$Q = UA\Delta T_{LMTD} \quad (3.16)$$

Where  $U$  is the overall heat transfer coefficient. General  $U$ -values from (Perry, 2008) are used. These are assumed to remain constant over small variations in operating conditions.

The following assumptions are made in order to make the model as generally applicable as possible;

- A constant  $U$ -value or the heat transfer in each fluid phase, as indicated in Table A3.5.
- No pressure drop across the heat exchangers. Adiabatic components.
- Perfect counter flow arrangement (one dimensional flow).
- No superheating at the evaporator outlet (Section 3.2.4). Due to the lower assumed  $U$ -value for heat transfer to organic vapour compared to liquid and boiling, the lowest SIC was found to occur at all points where the superheating was zero.

In order to compute the efficiency of the entire cycle and hence the relative HX costs, the following temperatures and efficiencies had to be assumed. The assumed conditions are chosen to be typical of ORC cycles;

- Water as the heat source at 173°C. The mass flow rate is fixed.
- The working fluid is n-butane, with a critical temperature of 152°C and a critical pressure of 3796 kPa.
- A constant condensation temperature of 30°C (284 kPa) with 5°C sub-cooling.
- Water at 15°C as the cooling source, with a mass flow rate such that it exits the condenser at 20°C. Under this configuration the PPTD is 10°C at the condenser water inlet, and another pinch point of 10-10.5°C exists at the location indicated in Figure 3.9.
- An expander can be developed for the cycle at any pressure ratio with an isentropic efficiency of 85%. The pump isentropic efficiency is assumed to be 70%.

The approximate areas for both the condenser and the evaporator were computed along two degrees of freedom; the pressure ratio (evaporation temperature) and mass flow rates. The net power output of the ORC cycle was computed, and the minimum heat exchanger SIC was found.

**Model results 1 – no imposed minimum heat source exit temperature**

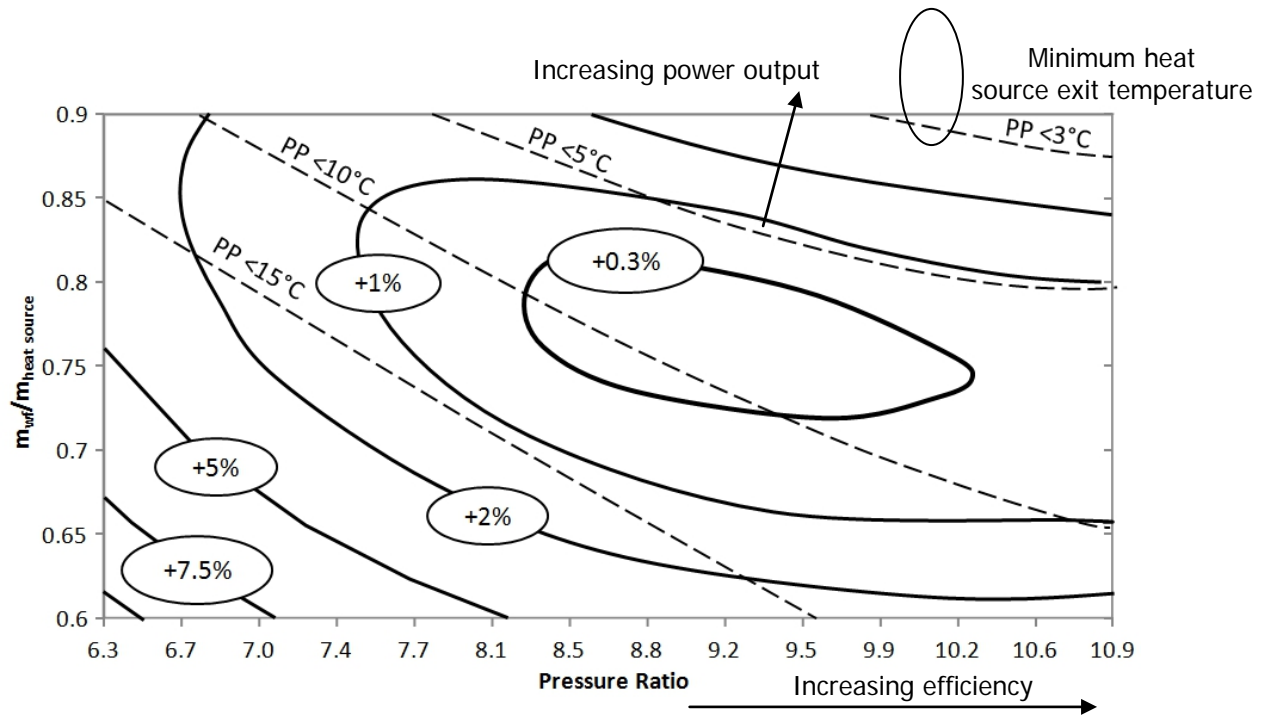

**Figure 3.10: Contour plot showing region of minimum specific investment cost for system considered vs. mass flow rate and evaporation pressure/pressure ratio. Contour bands of increasing relative SIC are indicated. The evaporator PPTD ranges are also indicated by the dotted lines.**

The results of the optimisation indicate several key findings;

- The region of minimum SIC was found to occur in a region with a PPTD between 7 and 11°C.
- A higher pressure ratio lead to a higher efficiency system, and a higher working fluid mass flow rate increased the power output. Increasing the mass flow rate also decreases the heat source exit temperature, with the minimum occurring at a PPTD of zero and a pressure ratio of 10.1.
- Regions where too high of a pressure ratio and mass flow rate was imposed (top-right corner) had a very low PPTD, requiring a very large evaporator and so a high SIC
- If the expansion turbine were to be included in the SIC calculation, it will shift the optimal PPTD towards a lower pressure ratio and mass flow rate, as a higher pressure ratio requires a more complex turbine with more expansion stages (Japikse & Baines, 1997).

Another local minimum not indicated in Figure 3.10 was found close to the critical pressure, but in this region the saturation curve for n-butane bends back on itself (Figure 3.9). This region was excluded as it would require a very high pressure ratio from the expander, and with no superheating imposed it would lead to a significant wetness fraction during the expansion process.

### Model Results 2 – minimum heat source exit temperature of 100°C

The optimal point in the *model results 1* section exists when the heat source is cooled from 173°C to a temperature in the region of 60°C. As a minimum temperature is often imposed on cycle designs, the simulation was also run with a minimum temperature of 100°C. This effectively limits the heat transfer to a set value, and at a SIC-minimising 0°C superheating, it also imposes the working fluid mass flow rate to a set value for each given pressure ratio. The single remaining degree of freedom, the pressure ratio, can be varied to locate the minimum SIC.

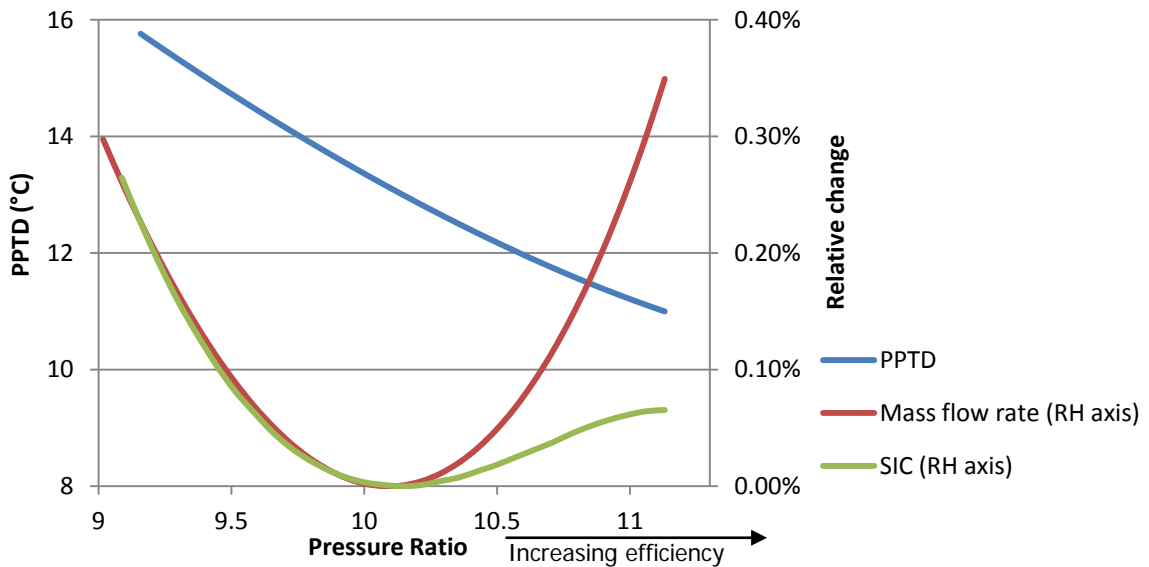

**Figure 3.11: Pressure ratio vs. evaporator PPTD of modelled ORC system with a minimum heat source exit temperature. The SIC and mass flow rate requirement relative to the minimum value is indicated.**

The inclusion of a minimum heat source temperature limit has shifted the optimal design point to that of a higher pressure ratio (10.2) and a lower working fluid mass flow rate (65% that of the heat source) than when there was no limitation (Model 1). Other key findings are;

- The minimum SIC is only 1.4% higher than the minimum for the system without a heat rate (minimum temperature) limitation, while the net power output is 19% lower.
- The minimum SIC occurs near to the local minimum mass flow rate. This is because the minimum mass flow rate indicates when the heat transfer is most effective, as the actual quantity of heat energy transferred is the same across all the pressure ratios displayed in Figure 3.11.
- The optimal PPTD is 13°C, slightly higher than in the case with no minimum temperature limit (Model 1). This is because the gradient of the heat source's curve as it cools is less steep than in Model 1, increasing the PPTD.
- The SIC remains less than 0.3% above the local minimum for pressure ratios between 9 and 11, a higher range than what was found in Model 1.

The system design flow-on effects, found from EES modelling, are outlined in Table 3.8. The strength and magnitude of these relationships were evaluated by arranging the entire array of model results (all the grid points in Figure 3.10) in terms of PPTD, and then by fitting a trend line between the PPTD and the other variables. A 'strong' relationship corresponds to an  $R^2$  correlation value of greater than 0.9, a 'moderate' relationship corresponds  $0.75 < R^2 < 0.9$ .

**Table 3.8: Summary of system design flow-on effects from decreases to the PPTD.**

Flow-on effect	Relationship	Strength
Higher mass flow rates (For a given pressure)	A 1°C decrease in PPTD = 1%-3% increase in $\dot{m}_{wf}$ , with the sharper increases occurring at greater pressures	Strong
Lower heat source exit temperature/higher heat rate (For a given pressure)	A 1°C decrease in PPTD = 3%-6% decrease in the heat source exit temperature (over the minimum) with the sharper decreases occurring at greater pressures	Strong
Lower power output	1°C decrease in PPTD $\approx$ 2% increase in net output.	Moderate
Higher total HX size and cost	1°C decrease in PPTD $\approx$ 3% increase in total HX area, 2% increase in cost with a higher rate of increase at smaller PPTD values.	Moderate
Higher evaporator HX size and cost	1°C decrease in PPTD = 3-20% increase in total HX area, with a higher rate of increase at smaller PPTD values.	Strong
Higher condenser size and cost	1°C decrease in PPTD = 2-3% increase in total HX area, with the higher rate of increase occurring at higher pressures.	Moderate
Net efficiency	No noticeable change to efficiency	N/A

### 3.4.3. Regenerator

A regenerator is a heat exchanger that is used to capture the excess heat in the exhaust stream of a turbine, and transfer that heat to the high pressure liquid before it enters the evaporator. This component may also be referred to as a recuperator, desuperheater, or preheater.

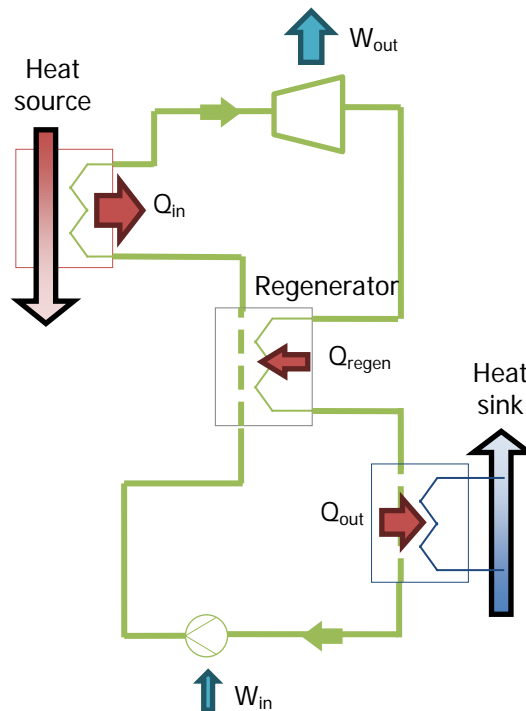

**Figure 3.12: Schematic representation of an ORC with regenerator.**

The heat transfer in a regenerator reduces the load on the evaporator and condenser by 'desuperheating' the fluid at the turbine exhaust and 'pre-heating' the fluid before it enters the evaporator. For a given power output, the inclusion of a regenerator in a Rankine cycle system results in a greater overall heat transfer area, a higher heat source exit temperature, and a reduced condenser heat transfer requirement.

The regenerator is a common component in Rankine cycle systems that use an expensive fuel source. A regenerator reduces the heat requirement from the evaporator, decreasing the cost of fuel for a given amount of power input. As ORC systems do not require an expensive fuel, it may be preferable to use a larger evaporator to cool the heat source down further, instead of recapturing heat with a regenerator (Dai et al., 2009). Despite this, regenerators are included in many commercial systems (Quoilin et al., 2013) and recommended by thermo-economic analysis (Calise, Capuozzo, Carotenuto, & Vanoli, 2014). This is because many resource scenarios place restrictions on the heating and cooling sources;



- There may be a lower temperature limit to which the heat source can be cooled down. This is common for geothermal systems, where the reinjection of brine at low temperatures increases the risk of scaling, in CHP plants where the heat source has further uses, and in flue gas heat recovery when an acid dew point must be avoided. It also can result from the system design, due to the existence of a pinch point in the evaporator (Section 3.4.2). The inclusion of a regenerator in this scenario allows for a system with a greater net power output, reducing the specific investment cost (SIC).
- There is a non-negligible expense to additional cooling, such as when air-cooled condensers are used. The inclusion of the regenerator will reduce the parasitic loads in this scenario, reducing the discounted payback period (DPP), and increasing the net present value (NPV). This is particularly the case when dry working fluids are used, which may have a large superheating temperature at the expander exhaust (Dai et al., 2009).
- The gaseous working fluid has preferable heat transfer properties to that of the heat source (such as in some flue gasses). In this scenario, the inclusion of a regenerator may occasionally decrease the investment costs,  $I$ , as the size requirements of the evaporator may be significantly reduced.

In order to indicate how a regenerator can improve the economic performance of a system, an example EES model for an ORC with and without air-cooling is used. The imposed model conditions are that the 173°C heat source must exit the evaporator at no less than 100°C. The following assumptions are made;

- n-pentane is used as the working fluid.
- The nominal turbine exit temperature is 70°C. The ambient temperature is 25°C. The working fluid condensation temperature is 40°C. A turbine expansion ratio of 6 is imposed.
- The plant capacity factor is 90%, the discount rate is 5% and the electricity sale price is 8¢/kWh. The lifetime of the system is 25 years.
- Pressure drops across the heat exchangers are assumed to be negligible.
- The heat exchanger size requirements were calculated using the LMTD method (Nellis & Klein, 2008), with assumed average U-values for organic fluids in various states in shell-and-tube heat exchangers from (Perry, 2008).
- The formulas from Table A3.1 were used to estimate the relationship between shell-and-tube HX area and cost. The cost formulas used are most applicable to systems under 3 MW in size.
- The parasitic load for the ACC and evaporative cooling were estimated from manufacturer data (Cooling Tower Systems, 2013).

Figure 3.13 shows the DPP, NPV/kW (regenerator only) over a 25 year lifetime, and the additional SIC of including a regenerator for various regenerator outlet temperatures (larger regenerator sizes result in a lower outlet temperature).

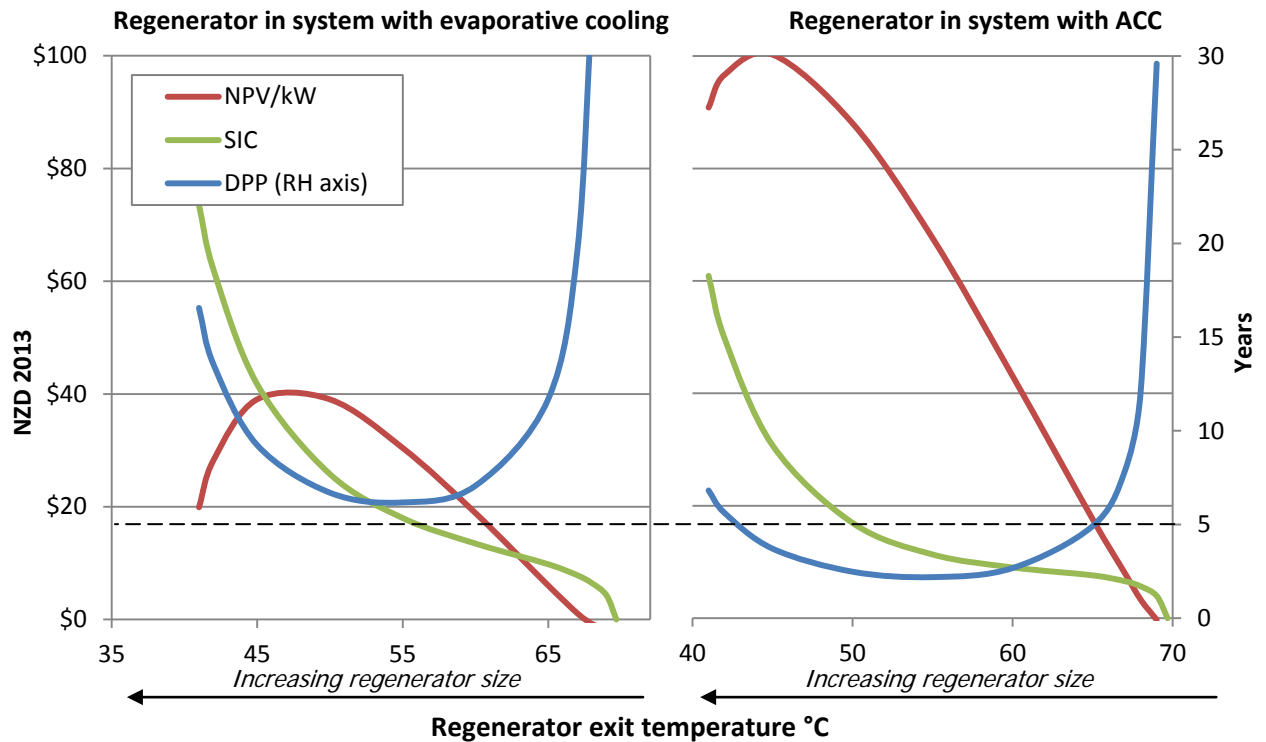

**Figure 3.13: The SIC, NPV/kW, and DPP for an investment into regenerator for the geothermal case modelled in EES. The horizontal line indicates the estimated DPP for the entire ORC system without a regenerator.**

Figure 3.13 shows how the size of the regenerator changes the economic performance of the system. There exists an optimum size of regenerator such that the each economic measure is best improved; a regenerator that is very small will not increase the SIC, but will also not improve the net power output, while a very large regenerator will be affected by diminishing returns while having a high SIC.

The optimal regenerator size in terms of minimum payback period is different to the size which maximises NPV/kW. This is because the inclusion of a regenerator provides ongoing benefits in the examined scenario, reducing parasitic loads and increasing the net system output. The DPP criterion only includes benefits up until the system has paid itself off, whereas the NPV/kW includes the benefits that accrue over the entire lifetime of the system (albeit at a discounted rate).

The effect that a regenerator's size has on its SIC varies, from a large increase with a sizeable regenerator, down to a negative increase for a very small regenerator. This is because the additional cost of a small regenerator is counterbalanced by the reduced initial cost of the condenser, ACC and evaporation equipment. One limitation of the model is that it does not include a fixed 'system reconfiguration cost', representing the additional fixed costs of the more complex, regenerative ORC system configuration.

Figure 3.13 indicates that the ORC system with ACC cooling receives a greater benefit from the inclusion of a regenerator than the system that uses evaporative cooling; the maximum NPV/kW return occurs at a much lower outlet temperature (larger regenerator size) for the ACC system. The additional cost of the regenerator also has a much shorter discounted payback period when placed in the ACC system. The inclusion of a regenerator will reduce the five-year payback of the overall ORC system for a wide range of sizes, acting to reduce the overall system payback period for outlet temperatures between 65°C (with a small regenerator) and 43°C (with a large regenerator).

### 3.5 ORC optimisation methodologies

In the previous section, several specific criteria were optimised in order to minimise the specific investment cost (SIC) of theoretical ORC system designs, and this optimisation was used to draw conclusions about ORC design in general. This section looks at other thermo-economic analysis in literature and a meta-analysis is performed to evaluate their value in ORC design.

#### 3.5.1 Thermo-economic evaluations in literature

In a seminal thermo-economic optimisation study for ORCs, (Quoilin et al., 2011) performed a thermo-economic optimisation for a theoretical WHR system with a 180°C heat source and a range of working fluids. A volumetric expander was used with a fixed pressure ratio. The evaporating temperature was varied (i.e. to represent adjusting the pump and expander speeds/torque) and large differences between Thermodynamic and thermo-economic optimums were found (Figure 3.14), leading to different fluid choices in some scenarios. The thermo-economic optimum evaporating temperature was higher than the thermodynamic optimum, unlike in the optimisation in Section 3.4.2. This is because the expander in the study by Quoilin et al. was modelled as a volumetric machine with a fixed expansion ratio.

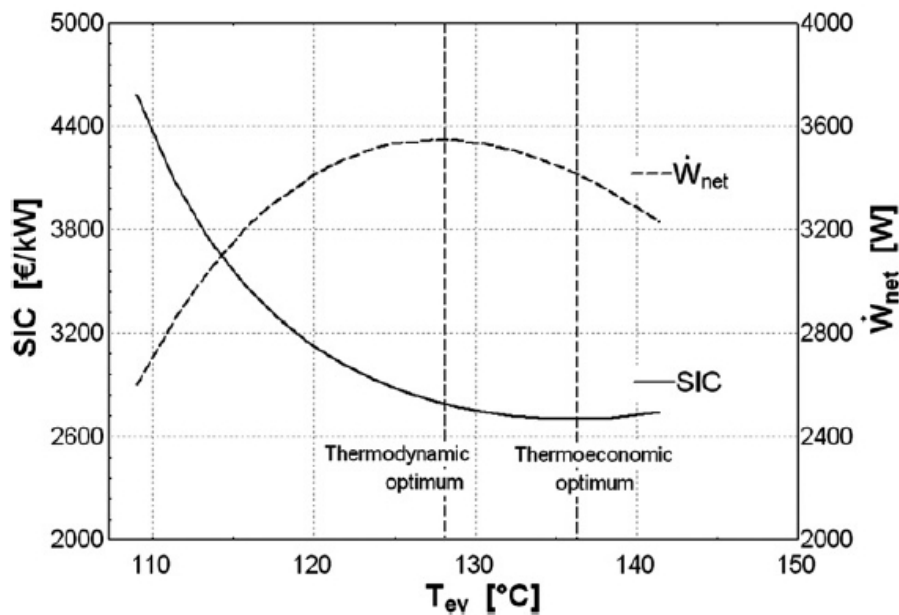

Figure 3.14: Specific investment cost and net power output vs. evaporation temperature for a considered system. Image Fig. 6 in 'Thermo-economic optimization of waste heat recovery Organic Rankine Cycles' (Quoilin, Declaye, Tchanche, & Lemort, 2011). Image reproduced with publisher's permission.

(Lecompte, Huisseune, van den Broek, De Schampheleire, & De Paepe, 2013) performed an analysis on a WHR ORC, fed by 85°C water from a CHP engine using cost functions from (Quoilin et al., 2011). A thorough economic model was prepared, including considerations for part-load performance due to both heat source mass flow, and ambient temperature variations. The study found that part load consideration increased the SIC by around 25% when compared to assuming constant design values.

(Li et al., 2014) performed a thermodynamic optimisation of a low temperature (120°C) geothermal system using range of working fluids, including a trans-critical CO<sub>2</sub> cycle with and without a regenerator. No lower temperature limit was placed on the geothermal fluid. The study found that the systems without a regenerator had lower SICs, and that the trans-critical CO<sub>2</sub> cycle had the lowest component costs, although it also provided the lower net power output.

In a recent study by (Calise et al., 2014) a thermo-economic optimisation was performed on a single ORC design with regenerator, working from 160°C thermal oil heat source with n-butane as the working fluid. The study used a fixed evaporation temperature and instead varied the heat exchanger shell diameter and tube length. The study found that the thermo-economic optimisation led to a 21% improvement in annual economic return over a system with nominal chosen geometric parameters.

A common aspect of all the mentioned studies is that they assume that operation and maintenance costs (except for parasitic loads) are fixed and use a minimum the specific investment cost (SIC) as the objective function.

### 3.5.2 Value of thermo-economic evaluation meta-analysis

In this section, a meta-analysis on the study by (Quoilin et al., 2011) is performed, in order to determine the effect that a thermo-economic optimisation (with minimal SIC as the objective function) has on various economic criteria.

The optimisation procedure in the Quoilin study uses the following assumptions;

- Plate heat Exchangers – the LMTD method for counter-flow heat exchangers was used to calculate the heat transfer. The pressure drop was calculated using the Thonon correlation. A 10°C PPTD temperature was imposed.
- Expander – a fixed volume expander with a set pressure ratio was assumed. Losses were lumped into a single mechanical efficiency of 80%.
- The pumps were modelled with isentropic efficiency of 60%.
- A minimum condensing temperature was imposed, and a minimum degree of superheat was chosen for non-dry working fluids.

The optimisation was performed along one degree of freedom by changing the evaporation temperature, and run for a range of working fluids. The results of the thermo-economic optimisation compared to a thermodynamic optimisation are shown in Table 3.9.

**Table 3.9: SIC, efficiency and output power from (Quoilin et al., 2011). Prices converted to 2013 NZD.**

	<b>At thermodynamic Optimum</b>	<b>At thermo-economic Optimum</b>
<b>ORC component SIC (\$/kW)</b>	5016	4898
<b>Total output power (kW)</b>	3550	3400
<b>System efficiency (%)</b>	5.13	3.69
<b>SPP (Years)</b>	5.30	5.18
<b>DPP (Years)</b>	6.31	6.14
<b>20 year NPV/kW</b>	Nominal	+\$118

Purely in terms of the investment cost, thermo-economic optimization is worth \$118/kW at the outlay of the system in this scenario. This saving per kW is maintained over the lifetime of the system, so that the NPV/kW remains \$118 greater for the thermo-economically optimised system at all points in time, regardless of the discount rate or electricity sale price, assuming that the O&M costs for both systems are the same.

However, when evaluating the total (not specific) NPV, an investment into the more expensive thermodynamic-optimum system appears to be preferable to the thermo-economically optimised system (Figure 3.15). This is because the thermodynamically-optimised system has a greater output power, improving the economics of the investment over time.

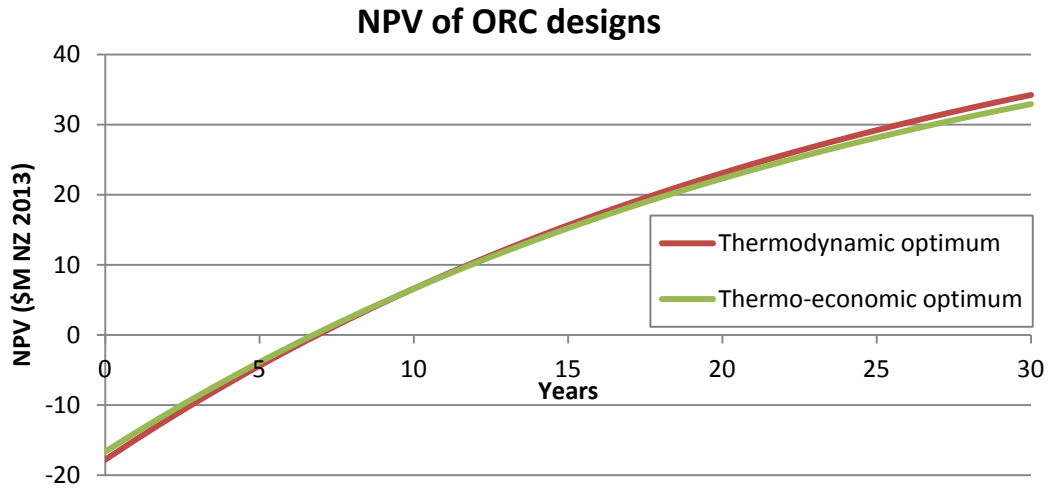

**Figure 3.15: NPV of thermo-economic and thermodynamic optimum systems. Nominal values for the capacity factor of 92%, a discount rate of 4%, annual O&M costs of \$350,000, and the electricity sale price of 12c/kWh for the lifetime of the system are assumed.**

The ‘thermodynamic optimum’ system surpasses the ‘thermo-economic optimum’ system in net profitability after ten years of operation, and so although the thermo-economic optimum system performs better under criteria such as SIC and DPP, it does not perform better in terms of NPV. This is an important distinction, as the more expensive, ‘thermodynamic optimum’ system generates a greater profit in the long-term; it may also generate a greater energy profit and improve the overall EROI.

The EROI of the thermodynamic and thermo-economic optimum systems were calculated using Equation 3.17 (based on the EROI Equation 2.2), and assuming 30 years of operation;

$$EROI = \frac{\Delta D'}{\Delta(S_{1d} + S_{1i})} = \frac{\sum_{i=1}^{30} 8766 \times P_{net} \times C}{e_{investment,ORC} \times I + \sum_{i=1}^{30} \$350,000 \times e_{maintenance,ORC}} \quad (3.17)$$

Where  $e_{investment,ORC}$  is assumed to be equal to 4.3 MJ/\$(NZ 2013), adapted from Table 2.3.

$e_{maintenance,ORC}$  is assumed to be equal to 2.8 MJ/\$(NZ 2013), adapted from Table 2.4.

$C$ ,  $P_{net}$ , and  $I$  are the assumed capacity factor of 92%, the net power output, and the initial investment cost as described in Equations 1.1 and 1.9.

Using the assumed criteria, the EROI for the ‘thermodynamic optimum’ system is found to become greater than the ‘thermo-economic’ system after 28 years of operation. Furthermore, the  $EROI_{annual}$  (Equation 2.5) of the ‘thermodynamic optimum’ system is greater than for the ‘thermo-economic’ optimum system, and so the gap in EROI will widen over time.

This example highlights the distinction between economic and energy criteria, and how investing in ORCs for economic wealth may not be preferable from an energy wealth point of view. Measures that can shift economic criteria to better reflect long-term energy wealth are explored further in Chapter 4.

## Chapter 4 – Implementation of ORCs into the wider economy

---

As identified in Section 1.5, the economic environment can have a significant effect on the economic performance of an ORC system. Chapter two showed that optimal economic performance and energetic performance are not always the same, linking good energetic performance to improved societal outcomes. Section 3.5 showed that systems designed to best achieve one set of economic criteria may be different to those designed for a separate set of economic criteria, and that a focus on short-term economic outcomes may lead to ORC designs that offer a relatively weak long term outcome from an energy point of view.

This chapter looks in more detail at the economic environment, how changes to it may affect ORC systems, and what external policy mechanisms can be used to best promote future energy wealth.

### 4.1 Electricity Price and seasonal performance

An important aspect of financing and investment into ORCs, especially for smaller or industrial investors, is the near-term return. One aspect that can affect the near-term return of all ORC systems is the annual performance variability as a result of cooling resource temperature changes throughout the day and the year. This factor is uniquely significant for ORC systems, as the temperature difference between heat source and heat sink is relatively low, so a temperature swing will have a greater proportional effect on performance than for high-temperature systems.

In New Zealand, wholesale electricity generation is sold on the spot market, which undergoes daily price fluctuations as demand changes, as well as seasonal price fluctuations throughout the year, largely along with the change in hydro lake storage capacity (Tipping J. P., 2004). The annual average spot price can also vary greatly between years, again as lake levels may be threatened by droughts, or as demand patterns change (Figure 1.6).

In this section, the interaction between daily and seasonal electricity price and ambient temperature is investigated, to determine the effects that these may have on the expected performance of a low-temperature ORC system. This is used to determine whether a seasonal adjustment factor should be added to annual return estimation formulas, such as Equation 1.9, in order to more accurately estimate the return for ORCs in the New Zealand electricity market;

$$R_t = S \times 8766 \times P_{net} \times P_r \times C \quad (4.1)$$

Where  $S$  is the seasonal adjustment factor, chosen depending on the ORC evaporation temperature.



#### 4.1.1 Analysis setup

The analysis was performed by calculating the return for a model system at every hour of the year for nine years, from November 2001 until November 2010, using real weather and spot price data (Equation 4.2).

$$R_t = \sum_{i=1}^{8766} P_{net,i} \times P_{r,i} \quad (4.2)$$

Where  $P_{net,i}$  is the average net electrical output of the system in hour  $i$  (kWh)

$P_{r,i}$  is the average electricity final sale price in hour  $i$  (kWh).

For the electricity sale price, a dataset of the half-hour final prices at the Whakamaru or WKM node was used. These prices were made available by the market distributor M-Co and converted into a format suitable for research by Geoffrey Pritchard (Pritchard, 2011). This node was chosen as it is located in the Taupo Volcanic Zone, near the majority of New Zealand's geothermal development. The average monthly and hourly final prices were calculated from this dataset. Gaps in the data were filled in using the average price for the corresponding hour from the previous and subsequent days.

For the weather data, a dataset of the hourly wet and dry-bulb temperatures at the nearest available location, Taupo airport, was used. This data was obtained from the National Institute of Water and Atmospheric research CLiFlo database (NIWA, 2015). Gaps in the data were filled in using the average temperatures of the previous and subsequent hours. The distance between the Taupo airport weather station and the Whakamaru power station is roughly 50 km.

Water temperature data was also used for a theoretical plant with once-through cooling. Data was obtained for the average monthly water temperature of Lake Tarawera in the Bay of Plenty from the Bay of Plenty district council for the year of 2013 (Bay of Plenty Regional Council, 2014). In order to investigate the most extreme possible variations, temperatures from a very shallow depth of 0.5 m was used. It was assumed that the timing and magnitude of Lake Tarawera's temperatures variations are also representative of lakes closer to Whakamaru.

In order to calculate the hourly return, a theoretical ORC system with closed-loop evaporative cooling was modelled using the following assumptions;

- Negligible superheating and subcooling.
- For the initial study, a capacity factor of 100% is assumed, and so the time of scheduled maintenance is not chosen.
- The cooling fluid temperature rises by 6°C in the condenser ( $T_{c,out} - T_{c,in} = 6$ ).
- For an evaporative cooling process, the condenser water outlet (cooling tower inlet) temperature is determined by Equation 4.3 (Engineering Toolbox, 2010);

$$T_{c,out} = T_{wb} + \frac{T_{c,out} - T_{c,in}}{\varepsilon} = T_{wb} + 8 \quad (4.3)$$

Where;  $\varepsilon$  is the adiabatic effectiveness of the cooling tower. This is assumed to be 75%.

$T_{wb}$  is the wet-bulb temperature.

- For the air and once-through water cooled systems, the condenser cooling fluid inlet temperature was assumed to be the measured dry-bulb and water temperature respectively.
- The hourly overall system efficiency was estimated using Equation 4.4, given for the approximate efficiency of binary power plants with resources temperatures between 100-140 in (DiPippo, 2007);

$$\eta_{total} \cong \frac{T_H - T_{c,in}}{T_H + T_{c,in}} \quad (4.4)$$

Where  $T_{c,in}$  is the cooling fluid condenser inlet temperature in Kelvin.

$T_H$  is the heat source temperature in Kelvin.

#### 4.1.2. Daily price variation

The per-hour average electricity price and power output for a system with evaporative cooling is shown in Figure 4.1;

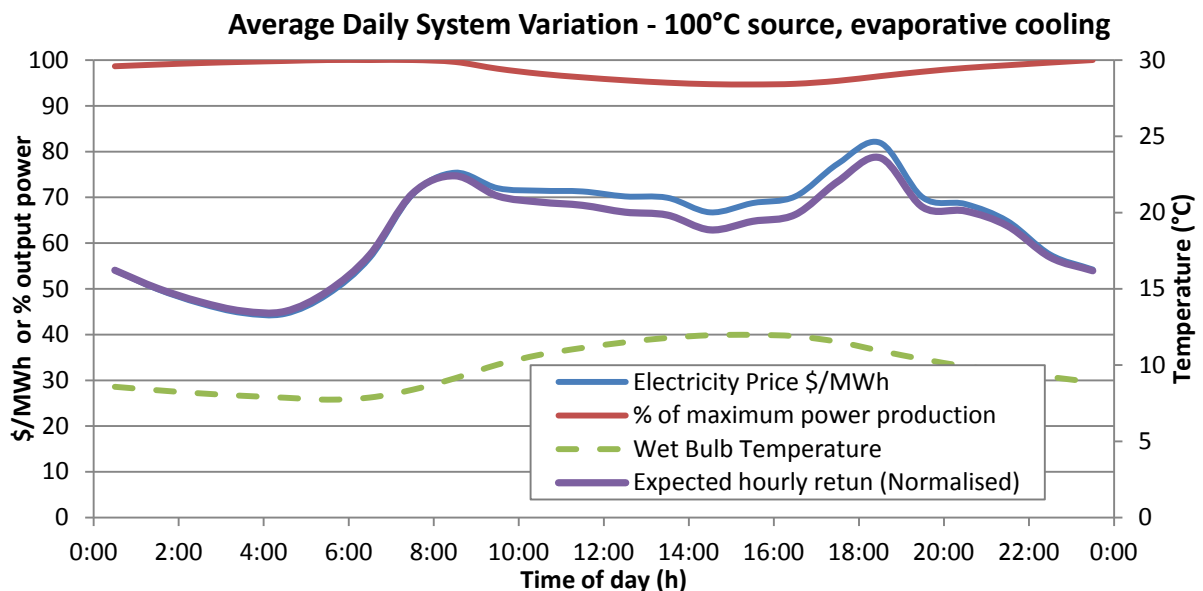

**Figure 4.1: Average hourly temperature, power production, and final electricity price at WKM node for all hours included in the study between November 2001 and November 2010. A heat source of 100°C and evaporative cooling is assumed.**

Figure 4.1 shows that, on average the system with evaporative cooling generally produced less power between the hours of 9:00 am to 8:00 pm. Except for the early morning peak from 7:00 am to 9:00 am, these hours roughly coincided with when the spot price was at its highest. The net effect of this is a slight reduction in actual revenue generated, below the nominal case (where the annual average prices and power outputs were assumed), of 0.73%. With air cooling, the efficiency reduction was slightly more pronounced, as the dry-bulb temperature underwent slightly greater daily variations. An hour-by-hour analysis was not run for the system with water cooling, as the lake temperature did not vary significantly throughout the day.

### 4.1.3. Monthly price variation

Figure 4.2 shows the per-month average variation in spot price and power output for a theoretical ORC system with a 100°C heat source and evaporative cooling.

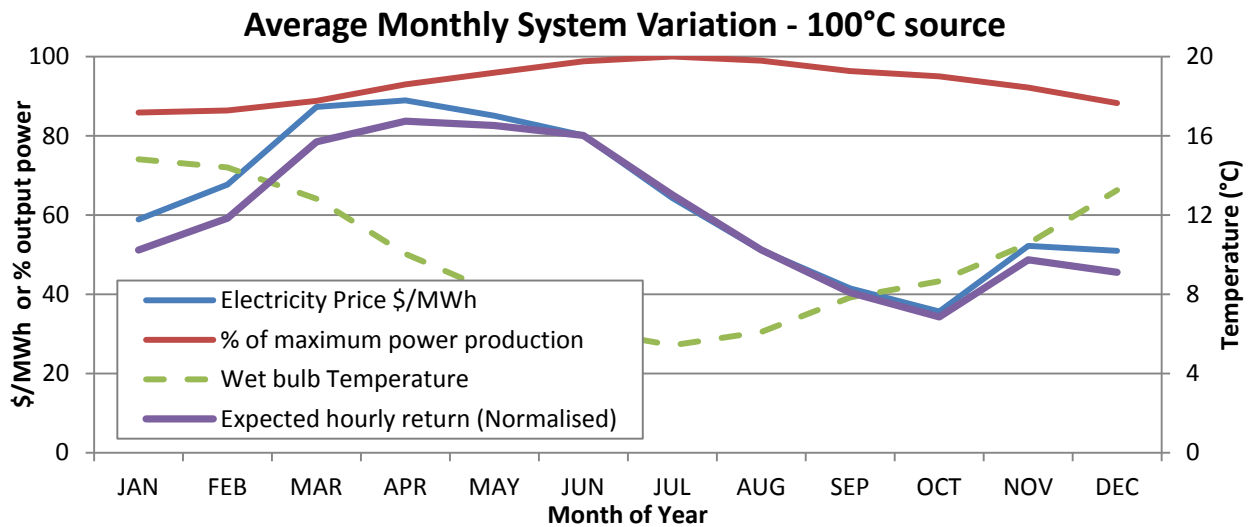

Figure 4.2: Average monthly temperature, power production, and final electricity price at WKM node for all hours included in the study between November 2001 and November 2010. A heat source of 100°C and evaporative cooling is assumed.

Figure 4.2 shows that, on average the system with evaporative cooling generally produced less power in the summer months than in the winter months. Overall, the spot price was higher in months of average and low production than in the months of maximum production. The net effect of this is a slight reduction in actual revenue generated, below the nominal case (where the annual average prices and power outputs were assumed), of 0.71%. A similar yet slightly more pronounced trend was observed with the air-cooled system model.

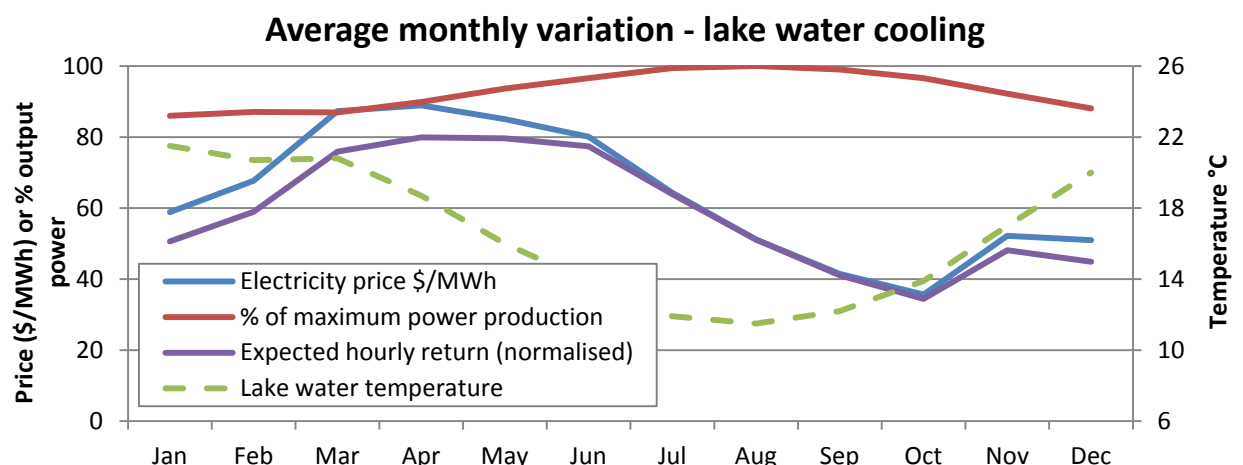

Figure 4.3: Average monthly temperature, power production, and final electricity price at WKM node for all hours included in the study between November 2001 and November 2010. A heat source of 100°C and once-through water cooling is assumed.

As indicated in Figure 4.3, the lowest lake temperatures (and therefore the maximum system efficiencies) occur about three weeks later in the year than the lowest air temperatures. This shifts the dynamic between the seasonal price and the system efficiency, compared to the systems with evaporative water and air cooling.

#### 4.1.4. Summary of daily and seasonal return correction factors

**Table 4.1: Change in expected returns for an ORC system using detailed analysis versus using annual average prices and efficiencies, for systems with a 100°C heat source.**

Analysis type	Cooling Type		
	Air	Evaporative water	Once-through water
Hourly	-0.91%	-0.60%	N/A
Monthly	-0.82%	-0.54%	-0.46%

Table 4.1 shows that a more detailed level of analysis does not significantly change the returns expected from low-temperature ORCs, regardless of cooling type. In all cases more detailed price analysis worked to reduce the estimated returns. The results obtained by using average monthly temperatures and electricity prices were very similar to the results using hourly calculations. This indicates that for a New Zealand scenario, using annual averages such as in Equation 1.9 does not result in a significant under or over-estimation of the economic returns from low-temperature ORC systems. More detailed analysis using monthly averages should provide a closer estimate to the real returns, but there is little additional potential accuracy to be gained from more computationally-intensive hourly returns calculations.

A table of ‘seasonal adjustment factors’ (Equation 4.1), based on the model results for different heat source temperatures, is included in the appendix (Table A4.1).

#### 4.1.5. Economic capacity factor

A typical capacity factor for geothermal and WHR ORCs is about 92% (Table 1.7). Often, the majority of lost capacity is due to scheduled maintenance. For larger power generation systems, this is often timed in New Zealand to occur during September – October, when the electricity price is on average lowest (Figures 4.2 and 4.3).

This practise can act to increase the annual economic return that a system offers, beyond what is represented by the traditional capacity factor (as in Equation 1.9). A study was made to determine the 'economic capacity factor' (Equation 4.5), which accounts for how generators can utilise the seasonal swings in average electricity price;

$$R_t = 8766 \times P_{net} \times P_r \times C_e \quad (4.5)$$

Where  $C_e$  is the economic capacity factor.

This is the fraction of economic return compared with the potential return if the plant was running at design conditions continuously. It is assumed that the maintenance schedule can be chosen. The return was calculated using a theoretical ORC system as described in Section 4.1.1, and the hourly spot price. A heat source of 100°C and evaporative cooling was assumed.

A 92% capacity factor correlates with 29.2 days of scheduled maintenance (in a non-leap year). The 29.2 day period of lowest returns was found to occur from the 28<sup>th</sup> of September until the 27<sup>th</sup> of October. If the maintenance were to be able to be scheduled for this time, then 95.8% of the possible annual return could be made. I.e. the economic capacity factor  $C_e$  is 0.958 when the capacity factor,  $C$  is 0.92, if all shut-downs can be time to occur during an annual scheduled maintenance period.

## 4.2 ORC cost sensitivity to material prices

For all ORC systems, a significant proportion of the system cost goes towards purchasing heavy components (Section 3.1). Most of these components are typically made with a large proportion of metals such as steel, aluminium, and copper. In this Section, an investigation is made into the interaction between ORC prices, metal prices, and the crude oil price, to determine the interrelations of all these markets, as well as the vulnerability that ORC systems may have to large swings in these raw material prices (Kreith, 2013).

ORC systems appear to require similar weights of concrete and steel (Table 4.2). As concrete costs-per-weight tend to be about an order of magnitude lower than steel and other metals (Calin M. Popescu 2003), this analysis focuses on the total metal prices.

### 4.2.1. Metal weight in ORC systems

Several case studies were used to determine the weight of ORC systems, one life-cycle analysis and two simple, system-only cases. Table 4.2 shows the estimated material weight per kW of a binary geothermal system, as found by an 'infrastructure stage' life cycle cost analyses (LCA) undertaken for the U.S Department of Energy (J.L. Sullivan, 2010). In the LCA analysis, the direct material use, as well as the material use required for parts manufacture, was considered.

**Table 4.2: Material weights per-kW for a 10 MW binary plant system with an assumed lifetime of 30 years and a resource temperature between 150 – 185°C. The steamfield is assumed to contain 1000 m of piping and the wells are assumed to total 1500 m deep. Data adapted from Table 2a in 'Life-Cycle Analysis Results of Geothermal Systems in Comparison to Other Power Systems' (J.L. Sullivan, 2010).**

<b>Material</b>	<b>Plant (kg/kW)</b>	<b>Steamfield (kg/kW)</b>	<b>Wells (kg/kW)</b>
Aluminium	46.1		
Concrete	459		
Cement		16	71.7
Bentonite			34
Iron	4.28		
Steel	231	16	109
<b>Total</b>	<b>740.38</b>	<b>32</b>	<b>214.7</b>

In order to provide further points for comparison of material weights / kW, a study was made into two smaller ORC systems. These weights simply considered the actual materials in the final plant equipment, and not the additional material use during manufacturing. As a result, it is expected that these specific weights will be less than what was found in Table 4.2.

An experimental 1kW system, titled the 'ORC-C' at the University of Canterbury (Michael Southon, 2014) was found to have a specific weight of 109.4 kg/kW, with the majority of the weight being from steel components. A summary of the component weights and major material groups are listed in Table A4.2. It should be noted that the included weights are for the installed plant components only, and not the heat source systems or the building foundations.

The Second system for comparison is the UTC PureCycle 280 system. If this system were installed on a 99°C heat source, it is expected that it will provide roughly 210 kW net electricity (White, 2009). From the system brochure, the core system (excluding ACC or heat source connection equipment) has an estimated installed weight of 15.1 tonnes (UTC Pratt & Whitney, 2009). This gives an estimated specific weight as 71.9 kg/kW. The actual material composition of this weight is unknown, so an average ratio between aluminium and steel was assumed from the other two cases.

A summary of the main metal groups, and their estimated minimum-processed material prices are listed in Table 4.3 below;

**Table 4.3: Estimates for plant-only material weights. Estimated primary metal costs indicative only, averaged from the London Metal Exchange (LME, 2015), and (SteelBenchmarker, 2015).**

<b>System</b>	<b>Steel (kg/kW)</b>	<b>Aluminium (kg/kW)</b>
10 MW Binary	231.0	46.1
210 kW Geothermal surface water	62.9	9.0
1 kW experimental	100.3	9.1
<b>Cost/kg (2014 USD)</b>	\$0.55/kg	\$2.75/kg
10 MW Binary	\$127/kW	\$126/kW
210 kW Geothermal surface water	\$35/kW	\$25/kW
1 kW experimental	\$55/kW	\$25/kW

As expected, the material weights of the case study systems were below the weight determined by LCA analysis. As such, the weight / kW presented by the LCA-analysis can be considered to be a suitable best estimate for further analysis. Assuming that the relative price changes are equal across metals, changes to the metal price would affect the SIC of an ORC system as shown;

$$\Delta SIC = \Delta metal price(231 \times Steel Price + 46.1 \times Aluminium price) \quad (4.6)$$

If the prices listed in Table 4.3 are assumed to be an accurate direct material cost, then changes to the metal price could be expected to change the SIC by a fixed amount. For example, changes to the material price will change the cost as shown in Equation 4.7;

$$\Delta SIC = \$253 \times \Delta metal price (at early 2015 prices) \quad (4.7)$$

#### 4.2.2. Metal price variation

The actual price variation of metals is indicated in the International Monetary Fund (IMF) metal price index. This index includes costs from a selection of major metals including iron and aluminium. It was assumed that this index can be reasonably used to represent the long-term price fluctuations for the metals in ORC systems. Figure 4.4 shows the variation in price indices for metals, crude oil and HVAC/R equipment manufacturing in the US (NAICS sector code 333415) from 1985 until the beginning of 2015.

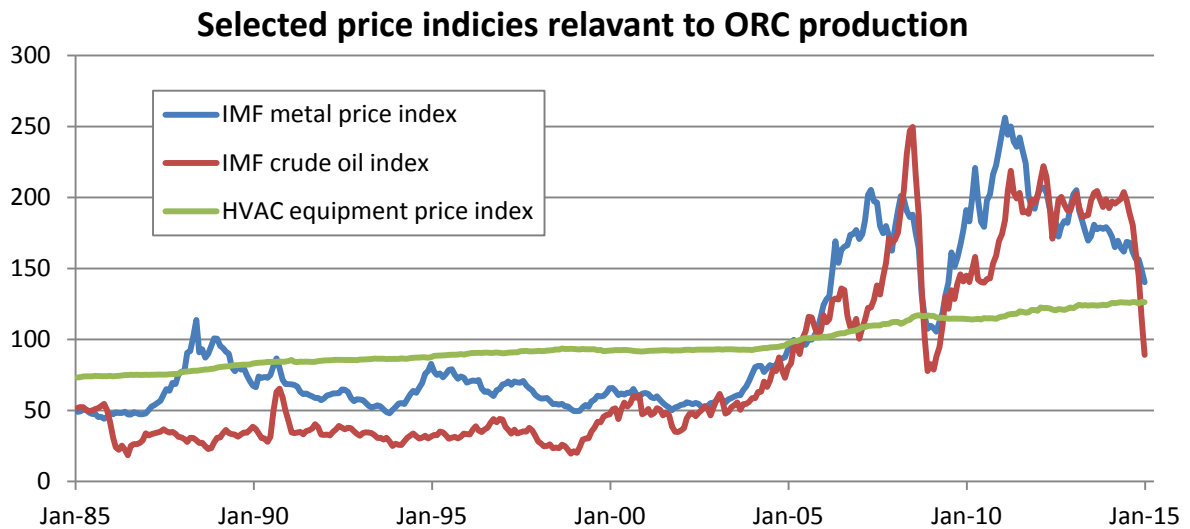

**Figure 4.4: Real price indices for metals, crude oil, and US HVAC equipment manufacturing (Full title 'Air-conditioning and warm air heating equipment and commercial and industrial refrigeration equipment manufacturing'). Index values from (IMF, 2015) and (Statistics, 2014). Indices have been adjusted so that the 2005 average = 100.**

It can be seen from Figure 4.4 that in the past, metal prices have risen sharply over time. This roughly coincides with the increase in the crude oil price. From August 2002 until April 2011, the metal price index increased by 380% from 52.4 to 250.1. If a price increase of this magnitude were to again occur at the assumed current raw-material prices (Equation 4.7), it would increase the ORC price by \$960 USD / kW.



### 4.2.3. Price index correlation

Although the HVAC/R index does not explicitly include ORC systems, refrigeration equipment uses very similar components to ORCs, especially small-scale systems (UTC Pratt & Whitney, 2009). The movement of the HVAC/R equipment price index is assumed to be equivalent to an ORC price index in this section.

The relationship between the index prices of metal, crude and HVAC/R equipment was evaluated using the Pearson's product-moment coefficient for a sample (commonly called correlation coefficient, or r-value);

$$r_{xy} = \frac{\sum_{i=1}^n (x_i - \bar{x})(y_i - \bar{y})}{\sqrt{\sum_{i=1}^n (x_i - \bar{x})^2} \sqrt{\sum_{i=1}^n (y_i - \bar{y})^2}} \quad (4.8)$$

Where  $\bar{x}$  and  $\bar{y}$  are the means of the variables  $x$  and  $y$  respectively

The correlation coefficient was calculated between each of the three indices shown in Figure 4.4. In order to account for the time-delay of any possible correlations, the indices were also shifted relative to each other to determine across what time difference the strongest correlations are achieved. This is shown in Figure 4.5.

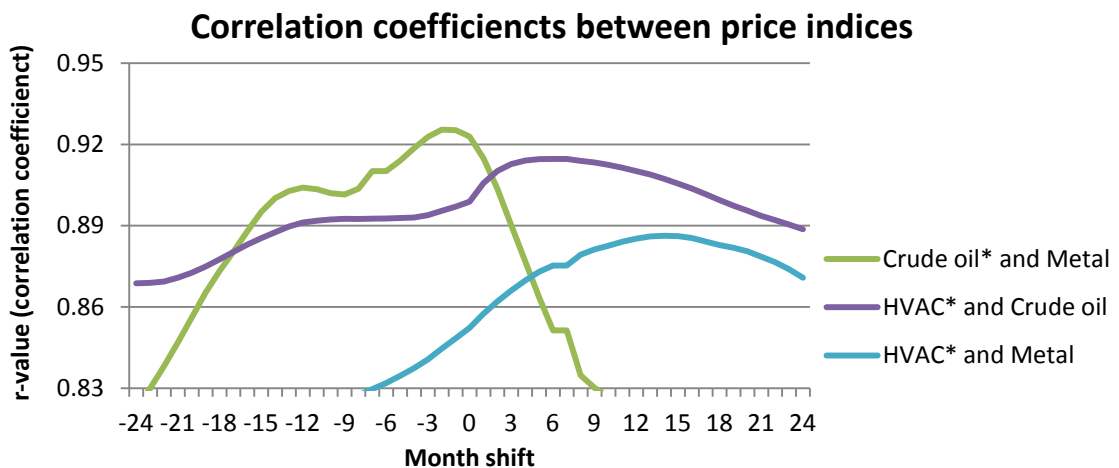

**Figure 4.5: Correlation coefficient for crude oil and metals, HVAC/R and crude oil, and HVAC/R and metals price indices. The items in the legend indicated with an asterisk were anchored, while the other indices were shifted forward and back by one-month intervals to determine the effect on the correlation coefficient.**

The correlation coefficients are all reasonably strong, with all the relationships having a correlation above  $r = 0.88$  with some amount of time shifting. This does not mean that a shift in the price of one commodity will cause a change in another, but merely that shifts tend to occur at similar times and be of similar magnitudes.

Over the period of sharp metal price increases from August 2002 until April 2011, the HVAC index increased from 92.9 to 117.9, a 27% increase. If this were to occur again at early 2015 prices, a nominal \$4000/kW ORC system would increase by \$1,080/kW. This is a very similar estimate to the potential ORC price increase calculated from metals prices in Section 4.2.2.

## 4.3 Discount rates and subsidies

### 4.3.1. Effect of discount rates on investment outlook

In investment analysis, a discount rate is used to account for the time value of money. It is applied to many common formulas that are used to evaluate potential investments, such as the NPV, DPP and the LEC (Equations 1.3, 1.5 and 1.8). The actual value given to discount rates varies between applications, usually ranging from 5-10% for business investments (Section 4.3.2).

The choice of the discount rate can have a significant effect on the investment criteria's outcome. This is particularly true for investments where the majority of the lifetime cost is incurred before revenue has been generated, as is typical of renewable energy investments such as ORCs.

Figures 4.6 and 4.7 are contour plots indicating the payback period of a zero-fuel cost energy investment, for various specific investment costs (SICs) and electricity sale prices. The following criteria are assumed;

- An annual operation and maintenance cost equal to 4% of the capital cost. This is assumed to remain constant throughout the lifetime of the project.
- A 92% capacity factor.

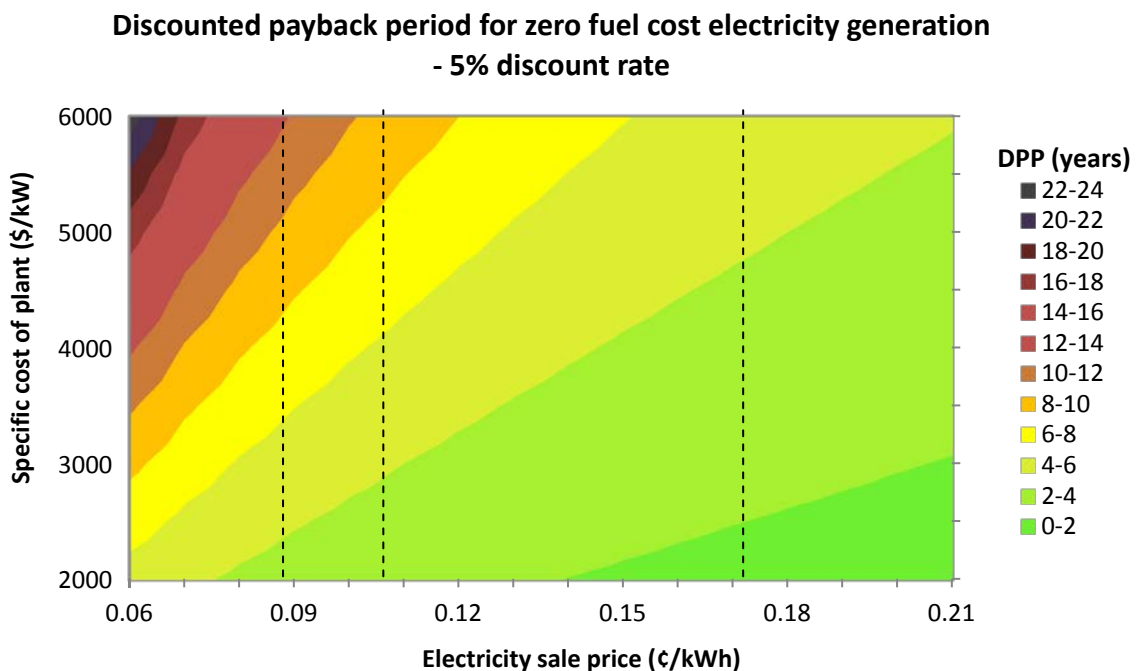

**Figure 4.6: Contour plot showing the discounted payback period for an investment into electricity generation equipment, assuming a 5% discount rate. The 2012 average wholesale, industrial and commercial electricity prices for New Zealand are indicated. NZ prices from (Pritchard, 2011), (NZ Electricity Authority, 2013) and (MED (NZ), 2015).**

Figure 4.6 can be used to indicate the range of SICs that could be considered 'economic' for a given electricity price. For example, the figure shows that the range of SICs that a New Zealand industrial buyer could pay for an ORC system if they are wishing to achieve payback within 4-6 years is between \$2,800 and \$4,100, whereas a commercial buyer could achieve that payback at a much higher price, from \$4800 - \$7000.

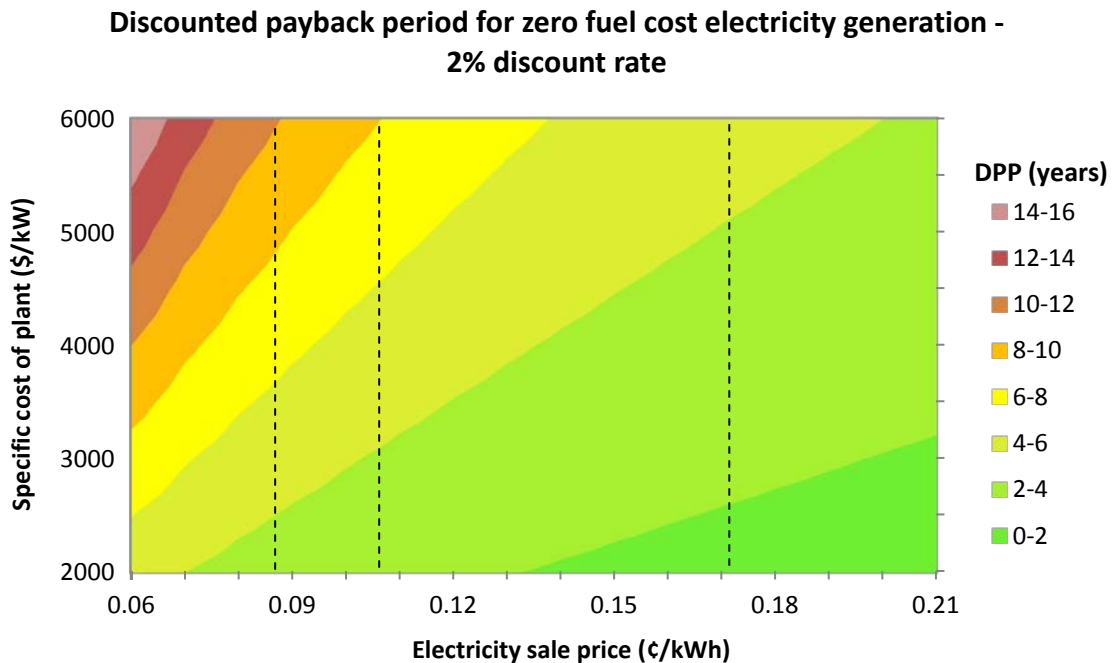

**Figure 4.7: Contour plot showing the discounted payback period for an investment into electricity generation equipment assuming a 2% discount rate. 2012 average wholesale, industrial and commercial electricity prices for New Zealand are indicated. NZ prices adjusted from (Pritchard, 2011), (NZ Electricity Authority, 2013) and (MED (NZ), 2015).**

Figure 4.7 shows contour plot of DPP relative to SIC and electricity price, with an assumed discount rate of 2%. Under this criteria, the range of SICs that a New Zealand industrial buyer could pay for an ORC system if they are wishing to achieve payback within 4-6 years now increases over the 5% discount rate case by \$400/kW, to between \$3,200 and \$4,500. A commercial buyer can now instead achieve a 4 to 6 year payback at SICs between \$5,200 and \$7,600. The 3% decrease in discount rate has resulted in an increase in acceptable investment costs of roughly 10%.

### **4.3.2 Social and company discount rates**

#### ***Social discount rates***

The discount rates applied to nationally funded projects tend to be lower than company discount rates. In the U.S., the recommended discount for national energy projects was 6.6% in 1994 (Peterson, 1994). More recently, lower rates have been used by the U.S Department of Energy, with the official (real) rate in 2014 sitting at 3.0% (Rushing A.S., 2014).

A famously low discount rate of 1.4% was used in the Stern review on the economics of climate change (Stern, 2006). Lord Stern has since revised this number to 2.6%. This report and others used a 'social discount rate' for assessing the value of investment decisions on systems that affect the whole of society, such as the climate.

Arguments have since been made to use a lower rate still, or a negative rate when assessing investments that will have an effect on long-term variables such as the climate (Fleurbaey, 2012-2013). This argument considers the climate as a system from which there is a diminishing ability to extract utility over time, given current conditions.

#### ***Company discount rates***

In contrast to this, company discount rates are usually higher. A common method for basing a company discount rate is to use the weighted average cost of capital (WACC), which reflects the opportunity cost of making an investment (Oxera, 2011; Poterba J. M., 1995). This rate is then often added to by about 3-5%, depending on the investment to account for risk, creating a 'hurdle rate' (Iwan Meier, 2007). The resulting typical (real) company discount rate usually is somewhere between 5% and 15% (Mendelsohn M., 2013), about 5% higher on average than social discount rates.

### 4.3.3. Subsidy level required to achieve social discount rates

Subsidy types that have been granted towards ORC generation systems include feed-in-tariffs (an additional price for electricity from certain technologies, Table A1.2 part 2), capital grants/low interest loans (Holdmann, 2007; Reisenhofer, 2002), and the use of a CO<sub>2</sub>-price to deter fossil fuel-based alternatives (Europa, 2015).

A theoretical example case was set up in order to compare these economic interventions, and the magnitude of each option necessary to shift the outcomes of investment criteria to mimic a shift from the company discount rate to a social discount rate. The magnitude of the shift in discount rate required is assumed to be 5% (nominally a shift from 8% to 3%).

In the example case, two generation options were modeled, roughly representing new binary and coal electricity generation options in New Zealand, built on existing resources. The detailed economic criteria of both options are shown in Table A4.3. The electricity sale price was set to 8 ¢/kWh with 1% escalation per year, roughly in accordance with the predictions in (MED(NZ), 2013). Under these criteria, the option representing binary generation begins to have a greater 30-year NPV and smaller LEC if the discount rate is reduced below 3%. At an 8% discount rate, the option representing coal generation has an NPV/kW \$1490 greater, and a LEC 1.64 ¢/kWh less than the binary option.

Three economic intervention options are modeled with an 8% discount rate applied. Each intervention is given a total lifetime budget (cost) of \$1500/kW net capacity (this cost is assessed with a 3% social discount rate). The Feed-in-tariff option is modeled as being spread over the first ten years of operation, with the relative proportion in spending decreasing by 10% of the original value each year. The CO<sub>2</sub> price is charged on the emissions difference between the two options. The maximum budget (cost) criteria results in a CO<sub>2</sub> price of \$12.41/tonne.

**Table 4.4: Investment metrics evaluated under various economic interventions for two model plants; coal, and binary geothermal. Economic conditions as outlined in Table A4.3. All intervention types are priced so as to have a \$1500/kW total cost.**

	NPV/kW	DPP	LEC (¢/kWh)
<b>Base Case (8% discount rate)</b>			
'Coal' option	46	29.1	8.83
'Binary' option	-1444	Never	10.47
<b>With feed-in-tariff</b>			
'Binary' option	-447	Never	8.82
<b>With capital subsidy</b>			
'Binary' option	593	23	8.23
<b>With CO<sub>2</sub> price</b>			
'Coal' option	-816	Never	9.80
<b>3% discount rate</b>			
'Coal' option	3116	14.9	7.15
'Binary' option	3126	19.2	7.19

A capital price subsidy was found to be the only subsidy type that resulted in binary generation becoming more competitive than coal generation under all the economic criteria included in Table 4.4. The next most competitive intervention was the feed-in-tariff, which successfully reduced the LEC below that of coal generation, but still resulted in the binary system having a lower NPV. The CO<sub>2</sub> price came close to making the binary plant appear to be the more desirable option, but a CO<sub>2</sub> price above the maximum budgeted of \$21.50/tonne would have been necessary before this became the case.

The model results showed that interventions must be of a significant magnitude in order to emulate the effect of a switch from a typical company discount rate to a social discount rate. In the model, the smallest intervention option that could achieve a change in choice (based purely on money terms) is a \$1098/kW subsidy towards the capital cost of the binary plant.

## 4.4 GHG Pricing and ORCs

An important aspect of current and future electricity production is examining the cost of greenhouse gas (GHG) emissions (Figure A4.1). In this section, future potential GHG regulatory environments and their effect on ORCs are explored. Different regulations, all possible in the coming decades, can lead to very different potential markets and recommended approaches for a potential ORC manufacturer.

### 4.4.1 CO<sub>2</sub> emissions from ORC electricity

#### ***Emissions from geothermal, biomass and concentrated solar ORCs***

Due to the similar way in which the two system types harvest and use their energy resources, the CO<sub>2</sub> emissions intensity for geothermal, biomass and solar ORC units can all be expected to be similar to the emissions from equivalent steam-Rankine cycle systems. A guideline for the average lifetime CO<sub>2</sub> emissions per kWh of various electricity sources is shown in Table A4.3. This table uses CO<sub>2</sub>/kWh data obtained from (Schlömer S., 2014) for the IEA fifth assessment report.

The lifetime CO<sub>2</sub> cost of biomass electricity is highly situation-dependant. Investigations of weather biomass can be a carbon-neutral and environmentally sustainable fuel have lead to a variety of conclusions (MEEA, 2009; Saidur, Abdelaziz, Demirbas, Hossain, & Mekhilef, 2011). These reports indicate that the potential renewability of this resource depends heavily on the ability of economies to provide sustainable forest management; the direction land use change is occurring (i.e. clearing forests for wood, or switching grazing farmland to planted forests), the time-scale of sequestration and harvesting, and the potential efficiency of forestry, wood processing, and delivery processes.

Two values for the CO<sub>2</sub> emissions from biomass electricity are therefore included in Table 4.5. One estimate, from (Weisser, 2007) considers the potential re-sequestration after forests have been regenerated. The second estimate, titled 'biomass – dedicated electricity' in Table 4.5, does not include this re-sequestration.

#### ***Estimated CO<sub>2</sub> emissions from waste-heat recovery ORCs***

A WHR-ORC has no ongoing fuel costs, and so all of the CO<sub>2</sub> emissions from a WHR plant are embodied in the capital, operation and maintenance costs. The lifetime CO<sub>2</sub>e/kWh can therefore be expected to be somewhere between onshore wind power and concentrating solar (1.3%-3.3% of pulverized coal), as WHR plants generally cost somewhere in between these two plant types. The CO<sub>2</sub>e emissions from WHR may however be higher than this in situations where the process providing the waste heat has to be changed to accommodate the heat extraction, such as requiring additional heat or increasing fan power, although this is unlikely to be significant.

Table 4.5 shows a summary of the estimated emissions intensities of ORC electricity resources, with emissions intensities from pulverised coal and gas-turbine plants for comparison.

**Table 4.5: Estimated lifetime gCO<sub>2</sub>e/kWh of ORC resources (Schlömer S., 2014) and (Weisser, 2007). The ‘%’ column indicates the relative median emissions intensity for each technology when compared to pulverized coal. The ‘cost’ column is the resulting cost in cents/ kWh for a carbon price of \$25/tonne CO<sub>2</sub>e.**

<b>Commercially Available Technologies</b>	<b>Min</b>	<b>Median</b>	<b>Max</b>	<b>%</b>	<b>c/kWh</b>
<b>ORC resources</b>					
Geothermal	6	38	79	4.6	0.10
Biomass – dedicated electricity	130	230	420	28	0.58
Biomass after re-growth	35	70	99	8.5	0.18
Concentrated Solar Power	8.8	27	63	3.3	0.07
WHR-ORC (Estimated)		20		2.3	0.05
<b>Fossil-fuel plants</b>					
Coal - pulverised burner	740	820	910	100	2.05
Gas - CCGT	410	490	650	60	1.23

It is clear that all common ORC-resources have a comparatively low CO<sub>2</sub> output, and so will become relatively more competitive under CO<sub>2</sub> pricing set to target the combustion of fossil-fuels.

Geothermal, WHR and CSP can all be expected to produce CO<sub>2</sub> at a rate less than 5% of a pulverized-coal plant. Biomass-ORC systems have slightly higher emissions intensity due to the ongoing fuel costs of harvesting, processing and transporting the fuel, but they still compare favourably to coal and gas electricity. Depending on the type of any land-conversion used for biomass fuel, a CO<sub>2</sub> price may heavily impact the cash flow of a biomass electricity operation in the short and medium term, but this is highly site-specific.



#### **4.4.2 Current regulatory environment in New Zealand**

In New Zealand, GHG emissions are taxed under an Emissions Trading Scheme (ETS). The ETS aims to reduce GHG emissions down to 1990 levels. Currently it does this by requiring the purchase of permits for some emissions, which can be bought domestically or traded internationally. All emissions are measured in CO<sub>2</sub>-equivalents, which have a value proportional to the global-warming potential (GWP) of a substance. The amount that this regulation can potentially affect an ORC electricity generation system depends on the heat resource used (Section 4.4.1).

##### ***ETS in the geothermal sector***

A geothermal electricity producer has to join the ETS if it is producing 4000 tonnes or greater of CO<sub>2</sub> (equivalent) emissions per year (Ministry for the Environment, 2012a). Using the geothermal CO<sub>2</sub>e emissions intensities in Table 4.5, a geothermal producer can expect to pass this threshold at capacities somewhere between 5.8 MW – 76.0 MW. Some outlying cases may meet the threshold at lower generation capacities than this, such as the Ngawha geothermal field in Northland, New Zealand, which has been reported to release 597 gCO<sub>2</sub>/kWh (NZGA, 2012). A new plant with high emissions intensity such as this would have to enter the ETS at sizes of 760 kW or above, potentially incurring a significant cost depending on the emissions price.

Using high-GWP HFCs in binary applications currently incurs a carbon cost during the initial importation of the product (Ministry for the Environment, 2013). This cost can be expected to remain relatively small compared to the competitive advantage offered by a CO<sub>2</sub> price. For example; the 10 MW Ngawha binary plant uses about 30,000 litres of liquid pentane working fluid (Graaf, 2014). If an equivalent plant utilised a high-GWP working fluid such as R245fa instead, then the fluid would have an estimated CO<sub>2</sub>e of approximately 38,560 tonnes. If a CO<sub>2</sub> price of \$25/tonne is assumed (much higher than early-2015 ETS prices), the use of R245fa would incur an emissions cost of \$483,585, adding approximately \$48/kW to the SIC of the binary plant.

##### ***ETS in the waste heat sector***

Waste-heat recovery ORCs are not expected to cause additional emissions, and may act as a net emissions sink if they reduce process emissions elsewhere. Generally, most WHR-ORCs are used to produce electricity, and so their savings through the ETS can be measured using the CO<sub>2</sub> proportion of the local electricity price. In countries such with low-carbon electricity such as New Zealand, this contribution can be expected to be relatively small.

### ***ETS in the biomass sector***

Pre-1990 forests are included in the ETS, whereas post-1989 forests can choose to opt-in (Environment, 2012b). As a result, if the demand for wood products were to reduce, then the ETS will act to discourage land clearance, favouring alternative wood uses such as biomass electricity. Forestry's inclusion in the ETS can also improve financing for biomass electricity projects from post-1989 forests.

### **4.2.3 Future CO<sub>2</sub>-regulatory environments**

#### ***Cooperative global regulatory environment***

If international climate negotiations eventually result in a global and binding GHG agreement, then an extensive market for the introduction of low-fossil energy can be expected. This type of regulatory action would be intended to result in significant reduction to global greenhouse gas emissions (Proost, 2013).

Under a binding global agreement, all countries have a similar interest in reducing their GHG emissions, and so market mechanisms such as a global market for carbon credits can be used more effectively. A binding agreement of this type can be expected to increase market confidence into investments that benefit from a GHG price (Oxera, 2011), as the fear of sanctions from all trading partners will help to ensure that no single country can exit on its own accord.

The first attempt at this type of agreement was the Kyoto Protocol, yet while the agreement was ratified by 191 countries, only 37 of them chose binding targets for the first commitment period (2008 - 2012) and 33 for the second (2013 - 2020) (UNFCCC). Those that have not chosen binding targets are able to freely exit the agreement. A global cap-and-trade scheme effective from 2020 was envisioned under the Washington Declaration to be the successor to the Kyoto protocol. This agreement will be sought at the 2015 United Nations Climate Summit in Paris.

In terms of ORCs (and other renewable electricity systems), a more cooperative global regulatory environment will increase the technologies' competitiveness compared to fossil-fuel based generation (Section 4.4.1). This will result in more incentives for individual countries to provide innovations and services to accommodate for ORC technology at competitive prices, such as a greater availability of heat exchangers able to capture acidic waste heat streams (Section 1.2.3 and (Baresi, 2014), helping to improve their technology and reducing manufacturing costs through economies of scale.

Global GHG regulations may also put upwards pressure on the price of producing ORC systems, due to the increased cost of steel and cement production and processing (a highly CO<sub>2</sub> intensive process in many countries), as indicated in Section 4.2. This will however also be true for all current competing electricity production technologies, while the competitive advantages will only exist for low-GHG technologies such as ORCs.

### ***Uncooperative global regulatory environment***

A discussion paper by a Belgian economist (Proost, 2013) investigates the situation where not all nations are signed on to legally binding GHG reduction, and how a single nation can best act in order to reduce global GHG emissions under these circumstances. Assuming that the price of limited carbon-producing resources such as oil and coal increase as the resources become scarcer, the paper argues that an unregulated nation will consume these resources until they become scarce and the price increases above the price of renewable electricity, whereupon the focus of investments will quickly switch (presumably at the cost of significant debt for the unregulated nation).

If this speculation were to be true, then in order to reduce global GHG emissions as much as possible efforts should be focused on reducing the cost of renewable energy technologies. A solution along these lines would benefit technologies such as ORCs, that have a large potential of marginally economic resources (Section 1.4.3), and some remaining room for technology-based price reductions.

## Conclusions and Outlook

In this thesis, a wide range of aspects associated with the performance and cost of ORC systems are investigated. With a focus on resource usage, the historic and current growth in ORC capacity is assessed, and the established and emerging resources and competing technologies are identified. ORC development opportunities both in New Zealand and internationally are explored, and promising resources and technologies are assessed against historical and forward-looking criteria. A wide variety of ORC system types are assessed against energy and economic criteria, and guidelines for biophysical and economic wealth identified. Lastly, the role of the market systems in which ORC technology sits are considered, and the effects of potential future changes to these systems explored.

Using surveys of existing and potential ORC development, it is found that the resources that offer the most significant development opportunities for ORCs, with the least competition from other technologies, are distributed biomass and waste heat recovery (WHR-ORC) systems. Potential opportunities for larger scale geothermal development also exist, through the development of EGS systems. An examination of current electricity and ORC technology prices showed that there is limited potential for the growth of biomass, solar, and WHR-ORC systems in New Zealand through investment from the industrial sector. Binary ORC plant capacity in New Zealand may continue to grow however, as these are developed by electricity generation companies which generally favour more long-term investment criteria.

An EROI analysis of ORC systems shows that the energy cost of obtaining an energy resource varies greatly, whereas the energy cost of plant equipment does not. It therefore follows that the greatest energy wealth can be obtained by ensuring that ORC systems which are developed on the best, low-cost resources are designed towards providing a maximum energy return. Due to the nature of energy analysis, this is true even if purchasing a high-efficiency design reduces the economic performance of that particular installation (to a point), as this minimises the energy burden required by less favourable, lower EROI resources.

The EROI analysis also shows that good energy performance can be achieved by minimising ongoing energy costs, and maximising operational lifetimes and energy outputs. A comparison of this strategy to thermo-economic optimisation techniques has found that while thermo-economic optimisation succeeds in altering ORC designs to create an attractive investment, the same optimisation does not necessarily generate a design that provides the most economic return in terms of energy.

In terms of system design, investigation of high-pressure cycles and intermittent heat sources shows that a wider range of cycle designs are made feasible by the inclusion of a thermal oil loop, and that ORC system designs that use multiple, modular units offer a wide range of advantages while potentially reducing the overall design and installation costs. Economic modelling of ORC systems shows that cost-saving approaches to turbomachinery design may not improve the specific investment cost of ORCs, if the initial cost of the turbine is a relatively small fraction of the overall system cost. The economic modelling performed in this thesis also shows that the inclusion of a regenerator in an ORC cycle can reduce the system parasitic loads, that optimisation of the evaporator and condenser pinch point temperatures can improve the specific investment cost, and that choosing the timing of annual maintenance in New Zealand's seasonal electricity market can improve annual return by 4% for low-temperature ORC systems.

Investigation into material prices, electricity prices, and subsidies – economic factors outside of the control of the ORC designer – shows that changes to these factors can have a large impact on the favourability of ORC systems as an investment. It follows that any future changes to the growth of ORC generation capacity will most likely come from changes in these factors, or from the development of technologies to access new resources, rather than changes to ORC generation technology itself, in which historical developments do not appear to have altered capacity growth rates. An assessment of the effects of economic interventions on ORC systems found that for a given subsidy or cost value, direct capital subsidies most favourably impact ORCs under the traditional assessment criteria investigated, when compared to fossil-fuel based generation.

The results of this thesis show that there are many factors which can influence the direction that further developments of ORC systems might take, and while a system designer might have some control over how an ORC performs, a large portion of the eventual success falls outside of the engineer's control. ORCs sit at an exciting stage in development, as there are new emerging markets and resources for which effective and workable designs can be established. The tools presented in this thesis can be used to help guide the location and timing of future development efforts using ORC technologies, in order to best take advantage of situations where the market and technology align.

## Bibliography – Motivation statement

- Felicitio M, Gazo. Brian Cox, Connie Crookshanks, Barrie Wilkinson. (2011). Low Enthalpy Geothermal Energy: Technological Economic Review. *GNS Science*.
- HERA. (2012). Above Ground Geothermal Allied Technologies. Retrieved 01/04/2013, from [http://www.hera.org.nz/Category?Action=View&Category\\_id=875](http://www.hera.org.nz/Category?Action=View&Category_id=875)
- HERA. (2013). Research Capability. Retrieved 01/04/2013, from [http://www.hera.org.nz/Category?Action=View&Category\\_id=540](http://www.hera.org.nz/Category?Action=View&Category_id=540)
- IEA. (2014). Key World Energy Statistics: International Energy Agency.
- Quoilin, Sylvain, Declaye, Sébastien, Tchanche, Bertrand F., & Lemort, Vincent. (2011). Thermo-economic optimization of waste heat recovery Organic Rankine Cycles. *Applied Thermal Engineering*, 31(14–15), 2885-2893. doi: <http://dx.doi.org/10.1016/j.applthermaleng.2011.05.014>

## Bibliography – Chapter 1

- A. Finch, K. George, B. Tomlin, M. Waters. (2012). NZ Steel Waste Heat Prospecting. In S. Krumdieck (Ed.), *Final Year Project Report*: University of Canterbury.
- Abraham, Theodore J., MacFarlane, Douglas R., & Pringle, Jennifer M. (2013). High Seebeck coefficient redox ionic liquid electrolytes for thermal energy harvesting. *Energy & Environmental Science*. doi: 10.1039/C3EE41608A
- AlphabetEnergy. (2015). E1 Thermoelectric Generator. 2015, from <http://www.alphabetenergy.com/product/e1/>
- Authority(NZ), Electricity. (2013). *Market Data Portal - Demand-Weighted Daily Average Price*. Retrieved from: <http://www.reports.ea.govt.nz/OnlineReports.aspx>
- Bank, World. (2014). *World Development Indicators*.
- Baresi, Marco. (2014). Project H-REII demo: Life EU Programme.
- BCE. (2008). *Waste Heat Recovery: Technology and Opportunities in U.S. Industry*. U.S. Department of Energy.
- Bini, Roberto. (2010). State of the art of ORC technology for biomass plants. *Small scale biomass co-generation: Technology status and market opportunities*. [http://www.ieabcc.nl/workshops/task32\\_Copenhagen/06%20Bini%20-Turboden.pdf](http://www.ieabcc.nl/workshops/task32_Copenhagen/06%20Bini%20-Turboden.pdf)
- Bloomberg. (2013). Geothermal Energy: Unleashing the Earth's Power to Fuel Chile's Future. In A. Reed (Ed.): Natural Resources Defense Council.
- Bronicki L. Y. (2012). Organic Rankine Cycle Power Plant for Waste HEat Recovery. from <http://www.ormat.com/research/papers/organic-rankine-cycle-power-plant-waste-heat-recovery>
- C2ES. (2012). Enhanced Geothermal Systems; Quick Facts. *Center for Climate and Energy Solutions*. Retrieved 11/12/2014, 2014, from <http://www.c2es.org/technology/factsheet/EGS>
- Carlos de Castroa, Margarita Mediavillab, Luis Javier Miguelb, Fernando Frechosoc. (2015). Global solar electric power potential: technocal and ecological limits. *Energy Policy (In press)*.
- Chris J. Bromley, Mike Mongillo, Gerardo Hiriart, Barry Goldstein, Ruggero Bertani, Ernst Huenges, Arni, & Ragnarsson, Jeff Tester, Hirofumi Muraoka, Vladimir Zui. (2010). *Contribution of Geothermal Energy to Climate Change Mitigation: the IPCC Renewable Energy Report*. Paper presented at the World Geothermal Congress, 2010, Bali, Indonesia.
- ClimateScope. (2014). Indonesia. Retrieved 12/01/2015, 2015, from <http://global-climatescope.org/en/country/indonesia/#/details>
- Daniel Walraven, Ben Laenen and William D'haeseleer. (2014). *Economic system optimization of air-cooled organic Rankine cycles powered by low-temperature geothermal heat sources*. Applied Mechanics and Energy Conversion. KU Leuven Energy Institute TME Branch. University of Leuven. Retrieved from <http://www.mech.kuleuven.be/tme/research/>
- DECC. (2014). Industrial electricity prices in the IEA. In IEA (Ed.): GOV.UK National Statistics.

- DiPippo, Ronald. (2011). *Geothermal Power Plants : Principles, Applications, Case Studies and Environmental Impact* (2 ed.). Burlington: Elsevier Science.
- DiPippo, Ronald, & Moya, Paul. (2013). Las Pailas geothermal binary power plant, Rincón de la Vieja, Costa Rica: Performance assessment of plant and alternatives. *Geothermics*, 48(0), 1-15. doi: <http://dx.doi.org/10.1016/j.geothermics.2013.03.006>
- Dr. Richter, Christoph;, & Teske, Sven; Short, Rebecca. (2009). Concentrating Sola Power: Global Outlook 09 (pp. 88): Greenpleace International.
- Electratherm. (2014). ElectraTherm Green Machine Generates Power from Biomass in Italy. 2014, from [http://electratherm.com/case\\_studies/biomass\\_in\\_italy/](http://electratherm.com/case_studies/biomass_in_italy/)
- Enertime, SA. (2012). Cycles Organiques de Rankine: Market and actors. Retrieved 1/10/2014, from <http://www.cycle-organique-rankine.com/technology.php>
- Envergent. (2010). The production of electricity form wood and other solid biomass. In Honeywell (Ed.), *EnvergentTech.com*. Illinois, USA.
- EPIA. (2014). Global market outlook for photovoltaics. In G. M. Tom Rowe, Sinead Orlandi, Manoël Rekingier (Ed.): European Photovoltaic Industry Association.
- Exergy. (2015). References.
- FAO. (2010). Global Forest Resources Assessment 2010: Food and Agriculture Organisation of the United Nations.
- Felicito Gazo, Lisa Lind. (2010). Low Enthalpy Geothermal Energy - Technology Review. *GNS Science*.
- Felicito M, Gazo. Brian Cox, Connie Crookshanks, Barrie Wilkinson. (2011). Low Enthalpy Geothermal Energy: Technological Economic Review. *GNS Science*.
- Fleurbaey, Marc; Zuber, Stephane. (2012-2013). Climate Policies Deserve a Negative Discount Rate. *Chicago International Journal of Law*, 13.
- Franz Trieb, Christoph Schillings, Marlene O'Sullivan, Thomas Pregger, Carsten Hoyer-Klick. (2009). *Global potential of concentrating solar power*. Paper presented at the SolarPaces, Berlin.
- Gabrinski P. (2011). *Optimisation on the performance of an Organic Rankine Cycle used as a waste heat recovery system in a bio-liquid diesel engine power plant*. University of Iceland, University of Akureyri.
- GWEC. (2015). Global Wind Statistics 2014. In L. Fried (Ed.): Global Wind Energy Council.
- Hall, Charles A.S., & Klitgaard, Kent A. (2012). *Energy and the wealth of nations*: Springer.
- Heinimo, J., & Junginger, M. (2009). Production and trading of biomass for energy – An overview of the global status. *Biomass and Bioenergy*, 33(9), 1310-1320. doi: <http://dx.doi.org/10.1016/j.biombioe.2009.05.017>
- Ho, Tony. (2012). Thermal Efficiency from Organic Flash Cycle Market Assessment Report. University of California Berkeley: Cleantech to Market.
- Holdmann, Gwen. (2007). 400kW Geothermal Power Plant at Chena Hot Springs, Alaska. Chena Power Company: Alaska Energy Authority.
- Hrbek, Jitka. (2015). Thermal Gasification Facilities. Vienna University of Technology: IEA.
- Hung, T. C., Shai, T. Y., & Wang, S. K. (1997). A review of organic rankine cycles (ORCs) for the recovery of low-grade waste heat. *Energy*, 22(7), 661-667. doi: [http://dx.doi.org/10.1016/S0360-5442\(96\)00165-X](http://dx.doi.org/10.1016/S0360-5442(96)00165-X)
- IEA. (2002). *Distributed Generation in Liberalised Electricity Markets*. Paris: OECD Publishing.
- IEA. (2010). Renewable energy essentials: geothermal: International Energy Agency.
- IEA. (2014). Key World Energy Statistics: International Energy Agency.
- Ikegami, Yasuyuki; Furugen, Katsuya. (2013). *100 kW CC-OTEC Plant and Deep Oceans Water Applications in Kumejima, Okinawa, Japan*. Paper presented at the Asia Pacific Clean Energy Summit and Expo, Honolulu, Hawaii.
- IPCC. (2012). *Renewable Energy Sources and Climate Change Mitigation*. New York, NY: Cambridge University Press.
- IRENA. (2013). Concentrating Solar Power: Technology Brief.
- Jain, P.K. (1999). *Theory and Problems in Financial Management*: Tata McGraw-Hill.
- Jan Brandin, Martin Tunér, Ingemar Odenbrand. (2011). Small scale gassification: Gas Engine CHP for Biofuels (pp. 138): Swedish Energy Agency.

- Jradi, M., & Riffat, S. (2014). Modelling and testing of a hybrid solar-biomass ORC-based micro-CHP system. *International Journal of Energy Research*, 38(8), 1039-1052. doi: 10.1002/er.3145
- Karl, Bernie. (2009). *Chena Power Reservoir Management at Chena Hot Springs*. Paper presented at the Rural Energy Conference.
- Larson, Eric D., Williams, Robert H., & Leal, M. Regis L. V. (2001). A review of biomass integrated-gasifier/gas turbine combined cycle technology and its application in sugarcane industries, with an analysis for Cuba. *Energy for Sustainable Development*, 5(1), 54-76. doi: [http://dx.doi.org/10.1016/S0973-0826\(09\)60021-1](http://dx.doi.org/10.1016/S0973-0826(09)60021-1)
- Legmann, Hilel. (2015). *The 100-MW Ngatamariki Geothermal Power Station; A Purpose-Built Plant for High Temperature, High Enthalpy Resource*. Paper presented at the World Geothermal Congress 2015, Melbourne, Australia. <https://pangea.stanford.edu/ERE/db/WGC/papers/WGC/2015/06023.pdf>
- Leonardo Pierobon, Tuong-Van Nguyen, Ulrik Larsen, Fredrik Haglind, Brian Elmegaard. (2015). *Multi-objective optimization of organic Rankine cycles for waste heat recovery: Application in an offshore platform*. Technical University of Denmark. Lyngby, Denmark.
- Lindquist EJ, et al. (2012). Global Forest and Land Use Change 1990-2005 *FAO Forestry Paper No. 169*. Rome: FAO.
- Maghiar T., Antal C. (2001). Power generation form low-enthalpy geothermal resources. *Geo-Heat Center Bulletin*, June 2001, 35-37.
- Mario Veroli, Alfonso Calabria. (2014). Solar Assisted Micro ORC Systems for Powerful Plants: A Possible (Italian) Scenarios Comparison. *Energies*, 7(1).
- MBIE. (2015). Energy in New Zealand 2014 (M. a. S. Trends, Trans.): Ministry of Business, Innovation and Employment.
- McKenna, R. C., & Norman, J. B. (2010). Spatial modelling of industrial heat loads and recovery potentials in the UK. *Energy Policy*, 38(10), 5878-5891. doi: <http://dx.doi.org/10.1016/j.enpol.2010.05.042>
- MED(NZ). (2013). New Zealand's Energy Outlook: Electricity Insight (pp. 12): Ministry of Business, Innovation and Employment.
- MED(NZ). (2015). *Electricity cost and price monitoring*. Ministry of Economic Development. NZ Crown. Retrieved from <http://www.med.govt.nz/sectors-industries/energy/energy-modelling/data/prices>
- Nazif, Havidh. (2011). Feasibility of developing binary power plants in the existing geothermal production areas in Indonesia *Geothermal training programme*. Reykjavik, Iceland: United Nations University.
- NIST. (2013). Energy Price Indices and Discount Factors for Life-Cycle Cost Analysis – 2013. In U. D. o. Commerce (Ed.), *NIST Handbook 135 and NBS Special Publication 709*.
- NREL. (2012). Renewable Electricity Futures Study (Entire report). In M. B. Hand, S.; DeMeo, E.; Reilly, J.M.; Mai, T.; Arent, D.; Porro, G.; Meshek, M.; Sandor, D. (Ed.), (4 vols. ed.). Golden, CO: National Renewable Energy Laboratory.
- Nuno Gonçalves, Sérgio Faias, Jorge de Sousa. (2012). *Biomass CHP Technical and Economic Assessment applied to a Sawmill Plant*. Paper presented at the International Conference on Renewable Energies and Power Quality, Santiago de Compostela (Spain).
- Obemberger, Theck, G.;. (2008, April 2008). *Combustion and gasification of solid biomass for heat and power production in europe* Paper presented at the 8th European Conference on Industrial Furnaces and Boilers (keynote), Vilamoura, Portugal.
- ORMAT. (2015). Global Projects. from <http://www.ormat.com/global-project>
- Pelc, Robin, & Fujita, Rod M. (2002). Renewable energy from the ocean. *Marine Policy*, 26(6), 471-479. doi: [http://dx.doi.org/10.1016/S0308-597X\(02\)00045-3](http://dx.doi.org/10.1016/S0308-597X(02)00045-3)
- Peterson, Steven. (2012). *Investment Theory and Risk Management* Retrieved from <http://canterbury.ebib.com.au/patron/FullRecord.aspx?p=821821>
- Pritchard, Geoffrey. (2011). *New Zealand Electricity Prices*. New Zealand wholesale electricity market. Retrieved from: <https://www.stat.auckland.ac.nz/~geoff/elecprices/>
- Qiu, Guoquan, Shao, Yingjuan, Li, Jinxing, Liu, Hao, & Riffat, Saffa B. (2012). Experimental investigation of a biomass-fired ORC-based micro-CHP for domestic applications. *Fuel*, 96(0), 374-382. doi: <http://dx.doi.org/10.1016/j.fuel.2012.01.028>



- Quoilin, S., Dumont, O., Lemort, V., . (2015). Design, modeling and performance optimization of a reversible Heat Pump /Organic Rankine Cycle. *ASME Journal of Engineering for Gas Turbines and Power*, *In Press*.
- Quoilin, Sylvain, Broek, Martijn Van Den, Declaye, Sébastien, Dewallef, Pierre, & Lemort, Vincent. (2013). Techno-economic survey of Organic Rankine Cycle (ORC) systems. *Renewable and Sustainable Energy Reviews*, *22*(0), 168-186. doi: <http://dx.doi.org/10.1016/j.rser.2013.01.028>
- Quoilin, Sylvain, Declaye, Sébastien, Tchanche, Bertrand F., & Lemort, Vincent. (2011). Thermo-economic optimization of waste heat recovery Organic Rankine Cycles. *Applied Thermal Engineering*, *31*(14–15), 2885-2893. doi: <http://dx.doi.org/10.1016/j.applthermaleng.2011.05.014>
- Rauch, Reinhard. (2014). Biomass CHP Oberwart - Production of heat, power and valuable gasses. Austria: Competence Centers for Excelent Technologies.
- Raush, J. , Chambers, T. , Russo, B., Ritter III, K. (2013). Demonstration of Pilot Scale Large Aperture Parabolic Trough Organic Rankine Cycle Solar Thermal Power Plant in Louisiana. *Journal of Power and Energy Engineering*, *1*, 29-39. doi: 10.4236/jpee.2013.17006.
- Reisenhofer, Ingwald Obernberger; Peter Thonhofer; Erwin. (2002). Description and Evaluation of the new 1,000 kWel Organic Rankine Cycle process integrated in the biomass CHP plant in Lienz, Austria. *Euroheat & Power*, *10/2002*, 17.
- Rentizelas, A., Karellas, S., Kakaras, E., & Tatiopoulos, I. (2009). Comparative techno-economic analysis of ORC and gasification for bioenergy applications. *Energy Conversion and Management*, *50*(3), 674-681. doi: <http://dx.doi.org/10.1016/j.enconman.2008.10.008>
- Rowe, D. M. (2005). General Principles and Basic Considerations *Thermoelectrics Handbook* (pp. 1-1-1-14): CRC Press.
- Rutherford, John. (2006). *Heat and Power Applications of Advanced Biomass Gasifiers in New Zealand's Wood Industry*. (Master of Engineering), University of Canterbury, Christchurch, New Zealand.
- Schuster, A., Karellas, S., Kakaras, E., & Spliethoff, H. (2009). Energetic and economic investigation of Organic Rankine Cycle applications. *Applied Thermal Engineering*, *29*(8–9), 1809-1817. doi: <http://dx.doi.org/10.1016/j.applthermaleng.2008.08.016>
- Snyder, G Jeffrey. (2008). Complex Thermoelectric Materials. *Nature Materials*, *7*(2), 10.
- Suresh Baral, Kyung Chun Kim. (2015). Simulation, Validation and Economic Analysis of Solar Powered Organic Rankine Cycle for Electricity Generation. *Journal of Clean Energy Technologies*, *3*(1), 62-67. doi: 10.7763/JOCET.2015.V3.170
- Tchanche, Bertrand F., Lambrinos, Gr, Frangoudakis, A., & Papadakis, G. (2011). Low-grade heat conversion into power using organic Rankine cycles – A review of various applications. *Renewable and Sustainable Energy Reviews*, *15*(8), 3963-3979. doi: <http://dx.doi.org/10.1016/j.rser.2011.07.024>
- Tchanche, Bertrand F., Quoilin, Sylvain,.. (2010). *Economic Feasibility of a small scale Organic Rankine Cycle system in waste heat recovery application*. Paper presented at the Engineering Systems Design and Analysis, Istanbul, Turkey.
- Turboden. (2015). References. from <http://www.turboden.eu/en/references/references.php>
- Ungemach, Pierre; Antics, Miklos. (2010, 11 June 2010). *Assessment of EGS potential*. Paper presented at the Technology Platform: Geothermal Electricity 3rd Meeting, Pisa, Italy.
- Vamshi Avadhanula, Daisy Huang. (2013). Green Machnie Organic Rankine Cycle. In D. C.-S. Lin (Ed.). Alaska Centre for Energy and Power: University of Alaska Fairbanks.
- Vescovo, Riccardo. (2009). ORC recovering industrial heat; power generation from waste energy streams. *Cogeneration and On-Site Power Production*, *5*.
- Walter, Short. (1995). A Manual for the Economic Evaluation of Energy Efficiency and renewable Energy Technologies: National Renewable Energy Laboratory.
- White, Brian. (2009). Waikite Small Geothermal Power Plant Feasibility Study (pp. 20): East Harbour Energy.
- Zarza, Dr Eduardo. (2013). Increasing the efficiency of small scale CSP applications. from <http://social.csptoday.com/technology/increasing-efficiency-small-scale-csp-applications>

## Bibliography – Chapter 2

- Aneke, Mathew, Agnew, Brian, & Underwood, Chris. (2011). Performance analysis of the Chena binary geothermal power plant. *Applied Thermal Engineering*, 31(10), 1825-1832. doi: <http://dx.doi.org/10.1016/j.applthermaleng.2011.02.028>
- APS. (2013). Energy units. Retrieved 02/08/2013, 2013, from <http://www.aps.org/policy/reports/popa-reports/energy/units.cfm>
- Atlason, R. S., & Unnthorsson, R. (2013). Hot water production improves the energy return on investment of geothermal power plants. *Energy*, 51(0), 273-280. doi: <http://dx.doi.org/10.1016/j.energy.2013.01.003>
- Beal, ColinM, Hebner, RobertE, Webber, MichaelE, Ruoff, RodneyS, & Seibert, A. Frank. (2012). The Energy Return on Investment for Algal Biocrude: Results for a Research Production Facility. *BioEnergy Research*, 5(2), 341-362. doi: 10.1007/s12155-011-9128-4
- Bini, Roberto. (2010). State of the art of ORC technology for biomass plants. *Small scale biomass co-generation: Technology status and market opportunities*. [http://www.ieabcc.nl/workshops/task32\\_Copenhagen/06%20Bini%20-Turboden.pdf](http://www.ieabcc.nl/workshops/task32_Copenhagen/06%20Bini%20-Turboden.pdf)
- Cleveland, Cutler J. (2005). Net energy from the extraction of oil and gas in the United States. *Energy*, 30(5), 769-782. doi: <http://dx.doi.org/10.1016/j.energy.2004.05.023>
- Cleveland, Cutler J., Costanza, Robert, Hall, Charles A. S., & Kaufmann, Robert. (1984). Energy and the U.S. Economy: A Biophysical Perspective. *Science*, 225(4665), 890-897. doi: 10.2307/1693932
- Dale, Michael. (2010). *Global Energy Modelling: A Biophysical Approach*. (Ph.D. Thesis), University of Canterbury, University of Canterbury Library.
- Dale, Michael, Krumdieck, Susan, & Bodger, Pat. (2011). Net energy yield from production of conventional oil. *Energy Policy*, 39(11), 7095-7102. doi: <http://dx.doi.org/10.1016/j.enpol.2011.08.021>
- Enertime, SA. (2012). Cycles Organiques de Rankine: Market and actors. Retrieved 1/10/2014, from <http://www.cycle-organique-rankine.com/technology.php>
- Fiaschi, Daniele, Lifshitz, Adi, Manfrida, Giampaolo, & Tempesti, Duccio. (2014). An innovative ORC power plant layout for heat and power generation from medium- to low-temperature geothermal resources. *Energy Conversion and Management*, 88(0), 883-893. doi: <http://dx.doi.org/10.1016/j.enconman.2014.08.058>
- Gagnon, Nathan, Hall, Charles, & Brinker, Lysle. (2009). A Preliminary Investigation of Energy Return on Energy Investment for Global Oil and Gas Production. *Energies*, 2(3), 490-503.
- GREET. (2010). *The Greenhouse Gases, Regulated Emissions, and Energy use in Transportation Model*. Retrieved from: <http://greet.es.anl.gov/>
- Hall, Charles A.S., & Klitgaard, Kent A. (2012). *Energy and the wealth of nations*: Springer.
- Hall, Charles, Balogh, Stephen, & Murphy, David. (2009). What is the Minimum EROI that a Sustainable Society Must Have? *Energies*, 2(1), 25-47.
- Holdmann, Gwen. (2007a). 400kW Geothermal Power Plant at Chena Hot Springs, Alaska. Chena Power Company: Alaska Energy Authority.
- Holdmann, Gwen. (2007b). The Chena Hot Springs 400kW Geothermal Power Plant: Experience Gained During the First Year of Operation (pp. 9): Chena Power.
- IEA. (2013). *World Energy Outlook 2013*: IEA.
- IEA. (2014a). Executive Summary *Renewable Energy Medium Term Market Report*. OECD/IEA: International Energy Agency.
- IEA. (2014b). Key World Energy Statistics: International Energy Agency.
- Jradi, M., & Riffat, S. (2014). Modelling and testing of a hybrid solar-biomass ORC-based micro-CHP system. *International Journal of Energy Research*, 38(8), 1039-1052. doi: 10.1002/er.3145
- Karl, Bernie. (2009). *Chena Power Reservoir Management at Chena Hot Springs*. Paper presented at the Rural Energy Conference.
- King, Carey. (2013, January 8, 2013). *Energy Principles for Understanding if Energy Production is an Economic Constraint*. Paper presented at the Webber Energy Group Symposium, The University of Texas, Austin.

- King, Carey W., & Hall, Charles A.S. (2011). Relating Financial and Energy Return on Investment. *Sustainability*, 3(10), 1810-1832.
- Lambert, J.; Hall, C.; Balogh, S.; Poisson, A.; Gupta, A. (2013). EROI of Global Energy Resources. SUNY - Environmental Science & Forestry, Next Generation Energy Initiative, Inc.: United Kingdom Department for International Development.
- Lambert, Jessica G., Hall, Charles A. S., Balogh, Stephen, Gupta, Ajay, & Arnold, Michelle. (2014). Energy, EROI and quality of life. *Energy Policy*, 64(0), 153-167. doi: <http://dx.doi.org/10.1016/j.enpol.2013.07.001>
- MBIE. (2015). Energy in New Zealand 2014 (M. a. S. Trends, Trans.): Ministry of Business, Innovation and Employment.
- MED(NZ). (2011). NZ Energy Data File.
- Mulder, Kenneth, & Hagens, Nathan John. (2008). Energy Return on Investment: Toward a Consistent Framework. *Ambio*, 37(2), 74-79. doi: 10.2307/25547857
- Murphy, David J., & Hall, Charles A. S. (2010). Year in review—EROI or energy return on (energy) invested. *Annals of the New York Academy of Sciences*, 1185(1), 102-118. doi: 10.1111/j.1749-6632.2009.05282.x
- Murphy, David J., & Hall, Charles A. S. (2011). Energy return on investment, peak oil, and the end of economic growth. *Annals of the New York Academy of Sciences*, 1219(1), 52-72. doi: 10.1111/j.1749-6632.2010.05940.x
- Murphy, David J., Hall, Charles A.S., Dale, Michael, & Cleveland, Cutler. (2011). Order from Chaos: A Preliminary Protocol for Determining the EROI of Fuels. *Sustainability*, 3(10), 1888-1907.
- NREL. (2012). Renewable Electricity Futures Study (Entire report). In M. B. Hand, S.; DeMeo, E.; Reilly, J.M.; Mai, T.; Arent, D.; Porro, G.; Meshek, M.; Sandor, D. (Ed.), (4 vols. ed.). Golden, CO: National Renewable Energy Laboratory.
- OMS. (2008). Liquid fuel use in NZ (pp. 31): Ministry of Economic Development.
- Quoilin, Sylvain, Broek, Martijn Van Den, Declaye, Sébastien, Dewallef, Pierre, & Lemort, Vincent. (2013). Techno-economic survey of Organic Rankine Cycle (ORC) systems. *Renewable and Sustainable Energy Reviews*, 22(0), 168-186. doi: <http://dx.doi.org/10.1016/j.rser.2013.01.028>
- Reisenhofer, Ingwald Obernberger; Peter Thonhofer; Erwin. (2002). Description and Evaluation of the new 1,000 kWel Organic Rankine Cycle process integrated in the biomass CHP plant in Lienz, Austria. *Euroheat & Power*, 10/2002, 17.
- Rutherford, John. (2006). *Heat and Power Applications of Advanced Biomass Gasifiers in New Zealand's Wood Industry*. (Master of Engineering), University of Canterbury, Christchurch, New Zealand.
- Schlömer S., T. Bruckner, L. Fulton, E. Hertwich, A. McKinnon, D. Perczyk, J. Roy, R. Schaeffer, R. Sims, P. Smith, and R. Wisser. (2014). Annex III: Technology-specific cost and performance parameters *Climate Change 2014: Mitigation of Climate Change. Contribution of Working Group III to the Fifth Assessment Report of the Intergovernmental Panel on Climate Change*. Cambridge, UK and New York, USA: Cambridge University.
- Schuster, A., Karellas, S., Kakaras, E., & Spliethoff, H. (2009). Energetic and economic investigation of Organic Rankine Cycle applications. *Applied Thermal Engineering*, 29(8-9), 1809-1817. doi: <http://dx.doi.org/10.1016/j.applthermaleng.2008.08.016>
- SKM, NZGA. (2009). Assessment of Current Costs of Geothermal Power Generation in New Zealand (2007 Basis) (pp. 78): New Zealand Geothermal Association and SKM.
- Spinelli, R.; Cavallo E., Eliasson L.; Facello A.;. (2013). Comparing the efficiency of drum and disc chippers. *Silva Fennica*, 47(2), 11.
- Statistics, Bureau of Labor. (2014). Producer Price Index - Industry Data (US). In E. Releases (Ed.): U.S. Department Of Labor.
- Statistics, U.S. (2011). Manufacturing average hourly compensation costs in U.S. dollars, by components of compensation, 2011. *U.S. Bureau of Labor Statistics, International Labor Comparisons*. from <http://www.bls.gov/spotlight/2013/ilc/>
- Tester, Jeff (Producer). (2011). Oil and Gas Well Drilling. [Lecture slides] Retrieved from [http://cce.cornell.edu/EnergyClimateChange/NaturalGasDev/Documents/CHEME%206666%20Lecture%20Series-2011/CHEME%206666\\_07\\_Drilling%20Lecture.pdf](http://cce.cornell.edu/EnergyClimateChange/NaturalGasDev/Documents/CHEME%206666%20Lecture%20Series-2011/CHEME%206666_07_Drilling%20Lecture.pdf)

- US 2002 Industry Benchmark model. (2008). *Economic Input-Output Life Cycle Assessment (EIO-LCA)*. Retrieved [Accessed August 2014, from <http://www.eiolca.net>]
- UTC Pratt & Whitney, Turboden. (2009). Model 280 PureCycle® Power System Brochure. Pratt & Whitney.
- Vescovo, Riccardo. (2009). ORC recovering industrial heat; power generation from waste energy streams. *Cogeneration and On-Site Power Production*, 5.
- Videl, Olivier (2010). Seminar presentation at *Science for Energy Scenarios*, Ecole de physique des Houches, Houches, France, 2-7 February 2014.
- Weißbach, D., Ruprecht, G., Huke, A., Czernski, K., Gottlieb, S., & Hussein, A. (2013). Energy intensities, EROIs (energy returned on invested), and energy payback times of electricity generating power plants. *Energy*, 52(0), 210-221. doi: <http://dx.doi.org/10.1016/j.energy.2013.01.029>
- White, Brian. (2009). Waikite Small Geothermal Power Plant Feasibility Study (pp. 20): East Harbour Energy.

Figure 2.1 original caption; 'Oil production costs from various sources as a function of the EROI of those sources. The dotted lines represent the real oil price averaged over both recessions and expansions during the period from 1970 through 2008. EROI data for oil sands come from Murphy and Hall, the EROI values for both Saudi Crude and ultradeep water were interpolated from other EROI data in Murphy and Hall, data on the EROI of average global oil production are from Gagnon et al., and the data on the cost of production come from CERA.'

- Murphy, D.J. & C.A.S. Hall. 2010. Year in review—EROI or energy return on (energy) invested. *Ann. N.Y. Acad. Sci.* 1185: 102–118.
- BEA. 2009. Bureau of economic analysis. [http://www.bea.gov/industry/gpotables/gpo\\_action.cfm?anon=865](http://www.bea.gov/industry/gpotables/gpo_action.cfm?anon=865) (accessed July 12, 2009).
- McKinsey, . 2009. *Averting the Next Energy Crisis: The Demand Challenge*. McKinsey Global Institution. New York

Figure 2.2 Original caption: 'EROI for conventional and alternative energy systems. (The dashed horizontal line represents the energy break-even point, EROI=1.0).'

## Bibliography – Chapter 3

- A. Finch, K. George, B. Tomlin, M. Waters. (2012). NZ Steel Waste Heat Prospecting. In S. Krumdieck (Ed.), *Final Year Project Report*: University of Canterbury.
- Bini, Roberto. (2010). State of the art of ORC technology for biomass plants. *Small scale biomass co-generation: Technology status and market opportunities*. [http://www.ieabcc.nl/workshops/task32\\_Copenhagen/06%20Bini%20-Turboden.pdf](http://www.ieabcc.nl/workshops/task32_Copenhagen/06%20Bini%20-Turboden.pdf)
- Bouman R.W., Jesen S.B., Wake M.L.,. (2005). Process capital cost estimation for New Zealand 2004. In E. W.B. (Ed.): Society of chemical engineers New Zealand.
- Buchanan T., Posten W., Berryman S.,. (2010). *Repowering Steamboat 2 and 3 Plants with New Axial Flow Turbines*. Paper presented at the World Geothermal Congress 2010, Bali, Indonesia. <http://www.geothermal-energy.org/pdf/IGAstandard/WGC/2010/2655.pdf>
- Calise, Francesco, Capuozzo, Claudio, Carotenuto, Alberto, & Vanoli, Laura. (2014). Thermo-economic analysis and off-design performance of an organic Rankine cycle powered by medium-temperature heat sources. *Solar Energy*. doi: <http://dx.doi.org/10.1016/j.solener.2013.09.031>
- Careers, NZ. (May 2014). Boiler Attendant. *Jobs database*. from <http://www.careers.govt.nz/jobs/maintenance-repair/boiler-attendant/>
- Cayer, Emmanuel, Galanis, Nicolas, Desilets, Martin, Nesreddine, Hakim, & Roy, Philippe. (2009). Analysis of a carbon dioxide transcritical power cycle using a low temperature source. *Applied Energy*, 86(7–8), 1055-1063. doi: <http://dx.doi.org/10.1016/j.apenergy.2008.09.018>
- Chen, Y., Lundqvist, P., Johansson, A., & Platell, P. (2006). A comparative study of the carbon dioxide transcritical power cycle compared with an organic rankine cycle with R123 as working fluid in waste heat recovery. *Applied Thermal Engineering*, 26(17–18), 2142-2147. doi: <http://dx.doi.org/10.1016/j.applthermaleng.2006.04.009>
- Chen, Y., Lundqvist, P., Johansson, A., Platell, P. (2006). A comparative study of the carbon dioxide transcritical power cycle compared with an organic rankine cycle with R123 as working fluid in waste heat recovery. *Applied Thermal Engineering*, 26(17–18), 2142-2147. doi: <http://dx.doi.org/10.1016/j.applthermaleng.2006.04.009>
- Chetwin, J.M. (2005). *The design, safe operation, maintenance and servicing of Boilers*. Wellington: Occupational Safety and Health Service.
- Cooling Tower Systems, Inc. (2013). Cooling tower price list. Retrieved 02/08/2013, from [http://www.coolingtowersystems.com/cooling\\_twr\\_price.php](http://www.coolingtowersystems.com/cooling_twr_price.php)
- Couper, James R., Penney, W. Roy, Fair, James R., & Walas, Stanley M. (2010). Chapter 21 - COSTS OF INDIVIDUAL EQUIPMENT. In J. R. C. R. P. R. F. M. Walas (Ed.), *Chemical Process Equipment (Second Edition)* (pp. 717-726). Boston: Gulf Professional Publishing.
- Dai, Yiping, Wang, Jiangfeng, & Gao, Lin. (2009). Parametric optimization and comparative study of organic Rankine cycle (ORC) for low grade waste heat recovery. *Energy Conversion and Management*, 50(3), 576-582. doi: <http://dx.doi.org/10.1016/j.enconman.2008.10.018>
- GEA. (2011). GEA PHE Systems. In G. H. Exchangers (Ed.). Sarstedt Germany.
- GEA. (2012). GEA GBH - Blazed plate heat exchangers. In GEA (Ed.).
- Gerold Thek, Ingwald Obernberger. (2004). Techno-economic evaluation of selected decentralised CHP applications based on biomass combustion in IEA partner countries. Graz, Austria: Bioenergiesysteme GmbH.
- Gerrard, A.M. (2000). *Guide to capital cost estimating* (4th ed.): Institution of Chemical Engineers (Great Britain) Association of Cost Engineers.
- Ho, Tony, Mao, Samuel S., & Greif, Ralph. (2012). Comparison of the Organic Flash Cycle (OFC) to other advanced vapor cycles for intermediate and high temperature waste heat reclamation and solar thermal energy. *Energy (Oxford)*, 42(1), 213-223. doi: <http://dx.doi.org/10.1016/j.energy.2012.03.067>
- Holdmann, Gwen. (2007). 400kW Geothermal Power Plant at Chena Hot Springs, Alaska. Chena Power Company: Alaska Energy Authority.
- Hung, T. C., Shai, T. Y., & Wang, S. K. (1997). A review of organic rankine cycles (ORCs) for the recovery of low-grade waste heat. *Energy*, 22(7), 661-667. doi: [http://dx.doi.org/10.1016/S0360-5442\(96\)00165-X](http://dx.doi.org/10.1016/S0360-5442(96)00165-X)



- Invernizzi, Mario. (2013). *Closed Power Cycles: Thermodynamic fundamentals and applications* (Vol. 11). London: Springer.
- ISO. (2000). Thermal turbines for industrial applications (steam turbines, gas expansion turbines) - General requirements 14661:2000(E) (Vol. 6, pp. 63). ISO copyright office.
- Japikse, David, & Baines, Nicholas. (1997). *Introduction to Turbomachinery*: Concepts NREC.
- Kaori. (2011). Gasketed-Type Plate Heat Exchangers.
- Laval, Alfa. (2014). M30 Plate Heat Exchanger. In A. Laval (Ed.).
- Lecompte, S., Huisseune, H., van den Broek, M., De Schampheleire, S., & De Paepe, M. (2013). Part load based thermo-economic optimization of the Organic Rankine Cycle (ORC) applied to a combined heat and power (CHP) system. *Applied Energy*, 111(0), 871-881. doi: <http://dx.doi.org/10.1016/j.apenergy.2013.06.043>
- Lemort, Vincent, Quoilin, Sylvain, Cuevas, Cristian, & Lebrun, Jean. (2009). Testing and modeling a scroll expander integrated into an Organic Rankine Cycle. *Applied Thermal Engineering*, 29(14-15), 3094-3102. doi: <http://dx.doi.org/10.1016/j.applthermaleng.2009.04.013>
- Li, Maoqing, Wang, Jiangfeng, Li, Saili, Wang, Xurong, He, Weifeng, & Dai, Yiping. (2014). Thermo-economic analysis and comparison of a CO<sub>2</sub> transcritical power cycle and an organic Rankine cycle. *Geothermics*, 50(0), 101-111. doi: <http://dx.doi.org/10.1016/j.geothermics.2013.09.005>
- Man-Hoe Kim, Jostein Pettersen, Clark W. Bullard,. (2004). Fundamental process and system design issues in CO<sub>2</sub> vapour compression systems. *Progress in Energy and Combustion Science*, 30, 119-174.
- Mario Veroli, Alfonso Calabria. (2014). Solar Assisted Micro ORC Systems for Powerful Plants: A Possible (Italian) Scenarios Comparison. *Energies*, 7(1).
- Mohr, C, Mines, G, Bloomfield, K. (2002). Continual removal of non-condensable gases for binary power plant condensers. *Transactions - Geothermal Resources Council*, 25, 781 - 783.
- Nazif, Havidh. (2011). Feasibility of developing binary power plants in the existing geothermal production areas in Indonesia *Geothermal training programme*. Reykjavik, Iceland: United Nations University.
- Nellis, Gregory, & Klein, Sanford. (2008). *Heat Transfer* Retrieved from <http://canterbury.ebib.com.au/patron/FullRecord.aspx?p=424535>
- Perry, Robert H., Green, Don W. (2008). *Perry's chemical engineers' handbook* (Vol. 7): McGraw-Hill New York.
- Quoilin, Sylvain. (2007). *Experimental Study and Modeling of a Low Temperature Rankine Cycle for Small Scale Cogeneration*. (Electro-Mechanical Engineer), University of Liege.
- Quoilin, Sylvain. (2008). An introduction to thermodynamics applied to Organic Rankine Cycles. In M. I. o. Technology (Ed.): STG International.
- Quoilin, Sylvain, Broek, Martijn Van Den, Declaye, Sébastien, Dewallef, Pierre, & Lemort, Vincent. (2013). Techno-economic survey of Organic Rankine Cycle (ORC) systems. *Renewable and Sustainable Energy Reviews*, 22(0), 168-186. doi: <http://dx.doi.org/10.1016/j.rser.2013.01.028>
- Quoilin, Sylvain, Declaye, Sébastien, Tchanche, Bertrand F., & Lemort, Vincent. (2011). Thermo-economic optimization of waste heat recovery Organic Rankine Cycles. *Applied Thermal Engineering*, 31(14-15), 2885-2893. doi: <http://dx.doi.org/10.1016/j.applthermaleng.2011.05.014>
- Reisenhofer, Ingwald Obernberger; Peter Thonhofer; Erwin. (2002). Description and Evaluation of the new 1,000 kWel Organic Rankine Cycle process integrated in the biomass CHP plant in Lienz, Austria. *Euroheat & Power*, 10/2002, 17.
- Reshef Ran., Fever Tomas. (2012). Ormat plants: from remote monitoring to remote operation. *GRC Transactions*, 36.
- Rojas, Francisco. (2014). Supercritical CO<sub>2</sub> power cycles. 2015, from <http://thinkgeoenergy.com/archives/20576>
- Roy, J. P., Mishra, M. K., & Misra, Ashok. (2011). Performance analysis of an Organic Rankine Cycle with superheating under different heat source temperature conditions. *Applied Energy*, 88(9), 2995-3004. doi: <http://dx.doi.org/10.1016/j.apenergy.2011.02.042>
- Schröder, Elisabeth, Neumaier, Klaus, Nagel, Fabian, & Vetter, Christian. (2014). Study on Heat Transfer in Heat Exchangers for a New Supercritical Organic Rankine Cycle. *Heat Transfer Engineering*, 35(18), 1505-1519. doi: 10.1080/01457632.2014.897558

- SKM, NZGA. (2009). Assessment of Current Costs of Geothermal Power Generation in New Zealand (2007 Basis) (pp. 78): New Zealand Geothermal Association and SKM.
- Tchanche, Bertrand F., Lambrinos, Gr, Frangoudakis, A., & Papadakis, G. (2011). Low-grade heat conversion into power using organic Rankine cycles – A review of various applications. *Renewable and Sustainable Energy Reviews*, 15(8), 3963-3979. doi: <http://dx.doi.org/10.1016/j.rser.2011.07.024>
- Tranter. (2010). Gasketed and Welded heat exchangers for every need. In Tranter (Ed.), *Heat Exchangers*.
- Turboden. (2015). References. from <http://www.turboden.eu/en/references/references.php>
- UTC Pratt & Whitney, Turboden. (2009). Model 280 PureCycle® Power System Brochure. Pratt & Whitney.
- Vescovo, Riccardo. (2009). ORC recovering industrial heat; power generation from waste energy streams. *Cogeneration and On-Site Power Production*, 5.
- Vidhi, Rachana, Kuravi, Sarada, Yogi Goswami, D., Stefanakos, Elias, & Sabau, Adrian S. (2013). Organic Fluids in a Supercritical Rankine Cycle for Low Temperature Power Generation. *Journal of Energy Resources Technology*, 135(4), 042002-042002. doi: 10.1115/1.4023513
- White, Brian. (2009). Waikite Small Geothermal Power Plant Feasibility Study (pp. 20): East Harbour Energy.

## Bibliography – Chapter 4

- Authority(NZ), Electricity. (2013). *Market Data Portal - Demand-Weighted Daily Average Price*. Retrieved from: <http://www.reports.ea.govt.nz/OnlineReports.aspx>
- Bank, World. (2014). State and trends of carbon pricing: 2014. Washington, DC: World Bank.
- Baresi, Marco. (2014). Project H-REII demo: Life EU Programme.
- Bay of Plenty Regional Council, Waikato University. (2014). *Rotorua Lakes Monitoring Project; Lake Tarawera Buoy*. Retrieved from: <http://monitoring.boprc.govt.nz/MonitoredSites/cgi-bin/hydwebserver.cgi/sites/details?site=298&>
- Calin M . Popescu , Kan Phaobunjong , and Nuntapong Ovararin. (2003). *Concrete Estimating Building Costs*: CRC Press.
- DiPippo, Ronald. (2007). Ideal thermal efficiency for geothermal binary plants. *Geothermics*, 36(3), 276-285. doi: <http://dx.doi.org/10.1016/j.geothermics.2007.03.002>
- EIA. (2012). Average Power Plant Operating Expenses for Major U.S. Investor-Owned Electric Utilities. *Electric power annual*. from [http://www.eia.gov/electricity/annual/html/epa\\_08\\_04.html](http://www.eia.gov/electricity/annual/html/epa_08_04.html)
- Environment, Ministry for the. (2012a). Energy's obligations: Reporting emissions and surrendering NZUs. *Climate change information New Zealand*. 2015, from <http://www.climatechange.govt.nz/emissions-trading-scheme/participating/energy/obligations/>
- Environment, Ministry for the. (2012b). Forestry in the Emissions Trading Scheme. *Climate change information New Zealand*. from <https://www.climatechange.govt.nz/emissions-trading-scheme/participating/forestry/>
- Environment, Ministry for the. (2013). *A guide to synthetic greenhouse gas activities in the New Zealand Emissions Trading Scheme: 2013*. (ME 1108). Wellington: Ministry for the Environment.
- Europa. (2015). The EU Emissions Trading Scheme. from [http://ec.europa.eu/clima/policies/ets/index\\_en.htm](http://ec.europa.eu/clima/policies/ets/index_en.htm)
- Fleurbaey, Marc; Zuber, Stephane. (2012-2013). Climate Policies Deserve a Negative Discount Rate. *Chicago International Journal of Law*, 13.
- Graaf, Peter de. (2014). Ngawha explosion scare, *The Northern Advocate*. Retrieved from [http://www.nzherald.co.nz/northern-advocate/news/article.cfm?c\\_id=1503450&objectid=11211490](http://www.nzherald.co.nz/northern-advocate/news/article.cfm?c_id=1503450&objectid=11211490)
- Holdmann, Gwen. (2007). 400kW Geothermal Power Plant at Chena Hot Springs, Alaska. Chena Power Company: Alaska Energy Authority.
- IMF. (2015). IMF Primary Commodity Prices. from <http://www.imf.org/external/np/res/commod/index.aspx>
- Iwan Meier, Vefa Tarhan (2007). *Corporate Investment Decision Practices and the Hurdle Rate Premium Puzzle* Loyola University of Chicago. Social Science Research Network. Retrieved from <http://ssrn.com/abstract=960161>
- J.L. Sullivan, C.E. Clark, J. Han, and M. Wang. (2010). Life-Cycle Analysis Results of Geothermal Systems in Comparison to Other Power Systems (E. S. Division, Trans.): UChicago, Argonne.
- Kreith, Frank., Krumdieck, Susan. (2013). *Principles of sustainable energy systems* (Second ed.): Boca Raton : CRC Press.
- LME. (2015). Prices - February 2015. from <http://www.lme.com/metals/reports/averages/>
- MED(NZ). (2013). New Zealand's Energy Outlook: Electricity Insight (pp. 12): Ministry of Business, Innovation and Employment.
- MED(NZ). (2015). *Electricity cost and price monitoring*. Ministry of Economic Development. NZ Crown. Retrieved from <http://www.med.govt.nz/sectors-industries/energy/energy-modelling/data/prices>
- MEEA. (2009). Biomass Briefing. In M. S. D. Booth, Alexandria (Ed.), (pp. 11): Massachusetts Environmental Energy Alliance.
- Mendelsohn M., Feldman D. (2013). Financing U.S. Renewable Energy Projects Through Public Capital Vehicles: Qualitative and Quantitative Benefits. Golden, Colorado: NREL.



- Michael Southon, Susan Krumdieck. (2014). *Commissioning, initial testing and results from an experimental one kilowatt organic rankine cycle*. Paper presented at the New Zealand Geothermal Workshop, Auckland, New Zealand.
- Mills C., Bush M., Ghazali M., Marks N., (2013). Gas Turbine Bottoming Cycle (D. o. M. Engineering, Trans.): University of Canterbury.
- NIWA. (2015). *The National Climate Database*. Retrieved from: <http://cliflo.niwa.co.nz/>
- NZGA. (2012). Emissions. 2015, from <http://www.nzgeothermal.org.nz/emissions.html>
- Oxera. (2011). Discount rates for low-carbon and renewable generation technologies. Committee on Climate Change: Oxera Consulting Ltd.
- Peterson, Stephen R. (1994). *Energy Prices and Discount Factors for Life-Cycle Cost Analysis 1995*. National Institute of Standards and Technology.
- Poterba J. M., Summers L. (1995). A CEO survey of U.S. companies' time horizons and hurdle rates. *Sloan Management Review*, 37(1).
- Pritchard, Geoffrey. (2011). *New Zealand Electricity Prices*. New Zealand wholesale electricity market. Retrieved from: <https://www.stat.auckland.ac.nz/~geoff/elecprices/>
- Proost, Stef. (2013). *Climate Change Policy in a Non-Cooperative World*. Paper presented at the Euroforum, Leuven, Belgium.
- Reisenhofer, Ingwald Obernberger; Peter Thonhofer; Erwin. (2002). Description and Evaluation of the new 1,000 kWel Organic Rankine Cycle process integrated in the biomass CHP plant in Lienz, Austria. *Euroheat & Power*, 10/2002, 17.
- Rushing A.S., Kneifel J.D., Lavappa P., (2014). Energy Price Indices and Discount Factors for Life-Cycle Cost Analysis: U.S. Department of Commerce.
- Saidur, R., Abdelaziz, E. A., Demirbas, A., Hossain, M. S., & Mekhilef, S. (2011). A review on biomass as a fuel for boilers. *Renewable and Sustainable Energy Reviews*, 15(5), 2262-2289. doi: <http://dx.doi.org/10.1016/j.rser.2011.02.015>
- Schlömer S., T. Bruckner, L. Fulton, E. Hertwich, A. McKinnon, D. Perczyk, J. Roy, R. Schaeffer, R. Sims, P. Smith, and R. Wisser. (2014). Annex III: Technology-specific cost and performance parameters *Climate Change 2014: Mitigation of Climate Change. Contribution of Working Group III to the Fifth Assessment Report of the Intergovernmental Panel on Climate Change*. Cambridge, UK and New York, USA: Cambridge University.
- Statistics, Bureau of Labor. (2014). Producer Price Index - Industry Data (US). In E. Releases (Ed.): U.S. Department Of Labor.
- SteelBenchmarker. (2015). Price History - Tables and Charts. Report #214., from <http://steelbenchmarker.com/>
- Stern, Nicholas. (2006). The Stern Review on the Economic Effects of Climate Change. *Population and Development Review*, 32(4), 793-798. doi: 10.1111/j.1728-4457.2006.00153.x
- Tipping J. P., Read E. G., McNickle D. C., (2004). *The Incorporation of Hydro Storage into a Spot Price Model for the New Zealand Electricity Market*. Department of Management. University of Canterbury.
- Toolbox, Engineering. (2010). Cooling tower efficiency. 2015, from [http://www.engineeringtoolbox.com/cooling-tower-efficiency-d\\_699.html](http://www.engineeringtoolbox.com/cooling-tower-efficiency-d_699.html)
- UTC Pratt & Whitney, Turboden. (2009). Model 280 PureCycle® Power System Brochure. Pratt & Whitney.
- Weisser, Daniel. (2007). A guide to life-cycle greenhouse gas (GHG) emissions from electric supply technologies. *Energy*, 32(9), 1543-1559. doi: <http://dx.doi.org/10.1016/j.energy.2007.01.008>
- White, Brian. (2009). Waikite Small Geothermal Power Plant Feasibility Study (pp. 20): East Harbour Energy.

## Appendix A1

Table A1.1: Current and potential forest usage for biomass. Assumptions and estimates are presented in italics.

	<b>Calculation factor</b>	<b>Value</b>	<b>Unit</b>	<b>Formula / source</b>
A	World land area covered by forests	31.0%		FAO 2012
B	<i>Of which is productive forest plantation</i>	<i>8.1%</i>		<i>FAO 2010</i>
C	Permanent meadows and pastures (Livestock)	22.7%		FAO 2012
D	Area covered by permanent and rotating crops	10.3%		FAO 2012
E'	Annual biomass production	11.9	Gt	Lindquist 2012
E	<i>Sustainable biomass production (86 % estimated)</i>	<i>10.1</i>	<i>Gt</i>	<i>Section 1.4.3.</i>
	Annual biomass energy production	46.6	EJ/yr	IEA 2014
F	<i>Sustainable biomass energy production</i>	<i>40.1</i>	<i>EJ/yr</i>	<i>Section 1.4.3.</i>
G	<i>Average biomass HHV</i>	<i>15</i>	<i>GJ/t</i>	<i>Assumed</i>
H	Annual biomass combustion	2.7	Gt	F/G
I	% of biomass used for combustion	23%		H/E'
J	Fuel energy to electricity conversion efficiency	20%		(Bini, 2010)
K	<b>Electricity if all combustion was in ORC systems</b>	8.0	EJ/yr	F*J
	<b><i>If all permanent meadows and pastures were converted into productive forest</i></b>			
L	<i>Annual biomass production</i>	<i>94.0</i>	<i>Gt</i>	<i>E*C/(B*A)+H</i>
M	<i>Annual biomass energy production if all combusted</i>	<i>1410</i>	<i>EJ/yr</i>	<i>G*L</i>
N	<b><i>Annual electricity production if combusted in ORC</i></b>	<i>280</i>	<i>EJ/yr</i>	<i>J*M</i>

Table A1.2 part 1: Technology types and surrounding economic environment of ORC systems in the analyses surveyed.

Study Author	System Resource	System Design	Net Power (MWe)	Country	Resource Temp. °C	Electricity price (\$/kW) (USD 2014)	Policy support	Selling /utilising waste heat?	Study Currency	Peer-reviewed
<b>(Reisenhofer, 2002)</b>	Biomass	Regenerative, silicon oil	1.000	Austria (Lienz)	300	\$0.277	Yes	Yes	Euro	No
<b>(Nuno Gonçalves, 2012)</b>	Biomass	Regenerative ORC	0.385	Spain	Unknown	\$0.196	Yes	Yes	Euro	Yes
<b>(Holdmann, 2007)</b>	Geothermal	Regenerative	0.420	USA (Alaska)	73	\$0.220	No	No	USD	Real results
<b>(Nazif, 2011)</b>	Geothermal	Regenerative, bottoming flash cycle	2.000	Indonesia	250	\$0.124	Yes	Yes	USD	Yes
<b>(Nazif, 2011)</b>	Geothermal	Regenerative, bottoming cycle (direct HX with brine)	2.000	Indonesia	250	\$0.124	Yes	Yes	USD	Yes
<b>(Nazif, 2011)</b>	Geothermal	Regenerative, bottoming cycle with flash condensate addition to avoid silica	2.000	Indonesia	250	\$0.124	Yes	Yes	USD	Yes
<b>(Nazif, 2011)</b>	Geothermal	Regenerative, bottoming cycle with flash condensate addition to avoid silica	2.000	Indonesia	250	\$0.124	Yes	Yes	USD	Yes
<b>(White, 2009)</b>	Geothermal	Regenerative	0.219	New Zealand	99	\$0.065	No	Yes	USD	No
<b>(Ho, 2012)</b>	Geothermal	Modified OFC	1.000	USA	250 approx	\$0.071	No	No	USD	No
<b>(Ho, 2012)</b>	Geothermal	Regenerative ORC	1.000	USA	250 approx	\$0.071	No	No	USD	No
<b>(Daniel Walraven, 2014)</b>	Geothermal	Regenerative	5.300	Belgium	126	\$0.066	No	No	Euro	Yes
<b>(Daniel Walraven, 2014)</b>	Geothermal	Basic	5.600	Belgium	125	\$0.066	No	No	Euro	Yes
<b>(Mario Veroli, 2014)</b>	Solar	Regenerative, no thermal storage. 10x100 kW units	1.000	Italy (Sicily)	100	\$0.425	Yes	No	Euro	Yes
<b>(Mario Veroli, 2014)</b>	Solar	Regenerative, with thermal storage	1.000	Italy (Sicily)	100	\$0.425	Yes	No	Euro	Yes
<b>(Suresh Baral, 2015)</b>	Solar	Basic with thermal storage	0.006	S. Korea	150	\$0.390	Yes	No	USD	Yes
<b>(Schuster et al., 2009)</b>	Solar CHP	Basic	0.005	Germany	160	\$0.195	Yes	Yes	Euro	Yes
<b>(B. F. Tchanche, Quoilin, Sylvain., 2010)</b>	WHR	Basic WHR	0.002	Belgium	180	\$0.297	Up to price	No	Euro	Yes
<b>(B. F. Tchanche, Quoilin, Sylvain., 2010)</b>	WHR	Basic WHR	0.050	Belgium	180	\$0.289	Up to price	No	Euro	Yes
<b>(Gabrinski P., 2011)</b>	WHR - Biodiesel plant	Basic - isopentane	1.741	Poland	287, 117	\$0.130	No	No	Euro	No

<b>(Gabrinski P., 2011)</b>	WHR - Biodiesel plant	Basic - Isobutane	1.630	Poland	287, 117	\$0.118	No	No	Euro	No
<b>(Schuster et al., 2009)</b>	WHR - Biomass	Regenerative	0.035	Germany	490 - thermal oil	\$0.215	Yes	Yes	Euro	Yes
<b>(Vescovo, 2009)</b>	WHR - Cement	Basic - siloxane	1.800	Undisclosed	250-350	\$0.147	Yes	Yes	Euro	Real results
<b>(Vamshi Avadhanula, 2013)</b>	WHR - Diesel generator jacket water	Basic	0.046	USA (Alaska)	104	\$0.361	Yes, capital support	No	USD	Real results
<b>(Vescovo, 2009)</b>	WHR - Float glass	Basic - siloxane	1.000	Undisclosed	400-500	\$0.155	Yes	Yes	Euro	Real results
<b>(Leonardo Pierobon, 2015)</b>	WHR - Gas turbine	Regenerative ORC	6.040	Denmark	376	\$0.182	No	No	USD	No
<b>(Vescovo, 2009)</b>	WHR - Steel	Basic - siloxane	2.400	Undisclosed	250-350	\$0.098	No	No	Euro	Real results

Table A1.2 part 2: Economic performance of ORC systems in the analyses surveyed.

Study Author	Specific Cost (USD 2014)	DPP (Years)	LEC (\$/kWh) (USD 2014)	EOL NPV / kW output (USD 2014)	Lifetime (Years)	Real Discount rate	Annual O&M Cost	Energy inflation rate	Annual output decrease
(Reisenhofer, 2002)	\$3,834	4.0	\$0.168	4515	10	0.06	0.066	0	0
Gonçalves	\$3,442	infinite	\$1.450	-2719	10	0.06	0.083	0	0
(Holdmann, 2007)	\$6,885	5.0	\$0.137	16354	20	0.06	0.065	0	0
Havidh Nazif	\$2,363	3.0	\$0.066	5278	30	0.05	0.022	0.01	0
Havidh Nazif	\$2,405	3.0	\$0.067		30	0.05	0.022	0.01	0
Havidh Nazif	\$2,839	4.0	\$0.078		30	0.05	0.022	0.01	0
Havidh Nazif	\$2,879	4.0	\$0.079		30	0.05	0.022	0.01	0
Waikite	\$4,330	infinite	\$0.116	-1594	20	0.12	0.065	0.04	0
Cleantech-to-market	\$1,239	2.8	\$0.022	3741	20	0.06	0.020	0	0
Cleantech-to-market	\$1,303	3.2	\$0.023	3235	20	0.06	0.020	0	0
Walrapen et al. (Leuven)	\$5,316	12.0	\$0.053	5516	30	0.04	0.025	0.05	0
Walrapen et al. (Leuven)	\$5,715	13.0	\$0.057	5458	30	0.04	0.025	0.05	0
Mario Veroli, Alfonso Calabria	\$8,559	7.0	\$0.106	11641	25	0.02	0.040	0.025	0
Mario Veroli, Alfonso Calabria	\$6,319	9.0	\$0.106	11683	25	0.02	0.040	0.025	0
Baral et al	\$3,439	3.7	\$0.146	9401	20	0.05	0.020	0.02	0
Schuster	\$10,553	--	\$0.159		15	0.05	0.015	0	0
Tchanche et al.	\$8,570	6.0	\$0.197	12242	20	0.03	0.050	0.02	0.02
Tchanche et al.	\$4,380	2.5	\$0.101	13303	20	0.03	0.050	0.02	0.02
Gabrinski	\$5,556	6.2	\$0.070	4975	14	0.05	0	0	0
Gabrinski	\$5,767	7.0	\$0.073	4004	14	0.05	0	0	0
Schuster	\$6,123	6.0	\$0.092	9585	15	0.05	0.015	0	0
Riccardo Vescovo	\$4,363	<b>4.0</b>	\$0.085	4847	10	0.05	0.008	0	0
V. Avadhanula	\$6,166	2.3	\$0.103	19046	20	0.1	0.027	0	0
Riccardo Vescovo	\$4,254	<b>3.7</b>	\$0.077	5415	10	0.05	0.015	0	0
Leonardo Pierobon	\$2,193	4.9	\$0.054	3247	20	0.1	0.009	0	0
Riccardo Vescovo	\$2,931	<b>4.4</b>	\$0.051	2789	10	0.05	0.009	0	0

**Table A1.3: US-based ORC price index, as formulated in Section 1.5.1.**

<b>Year</b>	<b>ORC (US) Price Index</b>
2000	100.0
2001	100.6
2002	101.8
2003	102.4
2004	104.3
2005	110.6
2006	115.2
2007	121.0
2008	125.4
2009	126.7
2010	126.6
2011	130.4
2012	133.4
2013	135.9
2014	138.1

## Appendix A2

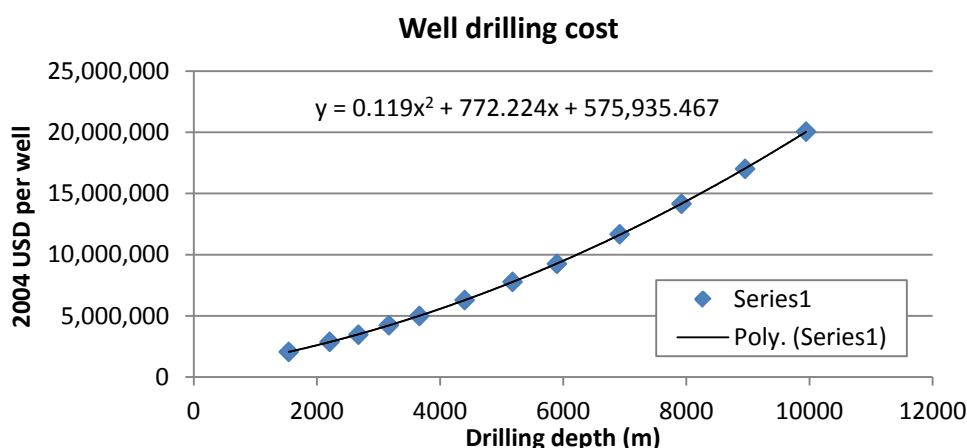

Figure A2.1: Drilling cost of geothermal wells in the US. Data digitised from WellCost Lite model, Massachusetts Institute of Technology. Presented on slide 30 of 'Oil and gas well drilling' (Tester, 2011).

Table A2.1: Outline of calculation procedure to determine average energy input/energy output of forestry production.

	Calculation factor	Value	Unit	Formula / source
A	NZ forestry fuel intensity (2007)	2.62	l/tonne harvest	(OMS, 2008)
A*	Error quoted with A	1.31		(OMS, 2008)
B	NZ forestry production	11,000,000	tonnes	(OMS, 2008)
C1	Total forestry fuel usage (estimate)	28,820,000	litres	B/A
C2	<i>Diesel density = 0.837 kg/l</i>	24,111,771	kg	(GREET, 2010)
C3	<i>Diesel LHV = 42.8 MJ/kg</i>	1.032	PJ	(GREET, 2010)
D	Wood chipping energy use	14.4	MJ/tonne	(Spinelli, 2013)
E	Total wood chipping energy	0.158	PJ	B*D
F	Radiata pine HHV (Woodchips)	20.1	MJ/kg	(Rutherford, 2006)
G	Total biomass heating potential	221.1	PJ	B*F
H	Fuel <sub>th</sub> /Electrical energy efficiency	15%		(Reisenhofer, 2002)
I	Max biomass electricity potential	33.17	PJ	G*H
	<b>Annual input energy to obtain biomass electricity</b>	3.6% ± 1.8%	<b>of energy produced</b>	<b>(E+C3)/I</b>
	<b>Other figures</b>			
J	Diesel used in NZ (2007)	110.83	PJ	(OMS, 2008)
K	Forestry % of diesel use	0.93%		C3/J
L	NZ Electricity production (2007)	141.99	PJ	(MED(NZ), 2011)
M	Potential % electricity from biomass	23.4%		I/L

## Appendix A3

**Table A3.1: Price estimate formulas for common ORC components. All prices given in July 2014 NZD. Component costing process adapted from (Gerrard, 2000) and (Couper, Penney, Fair, & Walas, 2010). Component cost estimates are for the installed price. All prices estimate formulas have been adjusted for July 2014 NZD using the relevant NZ producer price index. Guidelines are included to help provide more accurate estimates.**

Component	Formula	Range	Notes
<b>Heat exchangers</b>			
<i>Shell and tube</i>	$C_{S\&T} = 2140 \times A^{0.578} \times m_f \times I_f$	$4\text{m}^2 < A < 900\text{m}^2$	$I_f$ is typically between 1.4 – 2.2 for shell and tube heat exchangers. Larger units or units with less costly materials tend to have installation factors at the lower end of that range. $m_f$ factors listed in Table A3.2.
<i>Plate and frame</i>	$C_{PL,SS} = 3370 \times A^{0.489} \times I_f$	$A < 20 \text{ m}^2$	For pressures < 12 bar. Higher pressures up to 25 bar can be achieved in plate-and-frame (not welded or brazed) heat exchangers, but at a higher cost. $I_f$ is typically between 1.5 – 2.0 for plate-and-frame heat exchangers.
	$C_{PL,Titanium} = 1140 \times A^{0.691} \times I_f$	$A > 20 \text{ m}^2$	
	$C_{PL,SS} = 5140 \times A^{0.463} \times I_f$		
$C_{PL,Titanium} = 1100 \times A^{0.751} \times I_f$			
<b>Air-cooled condensers</b>	$C_{ACC} = 10950 \times A^{0.40} \times I_f$		$I_f$ is typically around 2.5 for air cooled condensers.
<b>Pumps</b>			
<i>Centrifugal</i>	$C_{Pu} = m_f \times I_f (450 \times V + 2236)$	$0.3 \text{ l/s} < V < 6 \text{ l/s}$	The cost of installing pumps in larger plants is relatively insignificant if low cost materials are used. $m_f$ and $I_f$ factors are listed in Table A3.3.
<b>ORC turbine</b>			
<i>Pressure discharge</i>	$C_{Tu} = I_f \times 1360 \times P^{0.81}$	$15 < P < 4000 \text{ kW}$	The cost estimates for this component vary greatly, especially at smaller sizes, as the market for ORC turbines and expansion machines is very young. A general rule for very rough price estimates is to take a standard turbine price estimate and multiply it by 1.5 to give an optimistic price estimate for favourable flow conditions. (Quoilin et al., 2011). Turbine analysis will quickly indicate whether a turbine above this price estimate



may be necessary.

The installation factor for a turbine is typically 1.5.

**Generator**

$$C_G = 225 \times P \text{ (kW)} + 875 \quad P < 100 \text{ kW}$$

The generator price is generally small compared to the other major components, and is roughly accounted for by the turbine installation factor. The generator cost is more significant for small systems.

Where;

$I_f$  is the installation cost factor.

$m_f$  is the material factor.

**Table A3.2: Illustrative list of material factors for shell and tube heat exchangers**

Shell material	Tube Material	Factor $m_f$
Carbon Steel	Carbon Steel	1.0
Carbon Steel	316 Stainless	2.2
Nickel 200	Nickel 200	5.5
Inconel	Inconel	4.2
Titanium	Titanium	4.0

**Table A3.3: list of material factors for pumps**

Material	Installation Factor	Material Factor
Cast Iron	2.0	1
Cast Iron with	1.9	1.15
SS fittings		
Carbon Steel	1.9	1.35
Stainless Steel	1.5	2.00
Nickel	1.35	3.50
Monel	1.35	3.30
Titanium	1.2	9.70

**Table A3.4: Criteria for supervision and maintenance of boilers in NZ. From NZ OSH boiler safety handbook (Chetwin, 2005)**

Attendance category	Boiler types	Capacity <sup>1</sup>	Notes	Operational supervision			Maintenance	
				By	When	How	By	When
ATTENDED OPERATION	All types	<=20MW	Special conditions apply for manning, controls and alarms	Qualified Operator	Continuously <sup>2</sup>	Normal boiler checks and logging of results	A responsible and experienced person	Manufacturer's recommendations but at least every 3 months
		>20MW						
LIMITED ATTENDANCE OPERATION	Water-tube steam boilers and hot water boilers with a steam or gas head for pressurisation	>6MW	Formal ISO 9000 series standards Quality Management System to apply	Qualified Operator	4-hourly intervals max	Normal boiler checks and logging of results	Approved maintenance contractor <sup>3</sup>	Manufacturer's recommendations but at least every 3 months
	All types	<=6MW max pressure 17bar	Quality Management System to apply (see 1.31) or operation and management system	Qualified Operator	8-hourly intervals max			
UNATTENDED OPERATION	Water-tube steam boilers and hot water boilers with a steam or gas head for pressurisation	No limit	An ISO 9000 series Quality Management System to apply	Responsible person	24-hourly intervals max	Normal boiler checks and either logging of results every 24 hours or data logger printout	Approved maintenance contractor <sup>3</sup>	Manufacturer's recommendations but at least every 3 months
	Shell boilers	<=6MW Max pressure 17bar	Quality Management System to apply (see 1.31) or operation and management system					
	Once through forced circulation boilers	Existing >1.2MW New >3MW						
UNDER 15HP SHELL BOILERS	Not suitable to be upgraded (clause 1.2 and 1.7)	<=14.9HP (1.2MW) Max pressure 17bar	Only run under existing conditions. Not suitable for upgrading to limited attendance or unattended operation	Responsible person	2-hourly intervals max	Normal boiler checks and logging of results	A responsible and experienced person	Manufacturer's recommendations but at least every 3 months
	Suitable to be upgraded (clause 1.2 and 1.7)	<=14.9HP (1.2MW) Max pressure 17bar	May be upgraded to unattended operation	Responsible person	Intervals as authorised following upgrade			
ONCE THROUGH FORCED CIRCULATION COIL BOILERS	Existing	<=14.9HP (1.2MW)	Full compliance with this code of practice	Responsible person	Continuously <sup>2</sup>	Normal boiler checks and logging of results	Approved maintenance contractor <sup>2</sup>	Manufacturer's recommendations
	New	<=3MW						
	Existing and new	All other coil boilers	Full compliance with this code of practice	Qualified Operator				

**Table 1.3 continued**

Attendance category	Boiler types	Capacity <sup>1</sup>	Notes	Operational supervision			Maintenance	
				By	When	How	By	When
SMALL BOILERS	P max = 10bar V max = 1500litres	<500KW	Special considerations apply for controls and instruments	Responsible person				Manufacturer's recommendations but at least every 3 months
PRESSURISED HOT WATER BOILERS	Fully-flooded hot water boilers	No upper limit. Operating above 100°C and 200kPag		Responsible person	As appropriate	Normal boiler checks and logging of results	A responsible and experienced person	
UNFIRED WASTE HEAT BOILERS and HRSG (Heat recovery steam generators)	Water tube or shell	No limit	Controls as per this code	Responsible person	4-hourly max	Normal boiler checks and logging of results	Approved maintenance contractor <sup>3</sup>	Manufacturer's recommendations

Notes:

1. Capacity denotes maximum power output that can be derived from the boiler.

2. Not necessarily continuous, but sufficiently frequent to ensure that the attendant will observe and take action in as short a time as possible on any malfunction or change in conditions that may occur.

3. See Clause 1.4 Definitions. A permitted partial exception is given in 1.28.2.1.

**Table A3.5: Assumed U-values for heat exchanger models.**

<b>Heat transfer direction</b>	<b>U-value (W/K.m<sup>2</sup>)</b>
Water → organic liquid	600
Water → boiling organic	500
Water → organic vapour	150
Organic vapour → water	200
Condensing organic → water	764
Organic liquid → water	714

## Appendix A4

**Table A4.1: Seasonal adjustment factors to calculate the annual return of ORCs at various heat source temperatures. To be used with Equation 4.1.**

Heat source temperature	Cooling type		
	Air (ACC)	Evaporative water	Once-through water
70 °C	-1.27%	-0.84%	-0.79%
100 °C	-0.82%	-0.54%	-0.46%
130 °C	-0.61%	-0.40%	-0.33%
160 °C	-0.49%	-0.32%	-0.25%

**Table A4.2: Main components of the ORC-C system, their weight and main materials. From (Mills C., 2013) and own study.**

Component	Weight	Main Materials
Expander	9.1	Aluminium, Steel
Generator	17.0	Steel, Copper
Evaporator	36.8	Steel
Condenser	11.2	Steel
Buffer tank	3.3	Steel
Working fluid pump	4.8	Steel, Brass
Working fluid pump motor	3.3	Steel, copper
Thermal oil pump	5.2	Steel
Thermal oil pump motor	2.1	Steel, copper
Piping	2.1	Steel
Framing	14.5	Steel
<b>TOTAL</b>	<b>109.4</b>	<b>kg/kW</b>

**Table A4.3: Estimated economic parameters for new Coal and Binary power generation, with prices roughly in 2014 NZD. Fuel cost adapted from (EIA, 2012). CO<sub>2</sub> emissions from (Schlömer S., 2014). Capital costs adapted from (MED(NZ), 2013) and varied slightly along with O&M costs in order to provide a clear example. These parameters are assumed to remain constant over time.**

Estimated economic parameters	Generation Type		
	Coal	Binary	Difference
Capital cost	3500	7000	+3500
Capacity factor	90%	92%	+2.0%
Fuel cost (c/kWh)	0.04	0	-0.04 c/kWh
Operation and maintenance cost (as % of capital cost)	2.00%	3.18%	+1.18% (2.36% absolute)
CO <sub>2</sub> (g/kWh)	820	38	-782 g/kWh

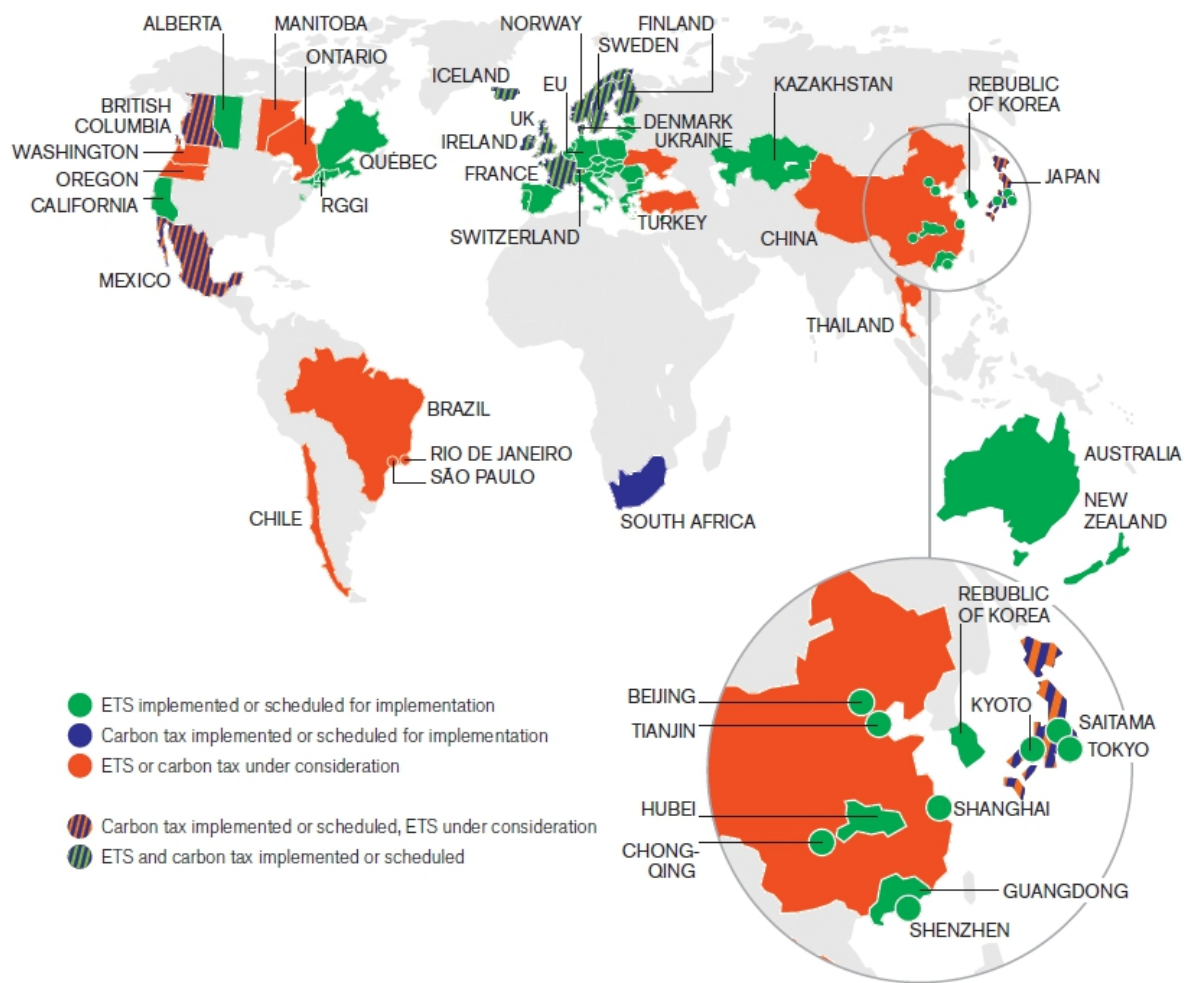

**Figure A4.1: Countries with carbon tax or ETS carbon pricing mechanisms. It should be noted that these schemes differ between regions and that ETS credits are not tradable between all regions. Image from Fig. 1 in ‘State and trends in carbon pricing: 2014’ (World Bank, 2014). Licensed under creative commons attribution CC-BY-3.0.**

**Table A4.4: Estimated CO<sub>2</sub>-equivalent emissions in grams per kWh of electricity produced from (Schlömer S., 2014) and (Weisser, 2007). The ‘%’ column indicates the relative median emissions intensity for each technology when compared to pulverized coal. The ‘cost’ column is the estimated cost in cents/ kWh if a carbon price of \$25/tonne is imposed.**

<b>Current Commercially Available Technologies</b>	<b>Min</b>	<b>Median</b>	<b>Max</b>	<b>%</b>	<b>c/kWh</b>
Coal - pulverised burner	740	820	910	100	2.05
Coal/Biomass co-firing	620	740	890	90	1.85
Gas - CCGT	410	490	650	60	1.23
Biomass - dedicated electricity	130	230	420	28	0.58
Biomass - after re-growth	35	70	99	8.5	0.18
Solar PV - utility scale	18	48	180	5.9	0.12
Solar PV - rooftop	26	41	60	5.0	0.10
Geothermal	6	38	79	4.6	0.10
Concentrated Solar Power	8.8	27	63	3.3	0.07
Hydropower	1	24	2200	2.9	0.06
Wind - offshore	8	12	35	1.5	0.03
Nuclear	3.7	12	110	1.5	0.03
Wind - onshore	7	11	56	1.3	0.03
<b>Potentially significant pre-commercial technologies</b>	<b>Min</b>	<b>Median</b>	<b>Max</b>		
Coal CCS - pulverised	190	220	250	27	0.55
Coal CCS - IGCC	170	200	230	24	0.50
Gas CCS - CCGT	94	170	340	21	0.43
Coal CCS - oxyfuel	100	160	200	20	0.40
Ocean tidal and wave	5.6	17	28	2.1	0.04